



2545847204

Order no. P254 0189 13 Part no. 254 584 72 04  
Edition B-2024



GLC

Mercedes-AMG Supplement

Mercedes-Benz



## Publication details

### Internet

Further information about Mercedes-Benz vehicles and about Mercedes-Benz AG can be found on the following websites:

<https://www.mbusa.com> (USA only)

<https://www.mercedes-benz.ca> (Canada only)

### Documentation team

©Mercedes-Benz AG: Not to be reprinted, translated or otherwise reproduced, in whole or in part, without written permission from Mercedes-Benz AG.

### Vehicle manufacturer

Mercedes-Benz AG

Mercedesstraße 120

70372 Stuttgart

Germany

As at 24.04.23

### Thank you for purchasing a Mercedes-AMG

Before your first drive, please read this Operator's Manual carefully and familiarize yourself with your vehicle. For your own safety and a longer service life of the vehicle, follow the instructions and warning notices in this Operator's Manual. Disregarding them may lead to damage to the vehicle or injury to people.

Damage to the vehicle resulting from the disregard of the instructions is not covered by the Mercedes-Benz Limited warranty.

The standard equipment and product description of your vehicle may vary and depends on the following factors:

- Model
- Order
- National version
- Availability

Your vehicle may therefore differ from that shown in the descriptions and illustrations in individual cases.

Mercedes-AMG reserves the right to introduce changes in the following areas:

- Design
- Equipment
- Technical features

The following documents are integral parts of the vehicle:

- Digital operator's manual
- Printed Operator's Manual
- Maintenance Booklet
- Supplementary manuals relating to specific equipment
- Supplementary documents

Keep these documents in the vehicle at all times. Ensure that all documents are in the vehicle or passed on in the event of sale or rental.

Mercedes-Benz USA, LLC

Mercedes-Benz Canada, Inc.

A Mercedes-Benz Group AG Company

2545847204





<b>Symbols</b> .....	3	<b>Driving and parking</b> .....	12	Permissible towing methods (Mercedes-AMG E Performance) .....	44
<b>At a glance</b> .....	4	Driving .....	12	<b>Wheels and tires</b> .....	45
Cockpit .....	4	DYNAMIC SELECT .....	16	Changing a wheel .....	45
<b>General notes</b> .....	6	Automatic transmission .....	20	Collapsible spare wheel .....	45
Operator's Manual .....	6	Driving and driving safety systems .....	22	<b>Technical data</b> .....	47
Protection of the environment .....	6	<b>Driver's display</b> .....	30	Operating fluids .....	47
Operating safety .....	6	Notes on the driver display .....	30	Vehicle data .....	50
Qualified specialist workshop .....	8	Operating the driver display .....	31	Trailer hitch .....	54
Notes for persons with electronic medical aids .....	8	Driver display menus .....	32	<b>Display messages and warning/indicator lamps</b> .....	57
<b>Occupant safety</b> .....	9	Overview of status indicators on the driver display (Mercedes-AMG vehicles) .....	36	Display messages .....	57
Restraint system .....	9	<b>MBUX multimedia system</b> .....	38	Warning and indicator lamps .....	59
Seat belts .....	9	AMG TRACK PACE .....	38	<b>Index</b> .....	62
<b>Climate control</b> .....	10	<b>Maintenance and care</b> .....	43		
Pre-entry climate control when the vehicle is unlocked .....	10	Notes on the care of tailpipes .....	43		
		<b>Breakdown assistance</b> .....	44		
		Removing the warning triangle .....	44		
		Notes on starting assistance .....	44		

In this Operator's Manual, you will find the following symbols:

 **WARNING** Danger due to failure to observe the warning notices

Warning notices draw your attention to hazards that may endanger your health or life, or the health or life of others.

 Observe the warning notices.

 **ENVIRONMENTAL NOTE** Environmental damage due to failure to observe environmental notes

Environmental notes include information on environmentally responsible behavior or environmentally responsible disposal.

 Observe environmental notes.

 **NOTE** Damage to property due to failure to observe notes on material damage

Notes on material damage inform you of risks which may lead to your vehicle being damaged.

 Observe notes on material damage.

 These symbols indicate useful instructions or further information that could be helpful to you.

 Instruction

(→ page) Further information on a topic

**Display** Display in the central display

 Highest menu level, which is to be selected in the multimedia system

 Relevant submenus, which are to be selected in the multimedia system

\* Indicates a cause

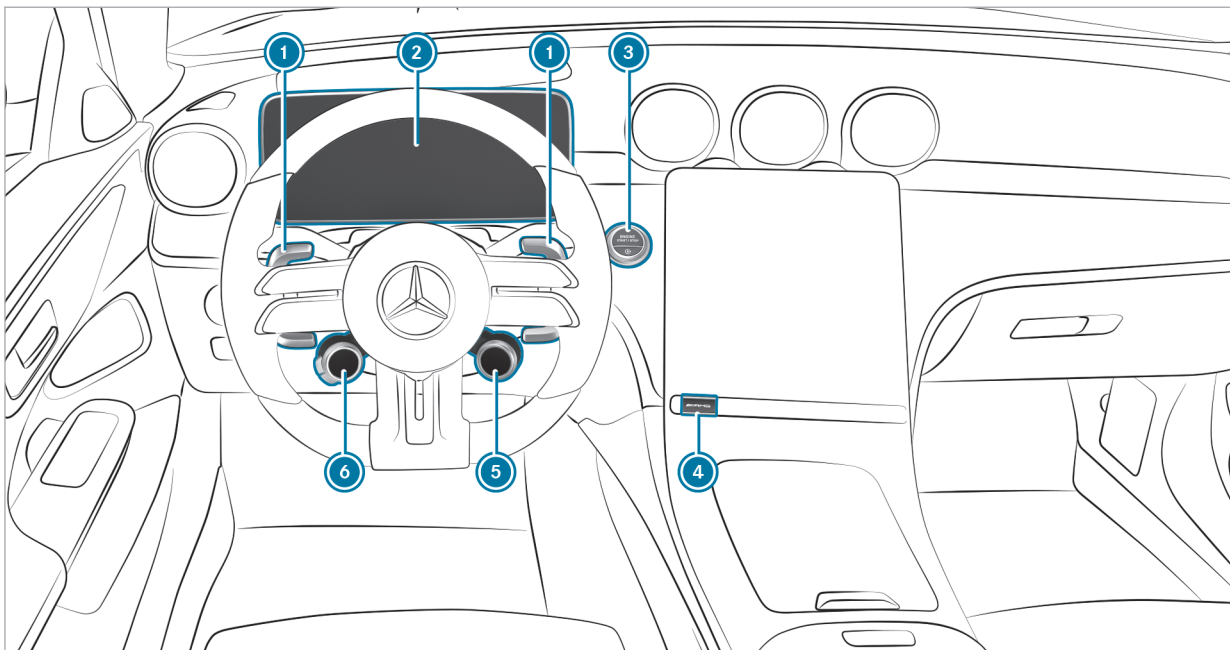

Left-hand-drive vehicles

①	Steering wheel paddle shifters	→	21
②	Driver display	→	31
③	 Start/stop button		
④	Sets AMG DYNAMIC SELECT in the MBUX multimedia system	→	20

⑤	Selects the drive program	→	18
	Plug-in hybrid: sets recuperation	→	14
⑥	AMG steering wheel buttons	→	13

### Operator's Manual

This supplement provides information pertaining to all important functions in your AMG vehicle, which is either not included in, or deviates from, the information provided in your vehicle Operator's Manual. This information supplements or replaces the corresponding sections in the vehicle Operator's Manual. Under no circumstances does the supplement replace the printed vehicle Operator's Manual and the Digital Operator's Manual in the vehicle.

This supplement and the Digital Operator's Manual in the vehicle describe the following models, as well as standard and special equipment of your vehicle:

- The models and the standard and special equipment available at the time of going to press with this supplement.
- The models and the standard and special equipment only available in certain countries.
- The models and the standard and special equipment which will only become available at a later date.

Please note that your vehicle may not be installed with all features described. This also applies to systems relevant to safety. The equipment on your vehicle may therefore differ from that in the descriptions and illustrations.

The original purchase agreement for your vehicle includes a list of the equipment in your vehicle at the time of delivery.

Should you have any questions concerning equipment and operation, please consult an authorized Mercedes-Benz Center.

The Operator's Manual, supplement, further supplementary documents and service booklet are important documents and should be kept in the vehicle.

### Protection of the environment



**ENVIRONMENTAL NOTE** Environmental pollution caused by irresponsible disposal of the high-voltage battery

A high-voltage battery contains materials which are harmful to the environment.

▶ Dispose of defective high-voltage batteries at a qualified specialist workshop.

### Operating safety

Hybrid vehicles have a combustion engine and at least one electric motor. The voltage supply for operating the vehicle electrically is provided by the vehicle's high-voltage electrical system.

**⚠ DANGER** Risk of death and fire due to modified and/or damaged components of the high-voltage on-board electrical system

The vehicle's high-voltage on-board electrical system is under high voltage. If you modify component parts in the vehicle's high-voltage on-board electrical system or touch damaged component parts, you may be electrocuted. In addition, modified and/or damaged components may cause a fire.

In the event of an accident or impact to the underbody, components of the high-voltage



electrical system may be damaged although the damage is not visible.

- ▶ Never make any modifications to the high-voltage on-board electrical system.
- ▶ Do not switch on or use the vehicle if its high-voltage on-board electrical system components have been modified or damaged.
- ▶ Never touch damaged components of the high-voltage on-board electrical system.
- ▶ After an accident, do not touch any components of the high-voltage on-board electrical system.
- ▶ After an accident, have the vehicle transported away.
- ▶ Have the components of the high-voltage on-board electrical system checked at a qualified specialist workshop and replaced if necessary.

The components of the vehicle's high-voltage electrical system are marked with yellow warning

stickers. The cables of the vehicle's high-voltage electrical system are orange in color.

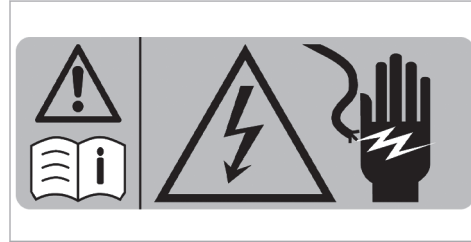

Example

High-voltage components that can become very hot are marked with an additional warning sticker:

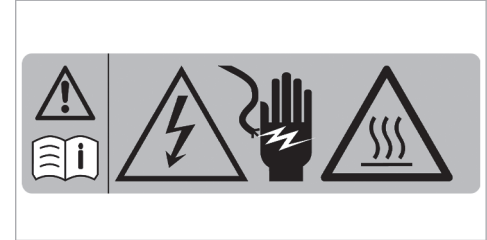

Vehicles with hybrid systems generate significantly less noise when stationary and when being driven than vehicles with combustion engines.

When you are driving in electric mode, the vehicle may not be heard by other road users due to the significantly lower noise generated when they are being driven and when stationary.

It is for this reason that the vehicle is equipped with a sound generator, which serves as an acoustic vehicle alerting system (AVAS). This safety system is prescribed by law.

The outside sound produced by the sound generator (AVAS) can be heard in the passenger com-

partment at low speeds and does not represent a malfunction.

#### Qualified specialist workshop

Always have the following work carried out on your vehicle at a qualified specialist workshop:

- Safety-relevant works
- Service and maintenance work
- Repair work
- Modifications as well as installations and conversions
- Work on electronic components
- Work on the hybrid system

#### Notes for persons with electronic medical aids

When charging the high-voltage battery, keep a distance of at least an arm's length between the medical aid and the following components:

- The power supply equipment

This includes charging stations in the form of a wallbox or a public charging point, for example.



- Vehicle components carrying live voltage

This includes the charging cable and the charging control box, for example.

## Restraint system

### Malfunctioning restraint system

A malfunction has occurred in the restraint system if:

- The  restraint system warning lamp does not light up when the vehicle is switched on
- The  restraint system warning lamp lights up continuously or repeatedly during a journey

If the restraint system is malfunctioning, in the event of an accident the high-voltage on-board electrical system may not be deactivated as intended.

**⚠ DANGER** Risk of death due to the restraint system malfunctioning

Components in the restraint system may be activated unintentionally or not deploy as intended in an accident. In the event of an accident, the high-voltage on-board electrical system may not be deactivated as intended.

You may receive an electric shock if you touch the damaged components of the high-voltage on-board electrical system.

- ▶ Have the restraint system checked and repaired immediately at a qualified specialist workshop.
- ▶ After an accident, switch off the vehicle immediately.

## Seat belts

### Limitations of the protection provided by the seat belt

The AMG sports seat and the AMG Performance seat are designed for the standard three-point seat belt. If you install a different multipoint seat belt, for example a four-point seat belt, the restraint system cannot provide the intended level of protection.

Depending on the type of vehicle, there may be openings in the seat backrest. These openings have no function.

**⚠ WARNING** Risk of injury or fatal injury due to modified seat belt systems

If you feed seat belts through the opening in the seat backrest, the seat backrest may be damaged or may even break in the event of an accident.

- ▶ Only use the standard three-point seat belt.
- ▶ Never modify the seat belt system.

### Pre-entry climate control when the vehicle is unlocked

#### Function of pre-entry climate control when the vehicle is unlocked

The seats can be briefly preheated or precooled before you get into the vehicle.

Depending on the vehicle's equipment, the following functions will be activated as needed during precooling:

- Automatic climate control
- Blower
- Seat ventilation

Depending on the vehicle's equipment, the following functions will be activated as needed during preheating:

- Automatic climate control
- Blower
- Seat heating
- Steering wheel heater
- Panel heating

- Mirror heater
- Rear window defroster

#### Setting pre-entry climate control when the vehicle is unlocked in the multimedia system

Multimedia system:

↳ [Climate Menu](#) ▶▶ [Pre-entry Climate Ctrl.](#)

ⓘ This function is available only for plug-in hybrid vehicles.

▶ Activate or deactivate the function.

#### Selecting seats

▶ Select [Driver](#), [Passenger](#), [Rear Left](#) or [Rear Right](#).

The seat-specific functions of pre-entry climate control (e.g. seat heating) will be performed for the selected seats.

When pre-entry climate control is enabled, an LED on the climate bar on the central display will light up blue for a cooled vehicle and red for a heated vehicle.

#### Activating/deactivating pre-entry climate control when the vehicle is unlocked

##### Requirements

- The high-voltage battery is charged sufficiently.
- The function has been activated via the multimedia system.

▶ **To switch on:** unlock the vehicle. The climate control functions are activated for up to five minutes for pre-heating and pre-cooling.

Pre-entry climate control when the vehicle is unlocked cannot be activated more than twice when the vehicle is switched off.

▶ **To switch off:** press  on the climate bar on the central display (see Operator's Manual for the vehicle).

Depending on the vehicle equipment, the following functions will remain active once the vehicle has been started:

- Seat heating

- Seat ventilation
- Panel heating

## Driving

### Notes on plug-in hybrids

Observe the notes on plug-in hybrids in the Operator's Manual, otherwise you may fail to recognize potential dangers.

#### Notes on plug-in hybrid operation

- The model **Mercedes-AMG GLC 63 S E PERFORMANCE** can be accelerated electrically up to a speed of approximately 77 mph (125 km/h).
- In the drive programs **[C]** and **[B]**, the hybrid system selects the appropriate drive type depending on the driving situation (→ page 16).
- In the drive program **[EL]**, the vehicle drives entirely electrically, and in the drive programs **[S]**, **[S<sup>-</sup>]** and **[S<sup>+</sup>]**, the combustion engine is always on.
- In addition to continued travel with the combustion engine, increased resistance of the haptic accelerator pedal also signals the switch to drive program **[C]**.

#### Charge the high-voltage battery

Refer to the instructions for charging the high-voltage battery in the Operator's Manual to avoid damage and accelerated aging.

- ① If you use the high-voltage battery exclusively with low states of charge, fully charge the high-voltage battery every six months.

Depending on the respective equipment and national version, your vehicle is equipped with a vehicle socket type 1 or type 2 for single-phase AC charging.

Charging options for the high-voltage battery (mode 2 or 3):

- during travel by means of recuperation
- Stationary AC charging:
  - at a mains socket (mode 2)
  - at a wallbox or charging station (mode 3)

#### Notes on engine output and engine torque (Mercedes-AMG vehicles)

- ① The actual (maximum) values that can be achieved for engine output and engine torque

may deviate from the certified values within the country-specific provisions for permissible tolerances (basis: UN-ECE No. 85 or country-specific provisions).

Influencing variables that can influence this are, for example:

- Location above sea level
- Fuel grade
- Outside temperature
- Operating temperature of the engine

Until the engine has reached its operating temperature, the  engine operating temperature warning lamp is lit.

Engine output and engine torque have been reduced. Take this into account in your driving style.

When the engine operating temperature warning lamp  goes out, full engine output and full engine torque are available.

## Function of the AMG steering wheel buttons

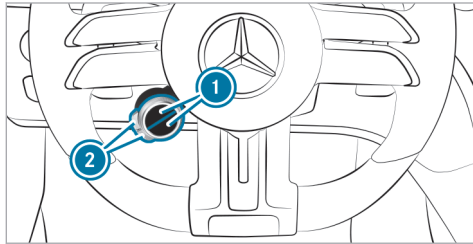









The AMG steering wheel buttons are an additional control element with two buttons on the steering wheel.

You can assign two vehicle functions of your choice to the control element. You can change between the available functions for corresponding button ① by pressing the upper or lower part of display buttons ② repeatedly. Display buttons ① show each function selected.

The following functions are available depending on the equipment:

 ESP® (→ page 22)

-  AMG RIDE CONTROL (→ page 28)
- AMG ACTIVE RIDE CONTROL (→ page 29)
-  Manual gearshifting (→ page 21)
-  ECO start/stop function (→ page 14)
-  AMG Real Performance Sound (→ page 15)
-  **Plug-in hybrid:** AMG Real Performance Sound (→ page 15)
-  Camera views (see the vehicle's Operator's Manual)
-  AMG DYNAMICS (→ page 16)
-  **Plug-in hybrid:** Boost strategy (→ page 27)

In addition, all the functions you have saved as favorites in the multimedia system will be available for selection. Information on favorites in the multimedia system and their configuration (see the vehicle's Operator's Manual).

- ① Individual functions may be faded out. How functions are displayed and the order in which

they are displayed can be set in the multimedia system (→ page 13).

If you have assigned a specific function to one of display buttons ①, you will be able to operate that function with corresponding button ②.

The assignment of display buttons ① will remain stored even after the vehicle has been started again. The operating status of the respective function will, however, be reset to the basic setting.

## Setting the AMG steering wheel buttons

Multimedia system:

- ➔  ➔ Settings ➔ System
- ➔ Control Elements
- ➔ AMG Steer. Wheel Buttons

The left display buttons on the steering wheel can be set in the **SETTINGS SELECT** menu.

- ▶ Press  and select the desired function from the list.
- The selected function is assigned to the corresponding display button and can now be called up directly by simply pressing it.

### Deleting button assignment

- ▶ Select the upper or lower display button and switch to editing mode by pressing and holding it.
- ▶ Press  to delete the selected display button assignment.

### Switching the ECO start/stop function on/off (Mercedes-AMG vehicles)

Observe the notes on the ECO start/stop function in the vehicle Operator's Manual.

- i** **Plug-in hybrid:** the ECO start/stop function is not available.
- i** You can also switch the ECO start/stop function on or off via the steering-wheel button or via the multimedia system.

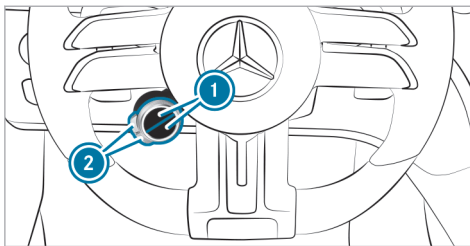



- ▶ Press upper or lower display button **1** repeatedly, until it displays the  symbol.

- i** If the display button does not show the symbol, then it is hidden. How functions are displayed and the order in which they are displayed can be set in the multimedia system (→ page 13).

- ▶ Press corresponding button **2**.





The symbol indicates the current status of the ECO start/stop function:

-  (red): switched off
-  (green): activated
-  (yellow): inactive

### Recuperative brake system (plug-in hybrid)

#### Setting recuperative deceleration manually (Mercedes-AMG vehicles)

#### Requirements

- Drive program , , ,  or  is selected.
- ESP® is activated – ESP® ON.
- Active Distance Assist DISTRONIC is not activated.

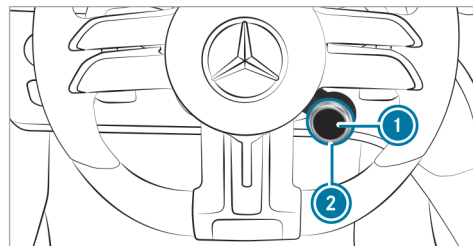

The higher the recuperation, the more sharply the vehicle is braked when coasting and the more



electrical energy is fed into the high-voltage battery.

**i** When the vehicle is started again or transmission position **D** is engaged again, standard recuperation is automatically set.

▶ Press display button **1**.

The display button shows the  symbol with a three-part segment display for setting the recuperation.





**i** If the display is grayed out, the requirements are not met and setting is not possible. If the potential to charge the high-voltage battery is reduced, for example due to a high charge level or because the high-voltage battery is not yet at operating temperature, a recuperation level may not be able to be set at that time. The **Desired Recuperation Level Currently Unavailable** message is then shown in the driver display.

When the  symbol is shown with a red ! on the display button, the regenerative brake system is malfunctioning. Observe the information on warning lamps and display messages which are shown in the driver display.

▶ **To increase recuperation:** turn rotary switch **2** clockwise in the **+** direction.

▶ **To decrease recuperation:** turn rotary switch **2** counter-clockwise in the **-** direction.

The following recuperation levels are available and are shown on display button **1**:

-  and no segments light up: no recuperation, the vehicle rolls freely
-  and one segment lights up: standard recuperation
-  and two segments light up: increased recuperation, strong deceleration in overrun mode, e. g. for driving on downhill gradients
-  and three segments light up: maximum recuperation, maximum deceleration in overrun mode

**i** In drive programs **EL**, **C** and **B**, the intensity of the recuperation is adjusted as needed for downhill gradients: the steeper the incline, the higher the recuperation. Depending on the situation, it may nevertheless be necessary to additionally depress the brake pedal.

If the charge potential of the high-voltage battery has to be reduced due to an increasingly high charge level, for example, when driving downhill for a long time, the recuperation level is automatically reduced. The **Recuperative Deceleration Temporarily Reduced** message is then shown in the driver display.

## AMG Real Performance Sound

### Selecting a sound characteristic with the steering-wheel button

**i** You can select a comfortable (Balanced) or a sporty (Powerful) sound characteristic using the steering-wheel button or the multimedia system (→ page 20).

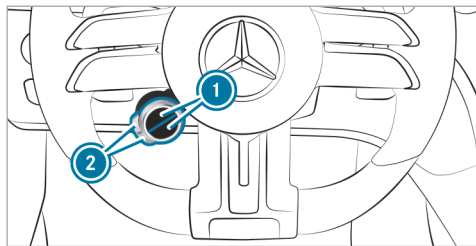

▶ Press upper or lower display button ① repeatedly until it displays the  symbol.

**Plug-in hybrid:** display button ① will show the  symbol for the sound characteristic.

① If the display button does not show the symbol, then it is hidden. How functions are displayed and the order in which they are displayed can be set in the multimedia system (→ page 13).

▶ Press corresponding button ②.

The color of the button symbol indicates the currently selected sound characteristic:

- **Blue:** Balanced – comfortable

- **Red:** Powerful – sporty

① **Plug-in hybrid:** With the sporty sound characteristic (Powerful), the vehicle will produce speed-dependent driving noise up to approximately 62 mph (100 km/h).

### Information on the AMG ceramic high-performance composite brake system

The brake system is designed for heavy loads. This may lead to noise when braking. This effect can also occur after washing the vehicle.

The noise depends on the following factors:

- speed
- brake force
- environmental conditions, e.g. temperature and air humidity

① Have the brake system checked at a qualified specialist workshop after it has been subjected to extreme loads.



## DYNAMIC SELECT

### Function of DYNAMIC SELECT (Mercedes-AMG vehicles)

DYNAMIC SELECT allows a drive program to be selected quickly according to the current driving conditions or the desired vehicle characteristics.

① Depending on the engine and equipment, the vehicle will have different drive programs.

You can select the following drive programs:

-  **Slippery**
  - Optimized pulling-away and driving characteristics in wintry and slippery road conditions
  - Drive with combustion engine only (plug-in hybrid)
-  **Battery Hold** (plug-in hybrid)
  - Prioritizes maintaining the state of charge of the high-voltage battery, e.g. for subsequent journeys in inner cities/low-emission zones

- The hybrid system will select the appropriate drive type depending on the driving conditions
- **EL** **Electric** (plug-in hybrid)
  - Electric mode: driving without the combustion engine is possible up to approximately 77 mph (125 km/h).
  - Limits the maximum set speed for cruise control or Active Distance Assist DISTRONIC to the maximum speed possible in electric mode
  - Activates the combustion engine and changes to the **C** drive program via the first point of resistance of the haptic accelerator pedal
- **C** **Comfort**
  - Comfortable and economical driving
  - The hybrid system will select the appropriate drive type depending on the driving conditions (plug-in hybrid)
- **I\*** **Individual**
  - Customized settings for drive, suspension, steering and ESP®
- **S** **Sport**
  - Sporty driving
  - Balance between stability and sportiness
  - Suitable only for good road conditions, a dry surface and a clear stretch of road
  - Drive with the combustion engine and reinforced boost effect (plug-in hybrid)
- **S\*** **Sport+**
  - Particularly sporty driving
  - Emphasizes the vehicle's own oversteer and understeer characteristics
  - Suitable only for good road conditions, a dry surface and a clear stretch of road
  - Drive with the combustion engine and reinforced boost effect (plug-in hybrid)
- **R** **Race**
  - Maximum sportiness

- Driving characteristics suited for the race-track with maximum or racetrack-optimized boost effect (plug-in hybrid)
- Particularly firm suspension tuning
- Sporty sound from the exhaust system



**i** The **R** drive program is available only for the **Mercedes-AMG GLC 63 S E Performance** model and for vehicles with the **AMG DYNAMIC PLUS package**.



The **R** drive program offers driving characteristics suited to the racetrack and must not be used on normal roads. The **R** drive program may be activated and used only on dedicated race circuits, not on public roads.

**Plug-in hybrid:** if the boost strategy is activated in the **R** drive program, the electric drive output will be metered in a way that is optimized for a racetrack. It will then be possible to use the maximum boost effect only deliberately via kickdown (→ page 27).

Mercedes-AMG recommends selecting drive program **C** when in city traffic or stop-and-go traffic.

Depending on the drive program selected, the following vehicle characteristics will change:



- Drive
  - Energy supply for the electric drive output (plug-in hybrid)
- AMG DYNAMICS
  - The four agility functions, Basic, Advanced, Pro and Master, will be selected automatically depending on the drive program.
  - The steering, shift timing point, all-wheel drive and stabilization functions will be adapted to the selected drive program.
  - When ESP® is activated, the Pro agility function will be selected in drive program . The Master function will be selected automatically when ESP® is switched to SPORT  or is switched off .
- Real Performance Sound
- Sound of the drive system in the vehicle interior
- Suspension
- Steering

- Availability of Glide mode
  -  You can set the drive program characteristics using the multimedia system (→ page 20).
  -  You can adjust certain agility functions of AMG DYNAMICS using the AMG steering-wheel buttons.

### Select driving mode (Mercedes-AMG vehicles)

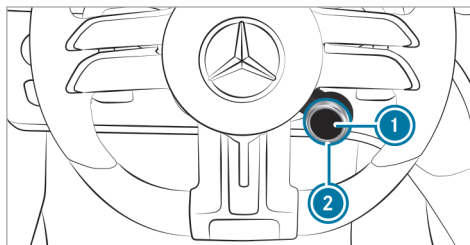



#### Selection with right-hand steering wheel button



- ▶ Turn the rotary-type switch . The selected driving mode will appear on the display button  and on the driver display.

-  Some driving modes may be hidden. The display of the driving modes and their order can be set in the multimedia system (→ page 20).

▶ To select the driving mode  directly: press display button .

-  **Plug-in hybrid:** Direct selection of the driving mode  by pushing the display button  is not possible. In a plug-in hybrid, you use the display button  to set the regeneration level (→ page 14).

### Selection via the central display (multimedia system)

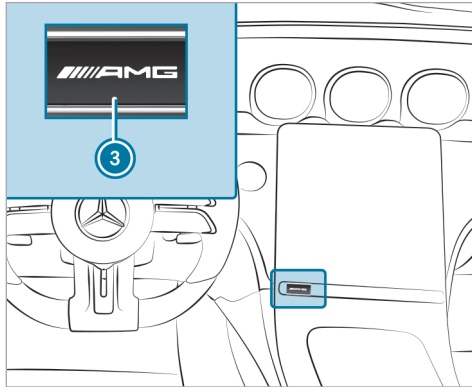

- ▶ Push the button ③ and select the driving mode via the central display (→ page 20).

### Configuring DYNAMIC SELECT in the multimedia system

Multimedia system:

- ▶ → ▶ Settings ▶ Vehicle
- ▶▶ DYNAMIC SELECT

#### Setting drive program I

- ▶ Select Individual.
- ▶ Select and set a category.

#### Switching the reset display on/off

- ▶ Activate or deactivate **Request at Start**.
- ① This function must be activated for each user profile separately. Only when this function is activated will the drive program and ECO start/stop setting for the previous journey be saved for the respective user profile.

**Function on:** the next time the vehicle is started a prompt appears asking whether the last active drive program should be restored. If the ECO start/stop function was deactivated, an additional prompt appears asking if the function should remain deactivated.

- ① The prompt appears only if the previously active settings deviate from the standard settings.

**Function off:** the next time the vehicle is started the drive program is set automatically. The ECO start/stop function is activated automatically.

#### Switching the reset display on/off (plug-in hybrid)

- ▶ Activate or deactivate **Request at Start**.
- ① This function must be activated for each user profile separately. The drive program for the respective user profile of the last driver is only stored if this function is activated.

**Function on:** the next time the vehicle is started a prompt appears asking whether the last active drive program should be restored.

- ① The prompt appears only if the previously active settings deviate from the standard settings.

## Setting AMG DYNAMIC SELECT in the MBUX multimedia system

Multimedia system:

- ➔ [Home] ➔ Settings ➔ Vehicle
- ➔ DYNAMIC SELECT

### Overview of the AMG DYNAMIC SELECT menu

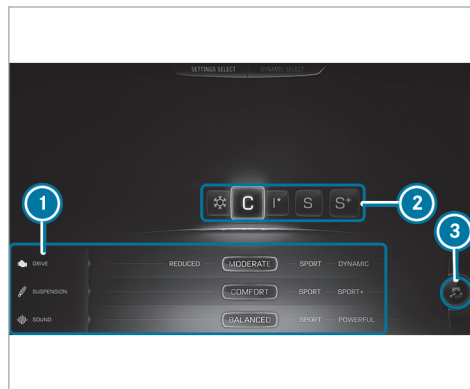

(Example of representation) Representation and arrangement of content equipment-dependent.

- 1 AMG drive program settings
- 2 Drive programs
- 3 ESP® (→ page 22)

- ▶ Select the appropriate drive program.

The settings of the drive programs can be adjusted individually.

- ▶ Select the desired tab on the left and make the relevant setting.

Setting options for the drive programs (equipment-dependent):

- Suspension:  
Comfort/Sport/Sport+

### Automatic transmission

#### Rocking the vehicle free

Rocking the vehicle back and forth may help to free the vehicle if it has become stuck in slush or snow.

To rock the vehicle free, move the DYNAMIC SELECT selector lever up and down past the pressure point in order to switch back and forth between transmission positions **D** and **R**.

- i** The maximum speed for shifting back and forth between **D** and **R** is about 6 mph (9 km/h).

### Manual shifting (Mercedes-AMG vehicles)

- i** You can also activate and deactivate manual gearshifting via the multimedia system (→ page 22).

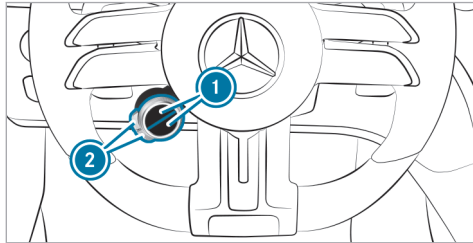



- ▶ Press the upper or lower display button **1** repeatedly, until it displays the symbol .
- i** If the display button does not show the symbol, then it is hidden. How functions are displayed and the order in which they are displayed can be set in the multimedia system (→ page 13).

played can be set in the multimedia system (→ page 13).

- ▶ **To activate/deactivate:** press the corresponding button **2**.

The symbol indicates the currently selected transmission position:

-  **M** (red): manual gearshifting
-  **D** (blue): automatic transmission

**Plug-in hybrid:** automatic transmission must be selected for electric mode. If you select manual mode in drive program **EL**, the drive program will change to **C** and the combustion engine will start. If you are driving in electric mode in drive program **B** or **C** and select manual mode, the combustion engine will start.

### Shifting up and down

- !** **NOTE** Damage to the engine due to shifting up too late

The automatic transmission does not shift up in manual mode even when the engine's limiting speed is reached.

The fuel supply is interrupted in order to prevent the engine from overrevving.

- ▶ Shift up before the engine speed reaches the red area in the tachometer.

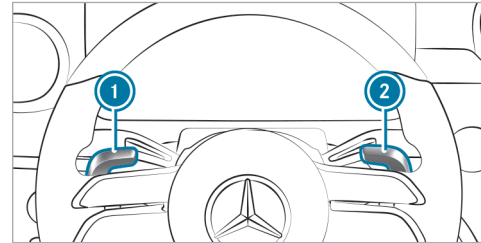

- ▶ **To shift up:** pull steering wheel paddle shifter **2**.
- ▶ **To shift down:** pull steering wheel paddle shifter **1**.

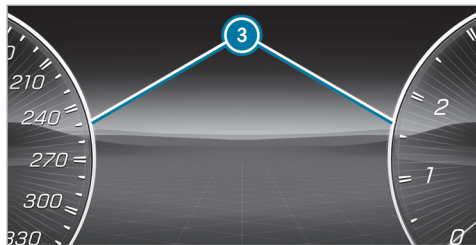

If the engine speed is too high or too low, you will not be able to change gear using the steering wheel paddle shifters. In this case, segments ③ will light up red on the driver's display.

### Permanently activating or deactivating manual gearshifting

Multimedia system:

➔  ➔ Settings ➔ Vehicle ➔ Driving

▶ Permanently switch the function on or off.

### Function of the gliding mode (Mercedes-AMG vehicles)

With an anticipatory driving style, gliding mode helps you to reduce fuel consumption.

When driving in gliding mode, the symbol  appears on the driver display and the combustion engine is turned off. All of the vehicle functions remain active.

Gliding mode is activated if the following conditions are met:

- The ECO start/stop function is switched on.
- Drive program  is selected with the drive setting "Moderate" or "Reduced".
- The speed is within a suitable range.
- The road's course is suitable, e.g. no steep uphill or downhill inclines or tight bends.
- The state of charge of the battery is sufficient.
- You are no longer depressing the accelerator or brake pedal.

Gliding mode is deactivated again if one of the conditions is no longer met.

### Driving and driving safety systems

#### Function of ESP® (Mercedes-AMG vehicles)

You can choose between the following modes of the Electronic Stability Program (ESP®):

- ESP® ON
- ESP® SPORT
- ESP® OFF

#### Characteristics when ESP® is activated

ESP® monitors and improves driving stability and traction, particularly in the following situations:

- When you pull away on wet or slippery road surfaces.
- When you brake.
- **Vehicles with trailer hitch:** in trailer operation from a speed of 40 mph (65 km/h), if the vehicle/trailer combination begins to sway from side to side.
- When there is a strong crosswind and the vehicle's speed is between approximately 50 mph (80 km/h) and 125 mph (200 km/h)



ESP® can stabilize the vehicle by intervening in the following ways:

- Applying the brakes to one or more wheels
- Adapting the engine output according to the situation
- Adapting drive system output depending on the situation

ESP® will be activated every time the vehicle is started, regardless of whether ESP® SPORT or ESP® OFF was selected before the vehicle was switched off.

When the  warning lamp flashes, one or more wheels have reached their grip limit:



- Adapt your driving style to suit the prevailing road and weather conditions.
- Do not deactivate ESP® under any circumstances.
- Depress the accelerator pedal only as far as necessary when pulling away.

### Characteristics of ESP® SPORT

 **WARNING** Risk of skidding if ESP® SPORT is used incorrectly

When you activate ESP® SPORT, there is an increased risk of skidding and having an accident.

 Activate ESP® SPORT only in the circumstances described below.

When ESP® SPORT is selected, the  and  warning lamps will light up continuously.

Select ESP® SPORT when the vehicle's own oversteer and understeer characteristics are desired, e.g. on cordoned-off roads.

Driving with ESP® SPORT or with ESP® deactivated requires an extremely skilled and experienced driver.

If ESP® SPORT is activated and one or more wheels start to spin, the  warning lamp will flash. ESP® then only stabilizes the vehicle to a limited degree.

ESP® SPORT also has the following characteristics:

- ESP® only improves driving stability to a limited degree.
- ETS/4ETS traction control is still active.
- The engine's torque is only restricted to a limited degree and the drive wheels can spin.

The power of the drive system is only restricted slightly according to the situation and the drive wheels can spin.

The spinning of the wheels results in a cutting action for better traction on loose surfaces.



- ESP® continues to provide assistance when the brakes are firmly applied.
- **Vehicles with trailer hitch:** stabilization of the vehicle/trailer combination is no longer active.
- Crosswind Assist is no longer active.

### Characteristics when ESP® is deactivated

**⚠ WARNING** Risk of skidding if ESP® is deactivated

If you deactivate ESP®, ESP® cannot carry out vehicle stabilization.

▶ ESP® should only be deactivated in the following situations.

When ESP® is deactivated, the  and  warning lamps will light up continuously.

Deactivating ESP® has the following effects:

- Driving stability will no longer be improved.
- The drive wheels could spin.
- ETS/4ETS traction control will still be active.
- **Vehicles with trailer hitch:** stabilization of the vehicle/trailer combination will no longer be active.
- Crosswind Assist will no longer be active.

**i** Even when ESP® is deactivated, you will still be assisted by ESP® when braking hard.

It may be best to activate ESP® SPORT or deactivate ESP® in the following situations:

- When using snow chains.
  - In deep snow.
  - On sand or gravel.
- i** Spinning the wheels will cause them to dig in to the surface, thereby enhancing traction.
- i** Activate ESP® as soon as the situations described above no longer apply. ESP® will otherwise not be able to stabilize the vehicle if the vehicle starts to skid or a wheel starts to spin.

If the  warning lamp lights up continuously, ESP® is not available due to a malfunction.

Observe the display messages and warning and indicator lamps that are shown.

- Warning and indicator lamps
- Display messages

### ETS/4ETS (Electronic Traction System)

ETS/4ETS traction control is part of ESP®.

ETS/4ETS can improve the vehicle's traction by intervening in the following ways:

- The brakes will be applied to the drive wheels individually if they spin.
- More drive torque will be transferred to the wheel or wheels with traction.

### Setting ESP® with the steering-wheel button

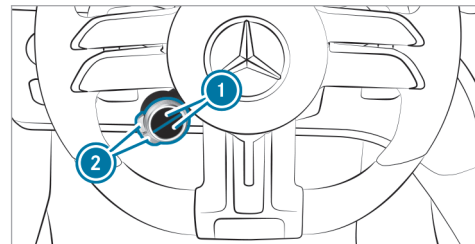

**i** You can also adjust ESP® via the multimedia system (→ page 25).



▶ **To set ESP®:** press upper or lower display button ① repeatedly, until it shows the  symbol.



① If the display button does not show the symbol, then it is hidden. How functions are displayed and the order in which they are displayed can be set in the multimedia system (→ page 13).



The color of the road in the  button symbol indicates the current setting:

-  (blue): ESP® ON
-  (yellow): ESP® SPORT
-  (red): ESP® OFF



▶ **To set ESP® SPORT:** briefly press button ② when ESP® is activated. The road in the  button symbol will light up yellow. The  and  warning lamps will appear on the driver's display.

▶ **To deactivate ESP®:** select ESP® SPORT and then press and hold button ②. The road in the  button symbol will light up red.

The  and  warning lamps will appear on the driver's display.

① When you deactivate ESP®  in the  drive program, AMG Dynamics will automatically switch to the **Master** level.

▶ **To activate ESP®:** briefly press button ② when ESP® SPORT is selected or ESP® is deactivated. The road in the  button symbol will light up blue.

The  and  or  warning lamps will go out.



When the  symbol is shown with a red ! on the display button, ESP® is malfunctioning. Observe the information on warning lamps and display messages that are shown on the driver's display.





## Setting ESP® in the multimedia system



Multimedia system:

→  ► Settings ► Vehicle  
► DYNAMIC SELECT

ESP will always be activated when the vehicle is started. The road in the  button symbol lights up blue.

▶ **To set ESP SPORT:** when ESP is activated, briefly press  to change to the **Sport** program. The road in the  button symbol lights up yellow.

▶ **To deactivate ESP:** set the ESP SPORT program and press and hold  to deactivate ESP. The road in the  button symbol lights up red. The  and  warning lamps appear on the driver's display.

▶ **To activate ESP:** briefly press  in ESP SPORT or if ESP is deactivated. The road in the  button symbol lights up blue.

The  and  or  warning lamps go out.

- ① You can also set ESP via the steering-wheel buttons (→ page 24).

## RACE START

### Information on RACE START

- ① RACE START is available only for the **Mercedes-AMG GLC 63 S E Performance** model and for vehicles with the **AMG DYNAMIC PLUS package**.

RACE START enables optimal vehicle acceleration from a standstill. For this, a suitably high-grip road surface is required, and the tires and vehicle must also be in good condition.

- ① Use RACE START only after the vehicle has been broken in.
- ① RACE START must not be used in normal road operation. RACE START may be activated and used only on dedicated race circuits, not on public roads. Read the safety notes and information on ESP® (→ page 22).

**⚠ WARNING** Risk of skidding and having an accident from wheels spinning



If you use RACE START, depending on the ESP® mode selected, there is an increased risk of skidding and having an accident.

- ▶ Make sure that no persons or obstacles are in the close vicinity of your vehicle.

### Activating RACE START

#### Requirements

- The vehicle is switched on and the transmission and the engine are at normal operating temperature.
- The driver's door is closed.
- The front wheels are in the straight-ahead position.
- The vehicle is on level ground.
- The vehicle is stationary, the brake pedal is depressed (left foot) and the parking brake is released.
- The transmission is in position .

- One of the ,  or  drive programs is selected (→ page 16).

- ▶ Rapidly depress the accelerator pedal fully. The engine speed will increase.

- ① If the activation conditions are not fulfilled, RACE START cannot be used. The **RACE START Not Possible See Operator's Manual** message will appear on the driver display.

- ▶ The **RACE START Release Brake to Start** message will appear on the driver display.

- ① In this phase, you can adjust RACE START depending on the road conditions. You can vary the engine speed by pulling on one of the steering wheel paddle shifters. The segments on the driver display will flicker rapidly.

- ① If the brake pedal is not released after a short while, RACE START will be canceled. The **RACE START Canceled** message will appear on the driver display.

- ▶ Take your foot off the brake, but keep the accelerator pedal depressed. The vehicle will pull away at maximum acceleration. The **RACE START Active** message will appear on the driver display.

RACE START will be deactivated immediately if you release the accelerator pedal during RACE START or if any of the activation conditions is no longer fulfilled. The **RACE START Canceled** message will appear on the driver display.

- ⓘ After being used several times in short succession, RACE START will be unavailable until a certain distance has been driven.

## Boost Strategy

### Function of Boost Strategy

- ⓘ Boost Strategy is only available for the **Mercedes-AMG GLC 63 S E Performance** model.

Boost Strategy is used to increase performance on a race track and can only be selected in drive program .

Boost Strategy is part of AMG TRACK PACE and can be activated either via the steering wheel button (→ page 27) or via the settings for Track Race (→ page 41).

You can set the energy flow and thus the energy supply of the electric drive power depending on the length of the race and its track characteristics.



For long races, activate Boost Strategy to use the maximum boost effect as needed exclusively via kickdown. Deactivate Boost Strategy for short races to always use the maximum electrical power.

### Activating/deactivating Boost Strategy with the steering-wheel button

#### Requirements

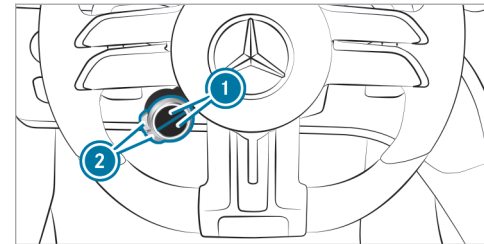
- Drive program  is selected (→ page 16).
- The state of charge of the high-voltage battery is sufficient.
- ⓘ You can also activate or deactivate Boost Strategy via the Track Race settings (→ page 41).



- ▶ Press upper or lower display button  repeatedly, until it displays the  symbol.
- ⓘ If the display button does not show the symbol, then it is hidden. How functions are displayed and the order in which they are displayed can be set in the multimedia system (→ page 13).
- ⓘ If the display is grayed out, the requirements for Boost Strategy are not met and it is not possible to activate the function.
- ▶ Press corresponding button .

The symbol shows the current status:

-  (blue): Boost Strategy is activated

-  (yellow): Boost Strategy is deactivated

When Boost Strategy is activated, the driver's display also shows the  symbol in blue.

With an active boost process via kickdown, the **BOOST** message appears in the driver's display and the  symbols in the driver's display and on the display button light up yellow

## AMG adaptive sport suspension system

### Function of AMG RIDE CONTROL

AMG RIDE CONTROL is an electronically controlled damping system for improved driving comfort and increased driving safety.

The damping is adjusted individually to each wheel and depends on the following factors:

- Driving style, e.g. sporty
- Road condition, e.g. bumps
- Individual selection of **SPORT**, **SPORT +** or **COMFORT**

The suspension tuning is dependent on the selected drive program.

In addition, you can select the setup individually in any drive program with the AMG steering wheel button (→ page 28). The automatic suspension tuning is active again after a change in drive programs.

- When the vehicle is started again, the **COMFORT** setting is activated automatically.

### Selecting the suspension setting

- You can also adjust the suspension setting via the multimedia system (→ page 20).

You can select from three different suspension settings:

- **COMFORT** ensures a comfortable suspension setting. Select this suspension setting if you prefer a comfortable driving style.
- **SPORT** ensures a firmer suspension setting. Select this suspension setting when employing a sporty driving style, e.g. on winding country roads.
- **SPORT +** ensures a very firm suspension setting.

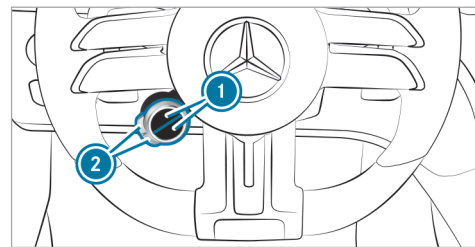



- ▶ Press the upper or lower **1** display button repeatedly, until it displays the  symbol.

- If the display button does not show the symbol, then it is hidden. How functions are displayed and the order in which they are displayed can be set in the multimedia system (→ page 13).

- ▶ Press corresponding button **2**. The selected suspension setting is shown in the driver's display as a message.

The  symbol indicates the currently selected mode:

-  (blue): COMFORT

-  (yellow): SPORT
-  (red): SPORT +

## AMG ACTIVE RIDE CONTROL

### Function of AMG ACTIVE RIDE CONTROL

AMG ACTIVE RIDE CONTROL additionally supplements the functions of AMG RIDE CONTROL with an active roll stabilisation system. Depending on the selected drive program, the suspension setting is adapted to the driving situation by influencing the vehicle's roll behaviour with active stabilisers. As a result, the driving comfort and safety of the vehicle are noticeably improved. The stabilisers on the front and rear axle can also be controlled separately to make the handling more dynamic.

### Suspension setting per drive program

Drive programs , **C**, **EL** and **B**:

- The lean is reduced during cornering.
- Roll movements caused by uneven road surfaces are compensated for.

Drive programs **S** and **S'**:

- The lean is significantly reduced during cornering.
- Roll movements caused by uneven road surfaces are compensated for.
- **S'** and : the driving characteristics become even more agile through targeted interventions.

Drive program **IV**:

- Individual settings of the suspension setting via AMG DYNAMICS
  - Basic: reduction of lean during cornering
  - Advanced: increased reduction of lean during cornering
  - Pro: significantly increased reduction of lean during cornering

## Notes on the driver display

**⚠ WARNING** Risk of accident if the driver's display fails

If the driver's display fails or malfunctions, you may not be aware of any functional limitations to safety-critical systems. This may affect the operating safety of the vehicle.

- ▶ Park the vehicle safely as soon as possible and notify a qualified specialist workshop.

The driver display shows the following basic information:

- Speed, engine speed and power meter level
- Range on map
- State of charge of the high-voltage battery
- Indicator and warning lamps

Additional functions available include the following:

- Various menus, e.g. **Classic**
- Status displays for the driving systems

- Display messages
- Information on electric range and distance **From Start** and **From Reset**



Trip computer (example)

- ① Proportion of driving done in electric mode (distance traveled under electric power per total distance traveled)

Information about range

- The actual range achieved may differ from the range displayed. Your previous driving style will be taken into account when the range is being calculated.

- Factors such as outside temperature or climate control settings have a direct influence on the achievable range.

Electric energy consumption

- The **From Start** and **From Reset** consumption figures take into account all active consumer equipment when it comes to the drive system's operational readiness.

Information on the proportion of driving done in electric mode

- When the proportion of driving done in electric mode is determined, only distances driven under the following conditions will be taken into account:
  - The combustion engine is switched off.
  - The Electric or Hybrid drive program is active.
  - The high-voltage battery is charged.



## Operating the driver display

**⚠ WARNING** Risk of distraction from information systems and communications equipment

If you operate information systems and communication devices integrated in the vehicle when driving, you could be distracted from the traffic situation. This could also cause you to lose control of the vehicle.

- ▶ Only operate this equipment when the traffic situation permits.
- ▶ If you cannot be sure of this, stop the vehicle whilst paying attention to road and traffic conditions and operate the equipment with the vehicle stationary.

Observe the legal requirements for the country in which you are currently driving when operating the driver display.

## Scrolling through the menu bar and calling up a menu

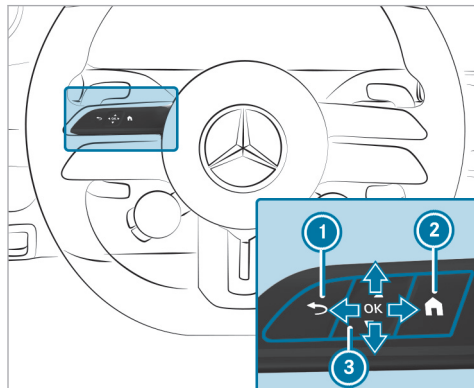

- ① Back button
- ② Main menu
- ③ Touch Control

You can manage the content of the driver display with the controls on the left of the steering wheel. You can navigate the content by swiping vertically

and horizontally with one finger on Touch Control ③. Press the Touch Control to confirm your selection.

- ① To operate Touch Control ③ in the most effective way, use the tip of your thumb if possible. You can also set the sensitivity of Touch Control on the central display.
- ▶ Briefly press main menu button ②.
- ▶ Select a menu by swiping to the left or right on Touch Control ③.
- ▶ **To confirm:** press Touch Control ③.

## Calling up or exiting the **Options** submenu

- ▶ **To call up:** press Touch Control ③.
- ▶ **To exit:** press back button ①.

## Browsing through display content or lists

- ▶ Swipe vertically or horizontally on Touch Control ③.
- ① On some menus, an index character will be displayed at the right edge of the center display content to indicate how the information has been sorted.

### Presetting displays

You can preset individually configured information of a menu and thus determine the standard display.

▶ Press Touch Control **3** until the bar is completely filled.

Answer the **Set Shortcut?** query as follows:

▶ Swipe to the left on Touch Control **3** and select **Yes**.

▶ **To confirm:** press Touch Control **3**.

▶ **To call up presets:** press back button **1** on the upper level of a menu.

**i** Pressing back button **1** on the standard display will open the previous menu.

### Resetting values

▶ **To call up the Options submenu:** press Touch Control **3**.

▶ **To select the function to be reset:** press Touch Control **3**.

▶ Select **Yes**.

▶ **To confirm:** press Touch Control **3**.

### Driver display menu

#### Classic or Understated menu (Mercedes-AMG vehicles)

Driver display:

➔ **Classic**

#### Selecting the center display content

The **Classic** menu shows the driver display separated into speedometer and tachometer. The area in between can be filled with various types of information.

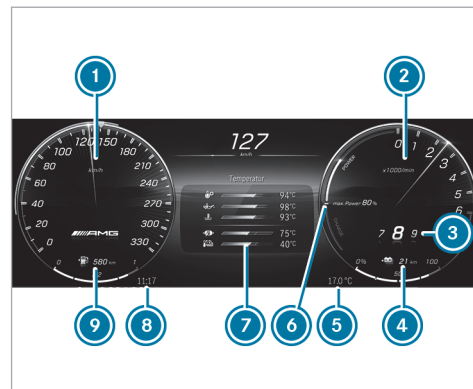

Illustration of plug-in hybrid vehicles (example)

- 1** Speedometer
- 2** Tachometer
- 3** Gear display
- 4** State of charge of the high-voltage battery
- 5** Outside temperature
- 6** Recuperation display and electric drive support display

- 7 Center display content (example: temperature)
  - 8 Time
  - 9 Fuel level and fuel filler flap location indicator
- ▶ Call up the **Classic** menu via the driver display menu bar.
- ▶ **To select display content:** swipe upwards or downwards on the left-hand Touch Control and select the display content.

The following information can be shown in the center display content:

- Trip and total distance
- Trip computer **From Start** and **From Reset**
- ECO display
- **Consumption**
- ATTENTION ASSIST
- **Audio**
- **Navigation**
- **Plug-in hybrid vehicles:** temperature (transmission oil, engine oil, coolant, high-voltage battery and high-voltage motor)

- **Vehicles with combustion engines:** temperature display (transmission oil, engine oil, coolant)
  - Set-up (drive, AMG DYNAMICS, suspension and sound)
  - Engine data (current power output and current torque)
- i Depending on the vehicle equipment, AMG-specific content regarding temperature, set-up and engine data will be displayed. You can set the display content either using the buttons on the multifunction steering wheel or via the MBUX multimedia system (→ page 20).

#### Changing the radio station or track on the station or track list

You can change radio stations or tracks on the station or track list in the center display content with audio information.

The following will be adjusted in the MBUX multimedia system:

- Configuring the station or track list
- Switching between media sources

- Setting the frequency band

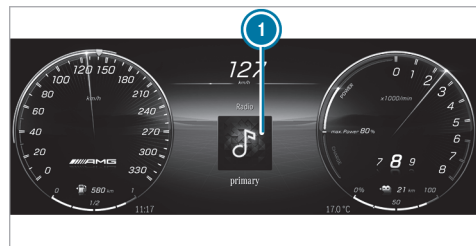

- i Radio stations in the center display content (example)

▶ **To change radio stations or tracks:** swipe left or right on the Touch Control and select a radio station or track on the station or track list.

- i If you do not select something immediately after opening the station or track list, the view will return to the radio station or track selected.

- ❗ The radio station or track displayed when the vehicle is restarted depends on the user profile used for the previous trip.

The following functions may be available on the **Options** submenu, for example:

- Navigation: selecting and adjusting zoom, route guidance and map settings
- Resetting the trip odometer
- Resetting the trip computer **From Start**
- Resetting the trip computer **From Reset**
- Resetting the ECO display values

### Changing color settings on the **Understated** menu

- ▶ Call up the **Understated** menu via the driver display menu bar.
- ▶ **To call up the color list:** press the Touch Control. The color list on the **Understated** menu will be displayed.

- ▶ **To select color settings:** swipe upwards or downwards on the left-hand Touch Control and change the color setting.

- ❗ If you do not select something immediately after opening the color list, the view will switch back to the default view for the **Understated** menu.

- ▶ **To exit the color list:** press the back button .

- ❗ Depending on the equipment, the selected color setting will also be adopted for the ambient lighting and the MBUX multimedia system. If you select the **Understated** menu on the driver display, the content in the MBUX multimedia system will also be made smaller.

### Service menu

Driver display:



The current status of the vehicle is shown on the **Service** menu.

- ▶ Press the main menu button  on the steering wheel.
- ▶ Swipe to the left or right on the Touch Control to select the **Service** menu on the menu bar of the driver display.
- ▶ **To call up the menu:** press the Touch Control.

The following display content is available on the **Service** menu (equipment-dependent):

- Information about how many messages are in the message memory
- **Tire Pressure:**
  - Checking the tire pressure with the tire pressure monitoring system
  - Restarting the tire pressure monitoring system
- **ASSYST PLUS:** calling up the service due date
- **Engine Oil Level:** checking the engine oil level
- **Plug-in hybrid vehicles:** temperature display (transmission oil, engine oil, coolant, high-voltage battery and high-voltage motor)

- **Vehicles with combustion engines:** temperature display (transmission oil, engine oil, coolant)

The following functions are available on the **Options** submenu:

- Tire pressure
- Message memory

## Supersport menu

Driver display:



### Selecting the center display content

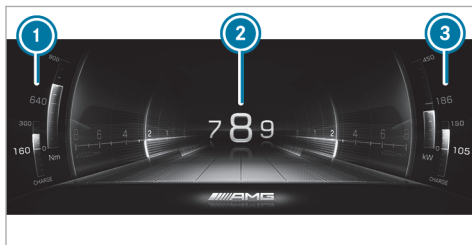

- 1 Current torque and recuperation display
- 2 Center display content (example: selected gear and electric drive support display)
- 3 Current power and recuperation display

▶ Press the main menu button  on the steering wheel.

▶ Swipe to the left or right on the Touch Control to call up the **Supersport** menu on the menu bar of the driver display.

▶ **To select display content:** swipe upwards or downwards on the Touch Control.

**i** Displays 1 and 3 vary depending on the center display content.

The center display content shows the following information:

- Transmission position display
- **Plug-in hybrid vehicles:** temperature display (transmission oil, engine oil, coolant, high-voltage battery and high-voltage motor)
- **Vehicles with combustion engines:** temperature display (transmission oil, engine oil, coolant)
- **Vehicles with combustion engines:** engine data
- Set-up (drive, AMG DYNAMICS, suspension and sound)
- G-force
- Trip and total distance

- Distance **From Start** and **From Reset**
- **Consumption**
- **Audio**
- **Navigation**

**i** Depending on the vehicle equipment, AMG-specific content regarding temperature, set-up and engine data will be displayed. You can configure the set-up display content either using the buttons on the multifunction steering wheel or via the MBUX multimedia system (→ page 20).

### Track Pace menu

Driver display:

→ **TRACK PACE**

The Track Pace function is intended only for closed race tracks. Do not use this function on public roads, and adapt your driving style to your personal capabilities and the ambient conditions.

The following options will be displayed on the **TRACK PACE** menu:

- G-meter

- Race track selected
- Braking and acceleration procedure
- Gear currently selected



Indicators on the Track Pace menu (example)

- ① G-meter
- ② Center display content (example: gear display)
- ③ Telemetry display (example: selected race track)

**▶ To call up the menu:** press the Touch Control.

The content of the **TRACK PACE** menu will adapt to the selected settings on the central display:

- Gear display

- Braking points
- Acceleration
- Quarter-miles
- Race track selected on the central display
- Current race
- Record route

While the vehicle is in motion, the G-meter will show the forces that are exerted on the vehicle occupants both laterally and in the direction of travel. The maximum values will be shown in red in the coordinate system.

### Overview of status indicators on the driver display (Mercedes-AMG vehicles)



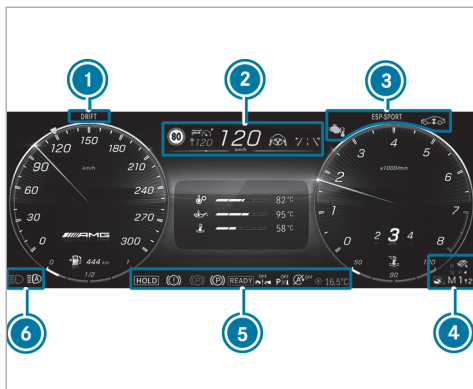













The status indicators for the driving and driving safety systems are shown in the ① and ⑥ areas.





**i** The number, position and presentation of the status indicators on the driver display depend on which systems are activated or deactivated.

Depending on the equipment, Mercedes-AMG vehicles have the following status displays:

 Pedestrian detection (on assistant display only)

-  Active Parking Assist is available
-  Active Parking Assist has detected a parking space
-  Parking Assist PARKTRONIC deactivated
-  Cruise control
-  Active Distance Assist DISTRONIC
-  Specified distance for Active Distance Assist DISTRONIC
-  Active Brake Assist switched off
-  Active Brake Assist impaired or not functioning
-  Active Steering Assist
-  Active Lane Change Assist
-  Active Lane Keeping Assist
-  Active Blind Spot Assist (on assistant display only)
-  Plug-in hybrid operation activated
-  Haptic accelerator pedal
-  ECO start/stop function
-  HOLD function
-  Adaptive Highbeam Assist

Adaptive Highbeam Assist Plus

-  Active Stop-and-Go Assist
-  Slippery road surface warning
-  Engine operating temperature warning lamp (→ page 12)

**Vehicles with Traffic Sign Assist:** detected instructions and traffic signs

Important information from other driving systems may briefly appear in front of the displayed traffic signs.

## AMG TRACK PACE

### Function of AMG TRACK PACE

- i** This function is an on-demand feature and can be activated via Mercedes me after you purchase your vehicle. The Digital Operator's Manual contains further information on Mercedes me and on-demand features.

With AMG TRACK PACE, the driving characteristics on race tracks can be analyzed and optimized. You can drive previously saved race tracks (e.g. the Hockenheimring), or record and save new tracks. The lap times set will be stored for every track. These can be analyzed and compared with other lap times to achieve the best possible race results. Additionally, acceleration and braking operations can be measured and stored.



**Note:** Use AMG TRACK PACE only on closed circuits away from public roads. Adapt your driving style to your personal skill level and environmental conditions. As the driver, you are solely responsible for driving your vehicle. Park your vehicle safely before operating the application.

### Setting Track Race



Multimedia system:

 TRACK PACE  Track Race

#### Recording a new track

-  Select **New Track**.
-  Select **Start Record** at the desired starting point.  
The track recording starts at this point.

During track recording, sectors can be set to divide up the track.

-  Select **Set Sector**.
-  Select **Stop Recording** to end track recording or cross the start line again.
- Confirm the prompt with **Yes**.
- Select the weather.



- i** The temperature will be determined automatically.
-  Enter a name.

-  Press **OK** to confirm.  
The track will be saved under the name entered.

#### Searching by track name

-  Select **Search**.
- Enter the track name.  
Tracks with the searched name are displayed.

#### Measuring time on a saved track



-  Select **All tracks**.
- Select the desired track.
- Select .
- Select **Start Time Recording** if you are already at the start line.

or

-  Select **Navigate to** to navigate to the start line.

Timekeeping begins automatically when the starting line has been crossed.





❗ When  is selected, the track display can be switched to AR. In addition, it is possible to switch to the telemetry display by selecting .

- ▶ Select  **Stop timekeeping** to end time-keeping.
- ▶ Confirm the prompt with **OK**.
- ▶ Select the weather.
- ▶ Select **Yes** to save the times set for this track.

### Showing readings during Track Race

The following readings can be shown:

- Tire temperature
  - Miniature map
  - Sector overview
  - Engine data
  - G-force display
  - Lap overview
- ▶ Select  **Start Time Recording**.
  - ▶ Select .

- ▶ Drag the desired display from the grid to the left or right edge of the central display. The readings will be shown during Track Race.

You can deactivate this by selecting  on the active display.

### Displaying the analysis

- ▶  Select **All tracks**. An overview of all the driven tracks appears.
- ▶ Select a track.
- ▶ Select a session.

The following data is displayed:

- Lap and sector times
  - average and maximum permissible speed
  - driver
  - Vehicle
  - Date
  - Weather
- ▶ Select **Add Recording** to use a different session as a reference value.
  - ▶ Select  to return to the overview.

- ▶ Select **Diagram**.
- ▶ Set the desired parameters. The analysis is displayed.

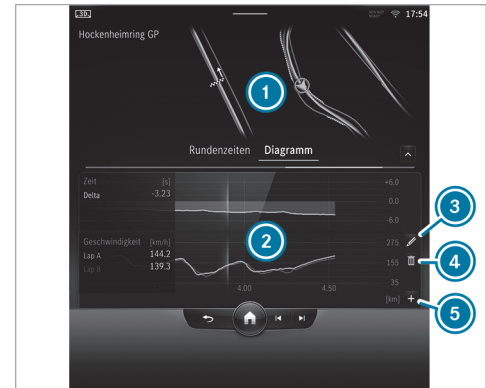



- ① Lap overview
- ② Parameter overview
- ③ Editing parameters
- ④ Deleting parameters
- ⑤ Adding new parameters

 The following values can be set for the parameters, for example:

- Speed
- longitudinal/lateral acceleration
- Steering angle
- engine speed
- engine oil/tire temperature

Based on the analysis, you can check and optimize driving characteristics for any position on the track.

### Exporting tracks (USB)

- ▶ Select  **Tracks** .  
An overview of all stored tracks will appear.
- ▶ Select the desired track.
- ▶ Select options  for the desired track.
- ▶ Select **Export Track to...**  
The selected track can be exported to a USB storage device connected to the vehicle.

### Editing tracks and recordings

- ▶ Select  **Tracks** .

- ▶ Select the desired track.
- ▶ Select options  for the desired track.
- ▶ Select **Rename** or **Delete**.

or

- ▶ Select a track.
- ▶ Highlight the desired recording.
- ▶ Select  Options.
- ▶ Select **Export to...** or **Delete**.

### Setting Drag Race

Multimedia system:

 **TRACK PACE**  **Drag Race**

### Measuring acceleration

- ▶ Select  **Drag race options**.
- ▶ Select **Acceleration**.
- ▶ Set a starting speed or select **Automatic**.  
Measurement will begin as soon as the specified starting speed has been reached.

- ▶ Set a target speed.  
Measurement will stop as soon as the specified target speed has been reached.
- ▶ Start off and begin the measurement.  
Measurement will begin when the vehicle accelerates.

You can stop measurement early by interrupting the acceleration procedure.

### Quarter-mile race

- ▶ Select  **Drag race options**.
- ▶ Select **Quarter Mile**.
- ▶ Set a target distance.  
Measurement will stop as soon as the specified target distance has been reached.
- ▶ Start off and begin the measurement.  
Measurement will begin when the vehicle accelerates. Timing will run until the target distance or a maximum of one mile has been traveled.

You can stop measurement early by interrupting the acceleration procedure.

### Measuring braking

- ▶  Drag Race options
- ▶ Select **Braking**.
- ▶ Set a starting speed or select **Automatic**.
- ▶ Start off and begin the measurement.
- ▶ Brake to a standstill.  
Measurement is incremental, in steps of 6 mph (10 km/h) to a standstill. If the braking procedure is started e.g. at a speed of 98 mph (157 km/h), measurement will start as soon as 93 mph (150 km/h) has been reached

### Storing and calling up measured values

If a measurement is completed or canceled, a prompt will appear asking whether the measurement should be saved.

- ▶ Confirm the prompt with **OK** to save.

### Calling up saved measurements

- ▶  Select **History**.
- ▶ Select **Acceleration**, **Quarter Mile** or **Braking**.

- ▶ Select a measurement.  
The desired measurement will be displayed in detail.
- or
- ▶ Delete a measurement.

### Calling up the telemetry display

Multimedia system:

↳ TRACK PACE ▶ Telemetry

The telemetry display shows current vehicle data as a digital value and as a diagram. Up to four parameters can be selected to be shown on the display.

For example:

- Engine speed
- Wheel angle
- Speed
- Steering angle
- ▶ Set the desired parameters.

- ▶ Set the time.  
The set parameters will be evaluated for the selected time on the diagram.

### Configuring AMG TRACK PACE

#### Requirements

To connect a mobile device to the TRACK PACE app:

- the TRACK PACE app is installed on the mobile end device.
- the mobile end device is connected to the multimedia system via Wi-Fi.

Multimedia system:

↳ TRACK PACE ▶ 

#### Connecting a mobile device via the TRACK PACE app

The TRACK PACE app makes it possible to record videos and to synchronize them with stored tracks.

- ▶ Select **TRACK PACE App**.
- ▶ Select **Authorize a New Device**.

- ▶ Start the TRACK PACE app on the device to be connected.
- ▶ Select **Continue** and confirm the authorization prompt. A four-digit code will be shown on the central display.
- ▶ Enter the code on your smartphone. The device is authorized.

#### De-authorizing the mobile device

- ▶ Select **TRACK PACE App**.
- ▶ Select a device.
- ▶ Confirm the message prompt with Yes. The device is de-authorized.

#### Setting the TRACK PACE display on the head-up display and driver's display

- ▶ Select **IC and HUD Contents**.
  - ▶ Activate or deactivate the desired contents. The content on the head-up display and the driver's display will be adapted.
- i** Further information about the head-up display .

- i** Further information about the driver's display .

#### Setting acoustic feedback

- ▶ Select **Acoustic Feedback**. A scale with values from 0 to 10 is shown.
- ▶ Select a setting.

#### Displaying statistics

- ▶ Select **TRACK PACE Statistics**. Statistics on the current user profile will be displayed. The following data is displayed:
  - Driving time
  - track driven
  - tracks recorded
  - Track Races recorded
  - laps recorded
  - Drag Races recorded
  - maximum design speed

#### Activating the ambient light

If this function is active, the vehicle interior is lit red or green depending on Delta Time.

- ▶ Select **Ambient Light**.
- ▶ Activate or deactivate the function.

#### Adjusting the dashcam

If the vehicle is equipped with a dashcam, it can be used in AMG TRACK PACE.

- ▶ Select **Dashcam**.
- ▶ Select **Track Race** or **Drag Race** and apply **Activate Recording**.
- ▶ You can set which overlay is to be used in the recorded video under **Video Overlay Content**.

#### Activating boost strategy

This function is used to increase performance on a race track and is available only in the  drive program.

- ▶ Select **boost strategy**.
  - ▶ Activate or deactivate the function.
- i** The function is not available for all vehicle models.

### Notes on the care of tailpipes

**⚠ WARNING** Risk of burns from the tailpipe and tailpipe trims

The exhaust tailpipe and tailpipe trims can become very hot. If you come into contact with these parts of the vehicle, you could burn yourself.

- ▶ Always be particularly careful around the tailpipe and the tailpipe trims and supervise children especially closely in this area.
- ▶ Allow vehicle parts to cool down before touching them.

Observe the following notes in order to prevent damage to the vehicle:

- Clean the tailpipes with a cleaning agent recommended for Mercedes-Benz, especially in the winter and after washing the vehicle.
- Do not use acidic cleaning agents.

### Removing the warning triangle

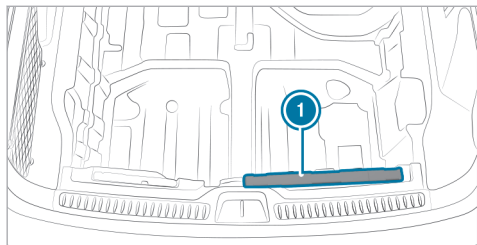

Warning triangle ① is located under the cargo floor in the loading sill when the vehicle is delivered.

- ▶ Remove warning triangle ①.

### Notes on starting assistance

Observe the information on starting assistance in the vehicle Operator's Manual.

If your vehicle has been started with starting assistance, it may not be possible to use the electric drive for approximately 30 minutes.

Starting assistance is not considered to be a normal operating condition.

Jumper cables and further information regarding starting assistance can be obtained at any qualified specialist workshop.

### Permissible towing methods (Mercedes-AMG E Performance)

#### ! NOTE Damage caused by towing

Towing can damage the hybrid system.

- ▶ Have the vehicle loaded and transported rather than towed.

### Changing a wheel

- ▶ Be sure to also observe the notes on changing a wheel in the Operator's Manual of your vehicle.

#### Vehicles with AMG Driver's Package:

**⚠ WARNING** Risk of accident caused by non-approved tire types

If you use tire types that have not been adapted to changes made to the factory speed limit, this can have the following consequences:

- The tires are not suitable for high speeds and the corresponding driving dynamics.
- The tires wear unevenly and affect the roadworthiness of the vehicle.
- ABS, ESP® and cruise control operation are restricted.

This can jeopardize road safety.

- ▶ Only use tire types that have been approved for the maximum permissible speed set and the vehicle.

#### Vehicles with AMG ceramic high-performance composite braking system:

**⚠ NOTE** Damage to the ceramic brake disc when changing a wheel

**Mercedes-AMG vehicles with ceramic brake discs:** during removal and repositioning of the wheel, the wheel rim can strike the ceramic-brake disc and damage it.

- ▶ Take particular care.
- ▶ Ask another person for assistance or use a second alignment bolt.

- ▶ When changing the wheel, avoid exerting any force on the brake disks. This can lead to impaired comfort during braking.

### Collapsible spare wheel

#### Deflate and store collapsible spare wheel

##### Requirements

The collapsible spare wheel is removed.

##### Deflate collapsible spare wheel

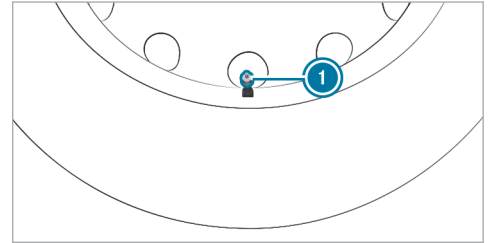

- ▶ Remove valve cap ①.

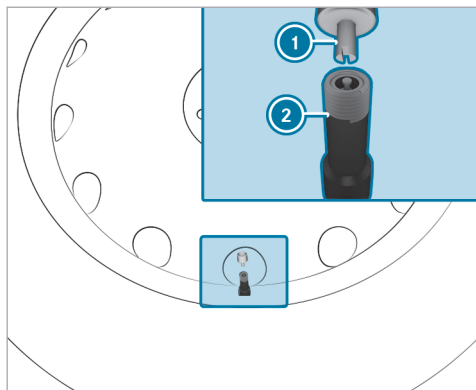

- ▶ Insert valve cap ① into the valve with the opposite side ②.
- ▶ Remove the valve from the collapsible spare wheel by rotating to the left and let the air out until the collapsible spare wheel is completely deflated.

**i** In doing so, observe that the valve does not come out due to the air pressure of the collapsible spare wheel.

### Store collapsible spare wheel

- ▶ Fold tire and store collapsible spare wheel in the emergency spare wheel bag.
- ▶ With the aid of the valve cap, screw the valve back into the collapsible spare wheel by rotating it to the right.
- ▶ Screw the valve cap onto the valve.
- ▶ Close emergency spare wheel bag.

### Secure the collapsible spare wheel bag Emergency spare wheel bag with two straps

- ▶ Secure the emergency spare wheel bag in the load compartment using the two rear tie-down eyes.

### Emergency spare wheel bag with four straps

- ▶ Secure the emergency spare wheel bag in the load compartment using the front and two rear tie-down eyes.



## Operating fluids

### Fuel

#### Information on fuel quality for Mercedes-AMG vehicles

Observe the notes on operating fluids in the Operator's Manual for the vehicle.

**!** **NOTE** Damage caused by the wrong type of fuel

Even small amounts of the wrong type of fuel can result in damage to the fuel system, the engine and the emission control system.

▶ Refuel only with low-sulfur gasoline.

This fuel may contain up to 10 %- ethanol by volume. Your vehicle is suitable for use with E10- fuel.

Never refuel with any of the following fuels:

- Diesel
- Gasoline with more than 10 %- ethanol by volume, e.g. E15, E85, E100

- Gasoline with more than 3% methanol by volume-, e.g. M15, M30, M85, M100
- Gasoline with metallic additives

If you accidentally did fill up with the wrong fuel:

- ▶ Do not start the vehicle.
- ▶ Consult a qualified specialist workshop.

If the available fuel is not sufficiently low in sulfur, it may produce unpleasant odors.

Refuel only with premium-grade unleaded gasoline that has an octane number of at least 91 AKI/ 95 RON.

As a temporary measure, if the recommended fuel is not available, you may also use regular unleaded gasoline. When doing this, note the octane number on the information label inside the fuel filler flap (see the vehicle Operator's Manual). Filling up with regular unleaded gasoline may reduce engine output and increase fuel consumption.

Never refuel using gasoline with an even lower RON.

**!** **NOTE** Premature engine wear through unleaded regular gasoline

Impairment of the longevity and performance of the engine.

If unleaded premium grade gasoline is unavailable and you have to refuel using unleaded regular gasoline:

- ▶ Only fill the fuel tank to half full with unleaded regular gasoline and refill as soon as possible with unleaded premium grade gasoline.
- ▶ Do not drive at the maximum design speed.
- ▶ Avoid sudden acceleration and engine speeds over 3000 rpm.

Further information on fuel is available in the following locations:

- At a gas station
- At a qualified specialist workshop
- **USA only:** on the <https://www.mbusa.com>

### Tank content and fuel reserve (Mercedes-AMG vehicles)

The total capacity of the fuel tank may vary depending on the vehicle equipment.

**Not for Mercedes-AMG E PERFORMANCE:**

#### Total fuel tank capacity

Model	
Mercedes-AMG GLC 43 4MATIC	16.4 gal (62.0 liters)

#### Fuel tank reserve

Model	
Mercedes-AMG GLC 43 4MATIC	2.6 gal (10.0 liters)

**Mercedes-AMG E PERFORMANCE:**

### Total fuel tank capacity (Mercedes-AMG E PERFORMANCE)

Model	
Mercedes-AMG GLC 63 S E PERFORMANCE	17.2 gal (65.0 liters)

### Fuel tank reserve (Mercedes-AMG E PERFORMANCE)

Model	
Mercedes-AMG GLC 63 S E PERFORMANCE	2.6 gal (10.0 liters)

### Engine oil quality and filling quantity (Mercedes-AMG vehicles)

**Not for Mercedes-AMG E PERFORMANCE:**

### Engine oil specification

Model	MB-Freigabe or MB-Approval
Mercedes-AMG GLC 43 4MATIC	229.71

**Mercedes-AMG E PERFORMANCE:**

### Engine oil specification (Mercedes-AMG E PERFORMANCE)

Model	MB-Freigabe or MB-Approval
Mercedes-AMG GLC 63 S E PERFORMANCE	229.71

Use only engine oils of viscosity class SAE 0W-20.

To achieve the lowest possible fuel consumption, it is recommended to use the engine oil specifications marked in the table with the lowest SAE viscosity class in each case. Observe possible restrictions of the approved SAE viscosity classes.

**Not for Mercedes-AMG E PERFORMANCE:**

**Engine oil filling quantity**

Model	Quantity
Mercedes-AMG GLC 43 4MATIC	6.3 US qt (6.0 liters)

**Mercedes-AMG E PERFORMANCE:**
**Engine oil filling quantity (Mercedes-AMG E PERFORMANCE)**

Model	Quantity
Mercedes-AMG GLC 63 S E PERFORMANCE	6.3 US qt (6.0 liters)

The specified filling quantity refers to an oil change with the oil filter.

[Coolant filling quantity \(Mercedes-AMG vehicles\)](#)

Not for Mercedes-AMG E Performance:

**Coolant**

Model	Quantity
Mercedes-AMG GLC 43 4MATIC	13.1 US qt (12.4 liters )

**Mercedes-AMG E PERFORMANCE:**

Missing values were not available by the editorial deadline.

**Coolant (Mercedes-AMG E PERFORMANCE)**

Model	Quantity
Mercedes-AMG GLC 63 S E PERFORMANCE	

[Filling quantity for refrigerant and PAG oil \(Mercedes-AMG vehicles\)](#)

Missing values were not available by the editorial deadline.

**Refrigerant filling capacity**

Model	Quantity
Mercedes-AMG GLC 43 4MATIC	

**Filling quantity for PAG oil**

Model	Quantity
Mercedes-AMG GLC 43 4MATIC	

**Mercedes-AMG E PERFORMANCE:**
**Refrigerant filling quantity (Mercedes-AMG E PERFORMANCE)**

Model	Quantity
Mercedes-AMG GLC 63 S E PERFORMANCE	

**PAG oil filling quantity (Mercedes-AMG E PERFORMANCE)**

Model	
Mercedes-AMG GLC 63 S E PERFORMANCE	

**Vehicle data****Vehicle dimensions (Mercedes-AMG vehicles)**

The heights specified may vary as a result of the following factors:

- Tires
- Load
- Condition of the suspension
- Special equipment

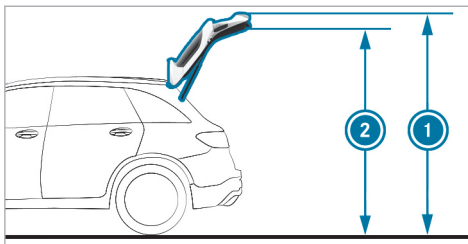

- ① Height when open
- ② Standing headroom

**Not for Mercedes-AMG E PERFORMANCE:**

**Height when open and standing headroom**

Model	① Height when open	② Standing headroom
Mercedes-AMG GLC 43 4MATIC	84.4 in (2145 mm)	76.9 in (1954 mm)

**Vehicle dimensions**

Mercedes-AMG GLC 43 4MATIC	
Vehicle length	187.0 in (4749 mm)
Vehicle width including exterior mirrors	81.7 in (2076 mm)
Vehicle height	64.4 in (1635 mm)
Wheelbase	113.7 in (2888 mm)
Turning radius	42.3 ft (12.9 m)
Maximum ground clearance	6.2 in (157 mm)
Minimum ground clearance	5.9 in (151 mm)

**Mercedes-AMG E PERFORMANCE:**

**Height when open and headroom (Mercedes-AMG E PERFORMANCE)**

Model	① Height when open	② Standing headroom
Mercedes-AMG GLC 63 S E PERFORMANCE	84.3 in (2141 mm)	76.8 in (1951 mm)

**Vehicle dimensions (Mercedes-AMG E PERFORMANCE)**

Mercedes-AMG GLC 63 S E PERFORMANCE	
Vehicle length	187.0 in (4749 mm)
Vehicle width including exterior mirrors	81.7 in (2076 mm)
Vehicle height	64.4 in (1635 mm)
Wheelbase	113.7 in (2888 mm)
Turning radius	42.3 ft (12.9 m)

**Mercedes-AMG GLC 63 S E PERFORMANCE**

Maximum ground clearance	5.7 in (144 mm)
Minimum ground clearance	5.6 in (143 mm)

**Weights and loads (Mercedes-AMG vehicles)**

Bear in mind that items of special equipment increase the curb weight and reduce the payload. Vehicle-specific weight information can be found on the vehicle identification plate.

**Off-road driving (Mercedes-AMG models)**

Also observe the notes on off-road driving, mountains and water courses in the Operator's Manual.

**Fording**

**!** NOTE Damage caused by water when fording

Water can enter the engine compartment and vehicle interior in the following cases:

- The maximum permissible fording depth is exceeded when traveling through standing water.
  - A bow wave forms during fording.
  - Water accumulates when fording.
- ▶ Do not exceed the maximum permissible fording depth.
- ▶ Drive slowly through water.
- ▶ When driving through flowing water, be aware that the permissible fording depth is lower due to the accumulation of water.

The specified value indicates the maximum permissible fording depth for vehicles that are ready to drive and for slow driving through standing water.

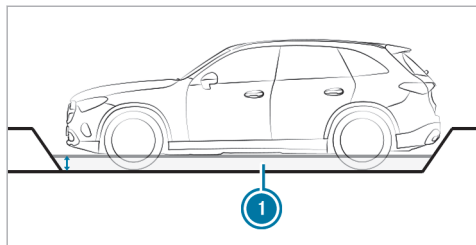

Not for Mercedes-AMG E PERFORMANCE:

#### Fording depth

Model	1 Fording depth
Mercedes-AMG GLC 43 4MATIC	9.8 in (25 cm)

Mercedes-AMG E PERFORMANCE:

#### Fording depth

Model	1 Fording depth
Mercedes-AMG GLC 63 S E PERFORMANCE	9.8 in (25 cm)

#### Notes on the angle of approach/departure

The specified values are maximum values for vehicles that are ready to drive.

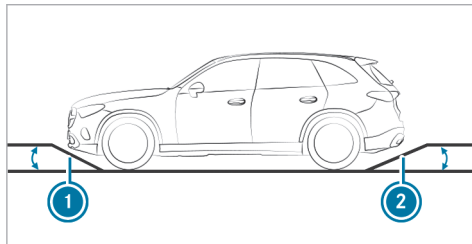

Not for Mercedes-AMG E PERFORMANCE:

#### Angle of approach/departure

Model	1 Front	2 Rear
Mercedes-AMG GLC 43 4MATIC	14.2°	18.5°

Mercedes-AMG E PERFORMANCE:

#### Angle of approach/departure (Mercedes-AMG E PERFORMANCE)

Model	1 Front	2 Rear
Mercedes-AMG GLC 63 S E PERFORMANCE	14.5°	18.4°

#### Maximum gradeability

The vehicle's gradeability depends on the weight distribution in the vehicle, the terrain conditions and the road surface conditions.

The specified value applies when:

- the vehicle is ready to drive.

- the road surface conditions and thus the traction are good.

A gradeability of 100 % corresponds to an incline of 45°.

Observe the notes on driving in mountainous terrain in the Operator's Manual.

Missing values were not available at the time of going to press.

**Not for Mercedes-AMG E PERFORMANCE:**

#### Gradeability

Model	Maximum gradeability
Mercedes-AMG GLC 43 4MATIC	

**Mercedes-AMG E PERFORMANCE:**

#### Gradeability

Model	Maximum gradeability
Mercedes-AMG GLC 63 S E PERFORMANCE	

#### High-voltage battery (Mercedes-AMG E PERFORMANCE)

Information on the all-electric range can be found in the driver display (see section "Function of the condition of charge display in the driver display" in the Operator's Manual).

Missing values were not available by the editorial deadline.

#### Energy content and charging times

Mercedes-AMG GLC 63 S E PERFORMANCE	
Type	Lithium-ion
Maximum energy content	6.1 kWh
Range in all-electric mode	
Charging time – mode 2	The charging capacity was not available by the editorial deadline.

– Mode 2 charging time applies to AC charging from 25 % to 100 % of the usable energy content.

The time taken to charge the battery depends on the state of charge of the battery, the ambient temperature and the charging capacity of the battery. The charging power, in turn, depends on the

supply voltage, the current and the type of power supply.

The nominal voltage range for your vehicle can be found on the information label in the socket flap.

### Trailer hitch

#### General notes on the trailer hitch

Modifications to the cooling system may be necessary, depending on the vehicle model. The retrofitting of a trailer hitch is permissible only if a towing capacity is specified in your vehicle documents.

Further information can be obtained at a qualified specialist workshop.

Observe the information and notes on the trailer hitch in the chapter "Driving and parking" in the Operator's Manual.

#### Trailer load (Mercedes-AMG vehicles)

- i** The tongue weight is not included in the trailer load.

The values for the **trailer load, braked** apply with a minimum start-off gradeability of 12 %.

Missing values were not available by the editorial deadline.

#### Not for Mercedes-AMG E PERFORMANCE:

##### Trailer load, braked

Model	
Mercedes-AMG GLC 43 4MATIC	

##### Trailer load, unbraked

Model	
Mercedes-AMG GLC 43 4MATIC	

#### Mercedes-AMG E PERFORMANCE:

##### Trailer load, braked (Mercedes-AMG E PERFORMANCE)

Model	
Mercedes-AMG GLC 63 S E PERFORMANCE	

##### Trailer load, unbraked (Mercedes-AMG E PERFORMANCE)

Model	
Mercedes-AMG GLC 63 S E PERFORMANCE	

#### Maximum tongue-weight and load capacity (Mercedes-AMG vehicles)

**!** **NOTE** Damage caused by the trailer coming loose

If the tongue weight used is too low, the trailer may come loose.



- ▶ The tongue weight must not be below 110.2 lbs (50 kg).
- ▶ Use a tongue weight that is as close as possible to the maximum permissible tongue weight.

**!** **NOTE** Damage caused by the bicycle rack coming loose

When using a bicycle rack, both the maximal tongue weight and the maximal load capacity should be observed.

- ▶ Do not exceed the permissible load capacity.

Observe the additional notes on load capacity in the vehicle Operator's Manual.

Missing values were not available by the editorial deadline.

**Not for Mercedes-AMG E PERFORMANCE:**

**Tongue weight**

Model	Maximum tongue weight
Mercedes-AMG GLC 43 4MATIC	

**Load capacity**

Model	Maximum load capacity
Mercedes-AMG GLC 43 4MATIC	

**Mercedes-AMG E PERFORMANCE:**

**Tongue weight (Mercedes-AMG E PERFORMANCE)**

Model	Maximum tongue weight
Mercedes-AMG GLC 63 S E PERFORMANCE	

**Load capacity (Mercedes-AMG E PERFORMANCE)**

Model	Maximum load capacity
Mercedes-AMG GLC 63 S E PERFORMANCE	

**Gross axle weight rating, rear axle (Mercedes-AMG vehicles)**

Missing values were not available by the editorial deadline.

**Not for Mercedes-AMG E PERFORMANCE:**

**Trailer operation axle load**

Model	Axle load
Mercedes-AMG GLC 43 4MATIC	

**Mercedes-AMG E PERFORMANCE:**

**Axle load in trailer operation (Mercedes-AMG E PERFORMANCE)**

Model	Axle load
Mercedes-AMG GLC 63 S E PERFORMANCE	

## Display messages

### Vehicle

Display messages	Possible causes/consequences and ► Solutions
Electronic Rear Axle Differential Lock Inoperative	<ul style="list-style-type: none"> <li>* The electronic locking differential has failed.               <ul style="list-style-type: none"> <li>► Consult a qualified specialist workshop.</li> </ul> </li> </ul>
Electronic Rear Axle Differential Lock Currently Unavailable	<ul style="list-style-type: none"> <li>* The electronic locking differential is overheated.               <ul style="list-style-type: none"> <li>► Let the electronic locking differential cool down by driving defensively.</li> </ul> </li> </ul>

### Driving and driving safety systems

Display messages	Possible causes/consequences and ► Solutions
RACE START Canceled	<ul style="list-style-type: none"> <li>* Possible causes:               <ul style="list-style-type: none"> <li>• you released the accelerator pedal during RACE START.</li> <li>• you depressed the brake pedal during RACE START.</li> </ul> </li> <li>► You can try RACE START again at the next start.</li> </ul>
RACE START Not Possible See Operator's Manual	<ul style="list-style-type: none"> <li>* Possible causes are:               <ul style="list-style-type: none"> <li>• The activation conditions have not been fulfilled (→ page 26).</li> </ul> </li> </ul>

Display messages	Possible causes/consequences and ► Solutions
<p>AMG Ride Control Function Limited See Operator's Manual</p>	<p>* At least one of the main functions of AMG RIDE CONTROL is malfunctioning. At least one of the main functions of AMG ACTIVE RIDE CONTROL is malfunctioning. The system is outside the operating temperature range or the on-board electrical system voltage is too low. Once the cause of the problem is no longer present, the system will be available again.</p> <div style="border: 1px solid black; padding: 5px; margin: 10px 0;"> <p><b>!</b> <b>NOTE</b> The vehicle's suspension and damping behavior is restricted. The vehicle body may tilt heavily to the side during cornering.</p> <ul style="list-style-type: none"> <li>► Drive on carefully.</li> <li>► Reduce speed considerably before taking a bend.</li> <li>► Avoid sudden steering movements.</li> </ul> </div> <ul style="list-style-type: none"> <li>► Drive on carefully.</li> <li>► Reduce speed considerably before taking a bend.</li> <li>► Avoid sudden steering movements.</li> </ul>
<div style="border: 1px solid black; width: 40px; height: 40px; margin: 0 auto; text-align: center; line-height: 40px;">  </div> <p>Malfunction Do Not Exceed 50 mph</p>	<p>* AMG RIDE CONTROL is malfunctioning. The vehicle's handling characteristics may be affected. AMG ACTIVE RIDE CONTROL is malfunctioning. The vehicle's handling characteristics may be affected.</p> <ul style="list-style-type: none"> <li>► Do not drive at speeds greater than 50 mph (80 km/h).</li> <li>► Consult a qualified specialist workshop.</li> </ul>



## Warning and indicator lamps

## Engine

Warning/indicator lamp	Possible causes/consequences and ► Solutions
 <p data-bbox="195 467 462 515">Engine operating temperature warning lamp</p>	<p data-bbox="519 373 1689 422">*The blue warning lamp for engine operating temperature will remain lit until the engine operating temperature has been reached. The engine output and engine torque will remain reduced until then.</p> <p data-bbox="528 459 1031 484">► Take this into consideration in your driving style.</p>

## Driving and driving safety systems

Warning/indicator lamp	Possible causes/consequences and ► Solutions
 <p data-bbox="195 754 447 802">Suspension warning lamp (yellow)</p>	<p data-bbox="510 660 1031 709">* The yellow AMG RIDE CONTROL warning lamp is lit. There is a malfunction in the AMG RIDE CONTROL.</p> <p data-bbox="528 721 957 745">► Note the messages on the driver display.</p>

Warning/indicator lamp	Possible causes/consequences and ► Solutions
 <p data-bbox="144 342 397 394">Suspension warning lamp (yellow)</p>	<p data-bbox="458 249 1060 298">* The yellow AMG ACTIVE RIDE CONTROL warning lamp is lit. There is a malfunction in the AMG ACTIVE RIDE CONTROL.</p> <ul data-bbox="476 308 907 335" style="list-style-type: none"><li>► Note the messages on the driver display.</li></ul>
	<p data-bbox="458 410 1197 500">* The yellow ESP® OFF warning lamps are lit while the vehicle is running. ESP® is deactivated. Other driving systems and driving safety systems may also be inoperative.</p> <div data-bbox="482 515 1644 764"><p data-bbox="495 526 1153 553"><b>▲ WARNING</b> Risk of skidding when driving with ESP® deactivated</p><p data-bbox="495 567 1517 594">ESP® does not act to stabilize the vehicle. The availability of further driving safety systems is also limited.</p><ul data-bbox="495 605 1097 667" style="list-style-type: none"><li>► Drive on carefully.</li><li>► Deactivate ESP® only for as long as the situation requires.</li></ul><p data-bbox="495 692 1009 718">If ESP® cannot be activated, ESP® is malfunctioning.</p><ul data-bbox="495 729 1184 756" style="list-style-type: none"><li>► Have ESP® checked immediately at a qualified specialist workshop.</li></ul></div> <p data-bbox="476 781 1045 808">► Observe the notes on deactivating ESP® (→ page 22).</p>

Warning/indicator lamp	Possible causes/consequences and ► Solutions
 <p>The icon shows a car with a wavy line underneath it, indicating a loss of control or skidding. Below the car, the word 'OFF' is written. The entire icon is enclosed in a rectangular box with the text 'ESP SPORT' written below it.</p>	<p>* ESP<sup>®</sup> SPORT is activated while the vehicle is running. When ESP<sup>®</sup> SPORT is activated, ESP<sup>®</sup> will stabilize the vehicle only to a limited extent.</p> <p><b>▲ WARNING</b> Risk of skidding if ESP<sup>®</sup> SPORT is used incorrectly</p> <p>When you activate ESP<sup>®</sup> SPORT, there is an increased risk of skidding and having an accident.</p> <ul style="list-style-type: none"><li>► Activate ESP<sup>®</sup> SPORT only in the circumstances described below.</li></ul> <p>► Observe the notes on activating ESP<sup>®</sup> SPORT(→ page 22).</p>



<b>A</b>			
Acoustic presence indicator.....	12	Function.....	38
Acoustic Vehicle Indication.....	12	Telemetry display.....	41
AMG ACTIVE RIDE CONTROL		Track Race.....	38
Function.....	29	<b>Angle of approach/departure.....</b>	<b>51</b>
AMG adaptive sport suspension system		<b>Authorized Mercedes-Benz Service Center.....</b>	<b>8</b>
Suspension.....	28	<b>Authorized workshop.....</b>	<b>8</b>
AMG ceramic high-performance composite brake system.....	16	<b>Automatic transmission</b>	
AMG DYNAMIC SELECT		Drive programs.....	16
Setting drive programs.....	20	DYNAMIC SELECT button.....	16
AMG Real Performance Sound.....	15	Manual gear shifting.....	21
AMG RIDE CONTROL		Steering wheel paddle shifters.....	21
Selecting the suspension setting.....	28	<b>AVAS, Acoustic vehicle alerting system.....</b>	<b>12</b>
AMG steering wheel buttons		<b>Axle load</b>	
Setting.....	13	Towing a trailer.....	55
AMG steering-wheel buttons			
Function.....	13	<b>B</b>	
AMG TRACK PACE		<b>Battery (high-voltage on-board electrical system).....</b>	<b>53</b>
Boost Strategy.....	27	<b>Battery operation.....</b>	<b>12</b>
Configuring.....	41	<b>Bicycle rack</b>	
Drag Race.....	40	Load capacity.....	54
		<b>Boost Strategy</b>	
		Activating/deactivating (steering-wheel button).....	27
		Function.....	27
		<b>Brakes</b>	
		AMG ceramic high-performance composite brake system.....	16
		<b>C</b>	
		<b>Care</b>	
		Tailpipes.....	43
		<b>Charging</b>	
		Notes on charging the high-voltage battery.....	12
		<b>Classic menu display content</b>	
		Selecting.....	32
		<b>Climate control</b>	
		Filling capacity for refrigerant and PAG oil.....	49
		Pre-entry climate control when the vehicle is unlocked.....	10
		<b>Cockpit</b>	
		Instrument panel.....	4



- Coolant**  
Capacity..... 49
- D**
- Dealership**..... 8
- DIRECT SELECT lever**  
Manual gearshifting..... 21
- Display (driver's display)**  
Overview of displays..... 36
- Display messages**  
 Malfunction Do Not Exceed 50 mph..... 58  
AMG Ride Control Function Limited  
See Operator's Manual..... 58  
Electronic Rear Axle Differential Lock  
Currently Unavailable..... 57  
Electronic Rear Axle Differential  
Lock Inoperative..... 57  
RACE START Canceled..... 57  
RACE START Not Possible See Operator's Manual..... 57
- Drag Race**..... 40
- Drive program display**..... 18
- Drive programs**  
AMG DYNAMIC SELECT..... 20  
Selecting..... 18
- Driver display, Instrument cluster**  
Function/notes..... 30  
Service menu..... 34  
Track Pace menu..... 36
- Driver's display**  
Classic menu..... 32  
Operating..... 31  
Status displays..... 36  
Supersport menu..... 35  
Understated menu..... 32
- Driving safety system**  
ESP® (Electronic Stability Program)..... 22
- Driving tips**  
Acoustic presence indicator (sound generator)..... 12  
AMG ceramic high-performance composite brake system..... 16
- DYNAMIC SELECT**  
Configuring drive program I..... 19  
Drive program display..... 18  
Drive programs..... 16  
Function..... 16  
Selecting the drive program..... 18
- E**
- E10**..... 47
- E25**..... 47
- ECO start/stop button**  
Automatic engine start/stop..... 14
- ECO start/stop function**  
Switching off/on..... 14
- Electric drive**..... 12
- Electronic Stability Program**..... 22
- Engine oil**  
Capacity..... 48  
MB-Freigabe or MB-Approval..... 48  
Quality..... 48
- Engine operating temperature**  
Warning lamp..... 12
- Engine output**..... 12



Operator's manual.....	6	Activation conditions.....	26	<b>Shifting</b>	
<b>P</b>		Information.....	26	Automatic transmission.....	21
<b>Paddle shifters</b>		<b>Racetrack mode</b>		Manual.....	21
Steering wheel paddle shifters.....	21	AMG ceramic high-performance com- posite brake system.....	16	Steering wheel paddle shifters.....	21
<b>Permitted towing methods</b>		AMG steering-wheel buttons.....	13	<b>Sound</b>	
Overview.....	44	<b>Recuperation</b>		AMG Real Performance Sound.....	15
<b>Plug-in hybrid operation</b>		Setting.....	14	<b>Sound generator</b> .....	12
Notes on plug-in hybrid operation.....	12	<b>Reserve</b>		<b>Specialist workshop</b> .....	8
Sets recuperation.....	14	Fuel.....	48	<b>Starting assistance</b> .....	44
<b>Pre-entry climate control</b>		<b>Restraint system</b>		<b>Steering wheel paddle shifters</b> .....	21
When vehicle is unlocked.....	10	Malfunction.....	9	<b>Stop and go</b>	
<b>Pre-heating</b> .....	10	<b>Rocking free</b> .....	20	ECO start/stop function.....	14
<b>Programs</b> .....	16	<b>S</b>		<b>Sulfur content</b> .....	47
<b>Protection of the environment</b>		<b>Seat belts</b>		<b>Supersport menu display content</b>	
Driving style.....	6	Reduced protection.....	9	Selecting.....	35
<b>Q</b>		<b>Selecting a gear</b> .....	21	<b>Suspension</b>	
<b>Qualified specialist workshop</b> .....	8	<b>Selecting a sound characteristic (steering- wheel button)</b> .....	15	AMG ACTIVE RIDE CONTROL.....	29
<b>R</b>		<b>Service</b>		AMG adaptive sport suspension system... Selecting the suspension setting.....	28
<b>RACE START</b>		Menu (driver display).....	34	<b>T</b>	
Activating.....	26	<b>Service center</b> .....	8	<b>Tailpipes</b>	
				Care.....	43

- Tank capacity**  
 Fuel..... 48  
 Reserve..... 48
- Technical data**  
 Axle load (trailer operation)..... 55  
 High-voltage battery..... 53  
 Tongue weight..... 54  
 Towing capacity..... 54  
 Vehicle dimensions..... 50
- Telemetry display**..... 41
- Tires**  
 Installing..... 45
- Tongue weight**..... 54
- Touch Control**  
 Driver's display..... 31
- Towing**  
 Towing methods..... 44
- Towing a trailer**  
 Axle load..... 55
- Towing methods**  
 Overview..... 44
- Track Pace**  
 Menu (driver display)..... 36
- Track Race**..... 38
- Trailer hitch**  
 Axle load..... 55  
 General notes..... 54  
 Tongue weight..... 54  
 Towing capacity..... 54
- U**
- Understated menu display content**  
 Selecting..... 32
- V**
- Vehicle**  
 Equipment..... 6  
 Medical aids..... 8  
 Rocking free..... 20  
 Towing away..... 44
- Vehicle data**  
 Angle of approach/departure..... 51  
 Fording water..... 51  
 Turning circle..... 50  
 Vehicle height..... 50  
 Vehicle length..... 50  
 Vehicle width..... 50
- Weights..... 51  
 Wheelbase..... 50
- Vehicle dimensions**..... 50
- Vehicle equipment**..... 6
- W**
- Warning triangle**..... 44
- Warning/indicator lamp**  
 Engine operating temperature  
 warning lamp..... 59  
 Suspension warning lamp (yellow)  
 low)..... 59, 60
- Wheel change**  
 Installing a new wheel..... 45
- Wheels**  
 Installing..... 45
- Workshop**..... 8

