



Order no. 6522 0241 13
Part no. 453 584 29 10
Edition C-2017

smart fortwo coupe and smart fortwo cabrio electric drive Operator's Manual



>> Operator's Manual

smart fortwo coupe and smart fortwo cabrio electric drive

Symbols in the Operator's Manual

Registered trademarks:

- Android™ is a registered trademark of Google, Inc.
- Apple® iOS and iPod® are registered trademarks of Apple, Inc.
- Bass boost arkamys® is a registered trademark of Arkamys.
- Bluetooth® is a registered trademark of Bluetooth SIG Inc.
- ESP® is a registered trademark of Daimler AG.
- IQ Routes™ is a registered trademark of TomTom International B.V.
- MirrorLink™ is a registered trademark of the Car Connectivity Consortium.

The following symbols are used in this Operator's Manual:

WARNING

Warning notes make you aware of dangers which could pose a threat to your health or life, or to the health and life of others.

Environmental note

Environmental notes provide you with information on environmentally aware actions or disposal.

 Notes on material damage alert you to dangers that could lead to damage to your vehicle.

 Practical tips or further information that could be helpful to you.

► Instructions that must be followed.

► Several consecutive symbols indicate an instruction with several consecutive steps.

(▷ page) Further information on a topic

▷▷ A warning or an instruction that is continued on the next page.

Display text: Display text in the instrument cluster display, the smart Audio-System or the smart Media-System.

Publication details

Internet

Further information about smart vehicles and about Daimler AG can be found on the following websites:

<http://www.smart.com>

<http://www.daimler.com>

Editorial office

©Daimler AG: not to be reprinted, translated or otherwise reproduced, in whole or in part, without written permission from Daimler AG.

Vehicle manufacturer

Daimler AG
Mercedesstraße 137
70327 Stuttgart
Germany

About this Operator's Manual

We urge you to read this Operator's Manual carefully and familiarize yourself with the vehicle before driving. For your own safety and a longer vehicle life, follow the instructions and warning notices in this Operator's Manual. Ignoring them could result in damage to the vehicle or personal injury to you or others.

This Operator's Manual provides information on the most important functions of your vehicle.

The equipment or product designation of your vehicle may vary depending on:

- Model
- Order
- Country specification
- Availability

The illustrations in this Operator's Manual show a left-hand-drive vehicle. On right-hand-drive vehicles, the layout of components and controls differs accordingly.

smart reserves the right to introduce changes in the following areas:

- Design
- Equipment
- Technical features

The equipment in your vehicle may therefore differ from that shown in the descriptions and illustrations.

Integral parts of the vehicle include:

- Operator's Manual
- Maintenance Booklet
- Equipment-dependent Supplements

Keep copies of the documents in the vehicle at all times. If you sell the vehicle, always pass all documents on to the new owner.

Your Operator's Manuals:



Digital on the Internet

The Operator's Manual on the Internet provides you with convenient access to all of the information relevant to your vehicle and multimedia system. It also offers helpful animations, exciting background information and various search options.



Digital as an app

Using the smart guides app, you can call up all of the information relevant to

your vehicle and multimedia system online on your phone or as a download regardless of the status of your network connection. Available for smartphones and tablets.

Please note that the smart guides app may not currently be available in your country.

Index	4	Acoustic presence indicator	55
Introduction	19	Driving economically	56
Protection of the environment	19	Braking correctly	59
Smart genuine parts	19	Driving on wet roads	60
Warranty for the smart Audio-System and smart Media-System	20	Winter driving	60
Vehicle equipment	20	Using cruise control	60
Service and vehicle operation	20	Charging the high-voltage battery	61
Operating safety	21	Ensuring good visibility	68
QR codes for rescue card	24	Switching on the lighting	68
Data stored in the vehicle	24	Using the interior lighting	69
Information on copyright	26	Using the windshield wiper	70
At a glance	27	Folding the sun visor to the side	71
Dashboard	27	Feeling comfortable in the vehicle interior	72
Multifunction steering wheel	28	Locking and unlocking the doors from the inside	72
Center console with drawer	29	Understanding the reversing feature	72
Overhead control panel	30	Opening and closing the windows	73
Door control panel	31	Using the soft top (smart fortwo cabrio)	73
Displays shown in the instrument cluster and the display	32	Operating the climate control system	77
Safety	33	Activating/deactivating the seat heating and steering wheel heating ...	79
Activating and deactivating the panic alarm	33	Using the accessories	79
Occupant safety	33	Parking and getting out	82
Children in the vehicle	42	Parking	82
Pets in the vehicle	45	Locking the vehicle	82
Driving safely	45	Arming and disarming the anti-theft alarm system	82
Entering and setting up	48	Operating the on-board computer	83
Understanding functions of the SmartKey	48	Overview of the on-board computer ...	83
Opening the door	48	Calling up displays	83
Correct driver's seat position	48	Setting values	85
Adjusting the seats	49	Using the smart Audio-System	87
Adjusting the mirrors	50	Operating and setting the smart Audio-System	87
Driving	52	Listening to the radio	89
Starting the engine	52	Using a mobile phone	90
Pulling away	52		
Automatic transmission	54		
Using the turn signals	55		

Operating external data carriers	92
Using the smart Media-System	
Operating and setting up the smart Media-System	94
Listening to the radio	98
Calling up electric drive displays	99
Using a mobile phone	100
Connecting and operating external data carriers	103
Viewing images	104
Video playback	105
Using the navigation system	105
Managing apps	114
Loading and stowing	
Stowing small objects	116
Stowing luggage and large objects ...	117
Using the trunk partition	119
Removing/installing the charging cable bag	120
Observing the tire and loading information	121
Maintenance and care	
Useful information	124
Removing/installing the subwoofer ..	124
Opening and closing the service cover	124
Checking and adding service products	126
Checking wheels and tires	127
Obtaining information on tires	128
Changing a wheel	134
Using the tire pressure monitor	138
Checking the tire pressures	139
Using winter tires	142
Using snow chains	142
Changing the window wiper blades ..	143
Cleaning the vehicle	144
Observing service due dates	148
Parking the vehicle for a long period	148

Dealing with accidents and breakdowns	
Securing the vehicle in the event of an accident or a breakdown	149
Removing the vehicle tool tray	150
Sealing tires using the TIREFIT kit ...	150
Towing the vehicle	152
Manually releasing the selector lever lock	154
Replacing the bulbs	155
Changing fuses	157
Replacing the SmartKey battery	158
Opening a door with the emergency release	159
Locking the doors in an emergency ..	159

Practical advice	
Notes on display messages	161
Locking and unlocking	161
Visibility, occupants, air bags	163
Engine, brakes, transmission	165
Charging process	167
Driving safety systems	170
Driver assistance systems	175
Battery, lights, heating	176
smart Audio-System and smart Media-System	177

Technical data	
Obtaining technical data	180
Reading out vehicle data	180
Service products	181
Climate control system refrigerant ...	181
Bulb types	182
Fuse allocation	183
Radio type approvals for the tire pressure monitor	185
Installing two-way radios and mobile phones (RF transmitters)	185

1, 2, 3 ...

12 V socket

see Socket (12 V)

A**ABS (Anti-lock Braking System)**

- Display message 170
- Function/notes 45
- Warning lamp (yellow) 170

Acceleration

see Kickdown

Acoustic presence indicator

- Function/notes 55

Air bag

- Installation locations 37
- Limited protection 38
- Overview 37

Air bags

- Deployment 34
- Front air bag (driver, front passenger) 37
- Head bag 37
- Knee bag 37
- PASSENGER AIR BAG indicator lamps 39
- Protection provided 38
- Side impact air bag 37
- Window curtain air bag 37

Air distribution

- Setting (automatic climate control) 77

Air pressure

see Tire pressure

Air vents

- Important safety notes 78
- Setting 78

Air vents

see Air vents

Air-recirculation mode

- Switching on/off (automatic climate control) 77

Alarm

- Anti-theft alarm system 82
- Switching off 82

Ambient lighting

- Setting the brightness 86
- Switching on/off 86

Animals

see Pets in the vehicle

Anti-entrapment feature

see Reversing feature

Anti-lock Braking System

see ABS (Anti-lock Braking System)

Anti-skid chains

see Snow chains

Anti-theft alarm system

- Switching off the alarm 82
- Switching on/off 82

Apps

- Displaying/calling up 115
- General notes 114
- Installing 115

Ashtray

..... 80

Audio-System

- Connecting a mobile phone 90
- Connecting Bluetooth® audio devices 93
- Connecting external audio equipment (AUX) 93
- Operating 87
- Operating the radio 89
- Operating via the mobile phone 88
- Overview 87
- Setting the time 88
- Smartphone bracket 88
- System settings 88
- Troubleshooting 177
- Using external devices 87
- Volume/sound settings 89
- Warranty 20

Authorized workshop

see Qualified specialist workshop

Automatic car wash (care) 144**Automatic climate control**

- Activating/deactivating air-recirculation mode 77
- Cooling with air dehumidification 77
- Defrosting the rear window 78
- Defrosting the windshield 78
- Increasing/decreasing the blower speed 77
- Setting air distribution 77
- Setting the temperature 77
- Switching on/off 77

- Windows fogged up 78
- Automatic headlamp mode** 68
- Automatic transmission**
- Engaging neutral 55
 - Engaging reverse gear 55
 - Engaging the park position 55
 - Important safety notes 54
 - Kickdown 55
 - Manually releasing the selector lever lock 154
 - Pulling away 52
 - Starting the engine 52
 - Transmission positions 55
- AUX jack**
- Audio-System 87
 - Media-System 94
- B**
- Battery**
- Display message 176
- Battery**
- see High-voltage battery
- Battery (SmartKey)**
- Important safety notes 158
 - Replacing 158
- Battery (vehicle)**
- see High-voltage battery
- Belt**
- see Seat belt
- Belt warning** 37
- Blower speed**
- Increasing or decreasing (automatic climate control) 77
- Bluetooth®**
- Activating the mobile phone (Audio-System) 90
 - Activating the mobile phone (Media-System) 100
 - Authorizing the function for the mobile phone (Audio-System) 90
 - Connecting a device (Media-System) 103
 - Operating (Audio-System) 93
 - Switching on/off (Media-System) 100
- Brake fluid**
- Display message 166
- Brake force distribution**
- see EBD (electronic brake force distribution)
- Brake lamp**
- Replacing bulbs 156
- Brake lamps**
- Display message 177
- Brakes**
- ABS 45
 - Braking on downhill gradients 59
 - Braking on wet road surfaces 59
 - EBD 47
 - Important safety notes 59
 - Limited braking performance on salt-treated roads 59
 - Parking brake 53
 - Riding tips 59
 - Warning lamp 166
- Breakdown**
- Towing away 152
 - see Flat tire
- C**
- Car**
- see Vehicle
- Car wash**
- see Care
- Care**
- Car wash 144
 - Carpets 147
 - Cleaning the interior 146
 - Cleaning the roof lining (smart fortwo coupe) 147
 - Display 146
 - Exterior 144
 - Exterior lights 146
 - High-voltage battery 63
 - Interior 146
 - Notes 144
 - Paint 146
 - Plastic trim 147
 - Power washer 144
 - Roof lining 146
 - Seat belt 147
 - Seat cover 147
 - Selector lever 147
 - Sensors 145

- Soft top system 146
- Steering wheel 147
- Trim pieces 148
- Washing by hand 144
- Wheels 145
- Windows 145
- Wiper blades 145
- Center console**
 - Overview 29
- Central locking**
 - Automatic locking 72
 - Locking/unlocking (SmartKey) 82
- Changing bulbs**
 - see Replacing bulbs
- Changing the route**
 - Navigation 109
- Charge current**
 - Setting (charging cable) 65
- Charge level display** 57
- Charging cable**
 - Connecting 66
 - Controls 65
 - Display message 167
 - Removing 66
 - Storing 67
 - Warming up 64
- Charging cable bag**
 - Removing/fitting 120
- Charging current**
 - Display messages 167
- Child seat**
 - Forward-facing restraint system 44
 - On the front-passenger seat 44
 - Rearward-facing restraint system 44
 - Top Tether 43
- Children**
 - Restraint systems 42
 - Special seat belt retractor 43
- Cigarette lighter** 79
 - see Care
- Climate control**
 - Automatic climate control 77
 - General notes 77
 - Refrigerant 181
 - Refrigerant filling capacity 182
 - Setting the air vents 78
- Clock**
 - Setting the time (Media-System) 96
- Cockpit**
 - Overview 27
- COMAND display**
 - Cleaning 146
- Connectivity manager** 115
- Consumption details**
 - Calling up (Media-System) 99
- Controlling speed**
 - see Cruise control
- Coolant**
 - Checking the coolant level and adding coolant 126
 - Important safety notes 126
- Cooling**
 - see Climate control
- Cooling with air dehumidification**
 - Automatic climate control 77
- Copyright** 26
- Cornering light function** 69
- Cover (front)**
 - see Service cover
- Crosswind Assist** 46
- Cruise control**
 - Activating 61
 - Buttons 61
 - Calling up the speed last stored 61
 - Canceling cruise control 61
 - Deactivating 61
 - Display message (color display) .. 176
 - Function/notes 60
 - General notes 60
 - Important safety notes 60
 - Increasing/decreasing the speed 61
 - Storing and maintaining current speed 61
- Cup holder**
 - Center console 116
 - Important safety notes 116
- Cup holder**
 - see Cup holder
- Customer Assistance Center (CAC)** 24
- Customer Relations Department** 24

D

Dashboard	
see Cockpit	
Data	
see Technical data	
Data carriers	
see External data carriers	
Data sharing	
Managing	115
Daytime running lamp mode	
see Daytime running lights	
Daytime running lights	68
Dealership	
see Qualified specialist workshop	
Declarations of conformity	22
Diagnostics connection	22
Digital speedometer	
Displaying	86
Display	
Color	83
Display message	
Color display	85
Display messages	
General notes	161
Distance warning function	
Function/notes	45
Warning lamp	175
Door	
Unlocking (SmartKey)	48
Doors	
Automatic locking (switch)	72
Central locking/unlocking (SmartKey)	82
Control panel	31
Display message	162
Emergency locking	160
Emergency unlocking	159
Opening (from inside)	72
Drinking and driving	53
Driver's door	
see Doors	
Driver's seat	
see Seat	
Driving economically	
eco score display	57
General notes	56

Driving noise

 see Acoustic presence indicator

Driving safety system

Crosswind Assist	46
Limits of the driving safety systems	45

Driving safety systems

ABS (Anti-lock Braking System)	45
Distance warning function	45
EBD (electronic brake force distribution)	47
ESP® (Electronic Stability Program)	46
ETS (Electronic Traction System)	46

Driving systems

Cruise control	60
----------------------	----

Driving tips

Brakes	59
Downhill gradient	59
Drinking and driving	53
Driving in winter	60
Driving on flooded roads	60
Driving on wet roads	60
Hydroplaning	60
Icy road surfaces	60
Limited braking efficiency on salted roads	59
Pulling away	52
see Driving economically	

Dynamic handling control system

 see ESP® (Electronic Stability Program)

E

EBD (electronic brake force distribution)

Function/notes	47
----------------------	----

EBD (Electronic Brake-force Distribution)

Indicator lamp	170
----------------------	-----

ECO mode

Switching on/off	56
------------------------	----

eco score

Calling up	57
Comparing a trip	58
Display (color display)	57

- Evaluating the current trip 58
 - Function/notes 57
 - Resetting data 58
 - Saving a trip 58
 - Electronic Brake-force Distribution**
see EBD (electronic brake force distribution)
 - Electronic Stability Program**
see ESP® (Electronic Stability Program)
 - Electronic Traction System**
see ETS (Electronic Traction System)
 - Emergency release**
Driver's door 159
Vehicle 159
 - Emergency Tensioning Devices**
Activation 34
 - Energy**
Displaying the current consumption (color display) 84
 - Energy consumption**
High-voltage battery 63
 - Energy flow display**
Calling up (Media-System) 99
Color display 84
 - Engine**
Starting problems 165
Starting the engine with the SmartKey 52
Switching off 82
 - Engine electronics**
Notes 21
 - Entering a destination**
Navigation 106
 - Environmental protection**
High-voltage battery 19
 - ESP® (Electronic Stability Program)**
Crosswind Assist 46
Display message 171
General notes 46
Important safety information 46
Warning and indicator lamps 171
 - ETS (Electronic Traction System)** 46
 - Exterior lighting**
Cleaning 146
see Lights
 - Exterior mirrors**
Adjusting 50
Out of position (troubleshooting) 163
 - External audio equipment (AUX)**
Connecting (Audio-System) 93
 - External data carriers**
Connecting (Audio-System) 87
Connection (Media-System) 103
Operating (Audio-System) 92
Operation (Media-System) 103
- F
- Factory settings**
Resetting (Media-System) 96
 - Favorites**
Creating (Media-System) 97
Managing (Media-System) 97
 - Fender**
see Front wheel arch
 - Flat tire**
Preparing the vehicle 149
TIREFIT kit 150
 - Floor mats** 80
 - Fog lamps**
Switching on/off 69
 - Fording**
On flooded roads 60
 - Forward collision warning**
Display message 175
 - Frequencies**
Mobile phone 185
Two-way radio 185
 - Front air bag** 37
 - Front cover**
see Service cover
 - Front wheel arch**
Removing/installing the cover 156
 - Front wheel arch cover**
Installing/removing 156
 - Front-passenger front air bag deactivation system**
PASSENGER AIR BAG indicator lamps 39
Status indicator 39
 - Front-passenger seat**
Folding down 119

- Front-passenger seat**
 - see Seat
 - Frontal area cover**
 - see Service cover
 - Fuses**
 - Allocation chart 183
 - Before changing 158
 - Dashboard fuse box 158
 - Important safety notes 157
 - Opening the fuse box 158
 - Fuses**
 - see Fuses
- G**
- Genuine parts** 19
 - Glove box** 116
- H**
- Hand brake**
 - see Parking brake
 - Hands-free system**
 - see Mobile phone
 - Hazard warning lamps**
 - Switching on/off 149
 - Head bags** 37
 - Headlamps**
 - see Automatic headlamp mode
 - Heating**
 - see Climate control
 - High beam flasher** 68
 - High-beam headlamps**
 - Replacing bulbs 155
 - Switching on/off 68
 - High-voltage battery**
 - Battery care 63
 - Charge level display 56
 - Charging (charging station) 67
 - Charging (mains socket) 65
 - Charging (wallbox) 67
 - Charging cable warming 64
 - Condition of charge 56
 - Cruise range 63
 - Discharged battery 63
 - Display message 176
 - Energy consumption 63
 - Important safety notes 61
 - Indicator lamp (vehicle socket) 64
 - Method of operation 62
 - Outside temperatures 63
 - Problems with the charging process 167
 - Protective equipment 63
 - READY indicator 176
 - Terms of use 63
 - Vehicle socket 64
 - Warning and indicator lamps 176
 - High-voltage electrical system**
 - Automatic switch-off 23
 - Danger of electric shock 23
 - Operating safety 23
 - Vehicle fire 23
 - Home address**
 - Entering and saving 107
 - Home address (navigation)**
 - see Home address
 - Hydroplaning** 60
- I**
- i-Traffic**
 - Traffic reports 99
 - Ignition lock**
 - see Key positions
 - Image**
 - Playback (Media-System) 104
 - Immobilizer** 82
 - Indicator and warning lamps**
 - Battery 176
 - Indicator lamps**
 - see Warning and indicator lamps
 - Instrument cluster**
 - Overview 32
 - Warning and indicator lamps 32
 - Instrument cluster lighting**
 - Adjusting 86
 - Instrument lighting**
 - see Instrument cluster lighting
 - Interior lighting** 69
 - Replacing bulbs 157
 - Setting the ambient lighting 86
 - Setting the ambient lighting (color display) 70
 - Switching on/off 69
 - Intermittent wiping** 70

- J**
- Jack**
Using 135
- K**
- Key**
Position in the ignition lock 52
- Keyboard**
Changing (Media-System) 96
- Kickdown** 55
- Knee bag** 37
- L**
- Lamps**
see Warning and indicator lamps
- Language**
Selecting (Media-System) 96
- Language (on-board computer)** 86
- License plate lamp**
Changing bulbs 157
- Lighting**
Setting the ambient lighting 86
- Lights**
Automatic headlamp mode 68
Cornering light function 69
Display message 177
Fog lamps 69
Hazard warning lamps 149
High beam flasher 68
High-beam headlamps 68
Light switch 68
Low-beam headlamps 68
Parking lamps 69
Rear fog lamp 69
Turn signals 55
see Interior lighting
see Replacing bulbs
- Loading guidelines** 117
- Locking**
see Central locking
- Locking (doors)**
Automatic 72
Emergency locking 160
From inside (central locking button) 72
- Loudspeaker**
see Subwoofer
- Low-beam headlamps**
Replacing bulbs 155
Switching on/off 68
- M**
- M+S tires (winter tires)** 142
- Making a call**
Media-System 102
- Malfunction message**
see Display message
- Manually releasing the selector lever lock (automatic transmission) ...** 154
- Media system**
Creating favorites 97
System menu 96
System settings 96
Volume/tone settings 97
- Media-System**
Buttons on the multifunction steering wheel 94
Calling up menus 95
Changing the on-screen key-board 96
Connectivity manager 115
Consumption details 99
Controls 94
Data connectivity 114
Display settings 96
eco score 57
Enabling data sharing 115
Energy flow display 99
Home screen 95
Image playback 104
Installing apps 115
Navigation menu 105
Navigation system 105
Operating the radio 98
Overview 94
Problem solving 177
Selecting the home screen display 96
Selecting the language 96
Setting the time 96
Setting warning tones 97
Status and information 96

- Switching on/off 95
 - Video playback 105
 - Warranty 20
 - Message memory (color display) 85**
 - Mirror**
 - see Exterior mirrors
 - MirrorLink™**
 - Using 101
 - Mirrors**
 - see Rear-view mirror
 - Mobile phone**
 - Automatically downloading data (Media-System) 100
 - Connecting (Audio-System) 90
 - Connecting (Media-System) 100
 - Frequencies 185
 - Installation 185
 - Loading and updating the phone book (Audio-System) 91
 - Setting the sound (Audio-System) 91
 - Transmission output (maximum) 185
 - Using MirrorLink™ 101
 - Using the telephone (Media-System) 102
 - Model series**
 - see Vehicle identification plate
 - Mounting wheels**
 - Mounting a new wheel 137
 - Preparing the vehicle 135
 - Raising the vehicle 135
 - Removing a wheel 135
 - Securing the vehicle against rolling away 149
 - Multi-functional seat**
 - see Seat
 - Multifunction steering wheel**
 - Overview 28
-
- N**
- Navigation**
 - Alternative route 109
 - Changing the route 109
 - Current location 111
 - Destination memory 107
 - Entering a destination 106
 - Entering a destination by address 106
 - Entering a destination using geo-coordinates 107
 - Entering a destination using the map 107
 - Entering a point of interest 107
 - Entering/saving your home address 107
 - Reading map data 106
 - Route details 109
 - Selecting a destination from the list of last destinations 107
 - Setting route planning 110
 - Setting the voice 113
 - Starting 105
 - Starting route calculation 108
 - Switching announcements on/off 110
 - System settings 113
 - TomTom Services 112
 - Traffic information 111
 - Troubleshooting 178
 - Way points 109
-
- O**
- Occupant safety**
 - Air bags 37
 - Belt warning 37
 - Children in the vehicle 42
 - PASSENGER AIR BAG indicator lamps 39
 - Pets in the vehicle 45
 - Restraint system 33
 - Restraint system warning lamp 33
 - Seat belt 35
 - On-board computer**
 - Calling up displays (color display) 83
 - Important safety notes 83
 - Operation 83
 - Overview 83
 - Selecting the language 86
 - Setting/resetting values (color display) 85
 - On-board diagnostic interface**
 - see Diagnostics connection

- On-screen keyboard**
 Changing (Media-System) 96
- Operating safety**
 Declaration of conformity 22
 High-voltage electrical system 23
- Operating system**
 see On-board computer
- Operator's Manual**
 Vehicle equipment 20
- Outside temperature display** 83
 Setting the units 86
- Outside temperatures**
 High-voltage battery 63
- Overhead control panel** 30
- Overvoltage protection**
 High-voltage battery 63
- P**
- Paint code number** 180
- Paintwork (cleaning instructions)** 146
- Panic alarm** 33
- Park brake**
 see Parking brake
- Parking** 82
 Engaging park position 55
 Important safety notes 82
 Parking brake 53
- Parking brake**
 Display message 166
 General notes 53
 Warning lamp 166
- Parking lamps**
 Switching on/off 69
- PASSENGER AIR BAG**
 Indicator lamps 39
 Problem (malfunction) 164
- Pets in the vehicle** 45
- Point of interest**
 Entering 107
- Power display** 57
- Power windows**
 see Side windows
- Pre-entry climate control and charging**
 Color display 85
- Pre-entry climate control at departure time**
 Setting departure time 78
 Smart-Charging 78
- Protection against theft**
 Anti-theft alarm system 82
- Protection of the environment**
 General notes 19
- Pulling away**
 General notes 52
 Hill start assist 54
- Q**
- QR code**
 Rescue card 24
- Qualified specialist workshop** 23
- R**
- Radio**
 Display mode 98
 i-Traffic (traffic reports) 99
 Operating (Audio-System) 89
 Operation (Media-System) 98
- Radio text**
 Displaying (Audio-System) 90
 Displaying (Media-System) 99
- Radio type approvals**
 Tire pressure monitor 185
- Radio-wave reception/transmission in the vehicle**
 Declaration of conformity 22
- Rain and light sensor (display message)** 177
- Rain sensor** 70
- Range**
 High-voltage battery 63
- Reading lamp** 69
- Rear fog lamp**
 Replacing bulbs 156
 Switching on/off 69
- Rear lamp**
 Replacing bulbs 156
- Rear soft top**
 Closing 118
 Opening 118

- Rear window defroster**
 - Defrosting the rear window (automatic climate control) 78
 - Rear window wiper**
 - Automatic rear window wiper when backing up 71
 - Replacing the wiper blade 143
 - Switching on/off 71
 - Rear-view mirror** 50
 - Recycling**
 - see Protection of the environment
 - Refrigerant (air-conditioning system)**
 - Important safety notes 181
 - Replacing bulbs**
 - Brake lamp 156
 - High-beam headlamps 155
 - Important safety notes 155
 - Installing/removing the cover (front wheel arch) 156
 - Interior lighting 157
 - LED 156
 - License plate lamp 157
 - Low-beam headlamps 155
 - Overview of bulb types 182
 - Rear fog lamp 156
 - Rear lamp 156
 - Reversing lamp 156
 - Turn signal lamp (rear) 156
 - Replacing the bulb**
 - Turn signal lamp (front) 156
 - Rescue card** 24
 - Restraint system**
 - Display message 164
 - Function during an accident 34
 - Limited protection 33
 - Operational readiness 33
 - Protection provided 33
 - System self-test 33
 - Warning lamp 164
 - Warning lamp (function) 33
 - Restraint systems**
 - Malfunction 33
 - Reverse gear**
 - Engaging (automatic transmission) 55
 - Reversing feature**
 - Side windows 72
 - Reversing lamp**
 - Replacing bulbs 156
 - Roadside Assistance (breakdown)** 20
 - Roof lining and carpets (cleaning guidelines)** 147
- S**
- Safety**
 - Children in the vehicle 42
 - see Occupant safety
 - see Operating safety
 - Safety system**
 - see Driving safety system
 - SD card**
 - Connecting (Media-System) 103
 - Reading map data 106
 - SD card slot 94
 - Seat**
 - Correct driver's seat position 48
 - Folding the front-passenger seat down 119
 - Seat belt**
 - Limited protection 35
 - Protection provided 35
 - Seat belts**
 - Cleaning 147
 - Fastening 36
 - Releasing 36
 - Warning lamp 163
 - Warning lamp (function) 37
 - Seat heating** 79
 - Seats**
 - Adjusting (manually) 49
 - Cleaning the cover 147
 - Important safety notes 49
 - Switching seat heating on/off 79
 - Selector lever**
 - Cleaning 147
 - Selector lever**
 - see Automatic transmission
 - Sensors (cleaning instructions)** 145
 - Service appointment**
 - Display message 167
 - Service Center**
 - see Qualified specialist workshop
 - Service cover** 124

- Service display**
 Calling up (color display) 85
- Service products**
 Brake fluid 181
 Coolant (engine) 126
 Important safety notes 126
 Refrigerant (air-conditioning system) 181
 Washer fluid 181
- Side bars**
 Closing the stowage well 76
 Mounting 76
 Removing 74
 Stowing 75
- Side impact air bag** 37
- Side turn signal lamps**
 Replacing bulbs 156
- Side windows**
 Cleaning 145
 Important safety information 73
 Opening/closing 73
 Problem (malfunction) 162
 Resetting 162
 Reversing feature 72
- smart center**
 see Qualified specialist workshop
- Smart-Charging**
 Function/notes 78
- SmartKey**
 Changing the battery 158
 Loss 161
 Opening the soft top 74
 Problem (malfunction) 161
 Starting the engine 52
- SmartKey**
 see SmartKey
- SmartKey positions (ignition lock)** 52
- Smartphone**
 Inserting/removing 88
 Installing the bracket 88
 Operating the Audio-System
 via the mobile phone 88
- Snow chains** 142
- Socket (12 V)**
 Center console 80
- Socket (high-voltage battery)**
 see Vehicle socket
- Soft top**
 Cleaning 146
 Closing 74
 Closing the rear soft top 118
 Closing the stowage well with-
 out the side bars 76
 Important safety notes 73
 Opening 74
 Opening the rear soft top 118
 Removing the side bars 74
 Stowing the side bars 75
- Sound**
 Setting (Audio-System) 89
 Setting (Media-System) 97
- Sound generator**
 see Acoustic presence indicator
- Speakers**
 see Subwoofer
- Special seat belt retractor** 43
- Specialist workshop** 23
- Speedometer**
 Digital 83
 Displaying (digital speedome-
 ter) 86
 General information (digital
 speedometer) 85
 see Instrument cluster
- Starting (engine)** 52
- Starting the engine**
 see Starting (engine)
- Station**
 Setting (Media-System) 99
- Station list**
 Updating (Media-System) 99
- Station search**
 Audio-System 90
- Stations**
 Setting (Audio-System) 89
 Setting a stored station (Audio-
 System) 90
 Setting the station list (Audio-
 System) 89
 Storing (Audio-System) 90
- Steering**
 Display message 174
 Warning lamps 174
- Steering wheel**
 Button overview 28

- Cleaning 147
 - Steering wheel heating**
 - Switching on/off 79
 - Stowage areas** 116
 - Stowage compartment in the tail-gate** 117
 - Stowage compartments**
 - Center console 116
 - Cup holders 116
 - Door 116
 - Eyeglasses compartment 116
 - Glove box 116
 - Important safety information 116
 - Subwoofer**
 - Fitting/removing 124
 - Sun visor** 71
- T**
- Tailgate**
 - Opening dimensions 180
 - Opening/closing 117
 - Warning lamp 162
 - Tailgate (smart fortwo cabrio)**
 - Opening/closing 118
 - Technical data**
 - Information 180
 - Vehicle data 180
 - Telephone book**
 - Loading (Audio-System) 91
 - Telephone operation**
 - Audio-System 91
 - Temperature**
 - Setting (automatic climate control) 77
 - Time**
 - Setting (Audio-System) 89
 - Setting (color display) 86
 - Setting the time format (color display) 86
 - Tire pressure**
 - Checking/correcting 141
 - Display message 172
 - Important safety notes 139
 - Not reached (TIREFIT) 151
 - Reached (TIREFIT) 152
 - Recommended 139
 - Tire pressure monitor**
 - Function/notes 138
 - Radio type approval for the tire pressure monitor 185
 - Restarting 138
 - Starting 86
 - Warning lamp 172
 - TIREFIT kit** 150
 - Tires**
 - Aspect ratio (definition) 133
 - Average weight of the vehicle occupants (definition) 132
 - Bar (definition) 132
 - Changing a wheel 134
 - Characteristics 132
 - Checking 127
 - Curb weight (definition) 133
 - Definition of terms 132
 - Direction of rotation 137
 - Distribution of the vehicle occupants (definition) 134
 - DOT (Department of Transportation) (definition) 132
 - GAWR (Gross Axle Weight Rating) (definition) 133
 - GVW (Gross Vehicle Weight) (definition) 133
 - GVWR (Gross Vehicle Weight Rating) (definition) 133
 - Important safety notes 127
 - Increased vehicle weight due to optional equipment (definition) .. 133
 - Kilopascal (kPa) (definition) 133
 - Labeling (overview) 129
 - Load bearing index (definition) ... 134
 - Load index 131
 - Load index (definition) 133
 - M+S tires (winter tires) 142
 - Maximum load on a tire (definition) 133
 - Maximum loaded vehicle weight (definition) 133
 - Maximum permissible tire pressure (definition) 133
 - Maximum tire load 131
 - Maximum tire load (definition) 133
 - Optional equipment weight (definition) 134

- PSI (pounds per square inch)
(definition) 133
- Rules for new tires 135
- Service life 135
- Sidewall (definition) 134
- Snow chains 142
- Speed rating (definition) 133
- Storing 138
- Structure and characteristics
(definition) 132
- Temperature 129
- TIN (Tire Identification Number) (definition) 134
- Tire bead (definition) 134
- Tire pressure (definition) 134
- Tire pressures (recommended) 133
- Tire size designation, load-bearing capacity, speed rating ... 129
- Tire tread 127
- Tire tread (definition) 134
- Total load limit (definition) 134
- Traction 128
- Traction (definition) 134
- Tread wear 128
- Uniform Tire Quality Grading Standards 128
- Uniform Tire Quality Grading Standards (definition) 132
- Wear indicator (definition) 134
- Wheel rim (definition) 133
- see Flat tire
- TomTom Services**
- Activating 112
- Introduction 112
- My Services menu 112
- Subscription status 112
- Traffic information menu 112
- Tool**
- see Vehicle tool kit
- Top Tether** 43
- Total distance recorder**
- Color display 84
- Setting the display unit 86
- Touchscreen**
- Confirming settings with "Done" 95
- Operating the touchscreen 95
- Towing away**
- Important safety guidelines 152
- Installing the towing eye 154
- Removing the towing eye 154
- With both axles on the ground 154
- Traction system**
- see ETS (Electronic Traction System)
- Traffic reports**
- Switching on/off 90
- Transmission**
- see Automatic transmission
- Transporting the vehicle** 154
- Trip computer**
- Displays 84
- Trip meter**
- Color display 84
- Trip odometer**
- Displays (color display) 84
- Trunk**
- see Tailgate
- Trunk (front)**
- see Service cover
- Trunk partition**
- Installing 119
- Removing 120
- Turn signal lamp (front)**
- Replacing the bulb 156
- Turn signal lamp (rear)**
- Replacing bulbs 156
- Turn signals**
- Switching on/off 55
- Turn signals**
- see Turn signals
- Two-way radio**
- Frequencies 185
- Installation 185
- Transmission output (maximum) 185
- Type identification plate**
- see Vehicle identification plate

U

Unit of measurement for distance

- Setting 86

Units

- Setting (on-board computer) 86

- Unlocking**
 - From inside the vehicle (central unlocking button) 72
 - With emergency key element 159
 - USB device**
 - Connecting (Audio-System) 92
 - Connection (Media-System) 103
 - Operating (Audio-System) 92
 - USB port**
 - Audio-System 87
 - Media-System 94
- V**
- Values**
 - Setting (color display) 85
 - Vehicle**
 - Correct use 24
 - Data acquisition 24
 - Electronics 21
 - Equipment 20
 - Loading 121
 - Locking (in an emergency) 159
 - Locking (SmartKey) 82
 - Maintenance 20
 - Operating safety 21
 - Parking for a long period 148
 - Raising 135
 - Reporting problems 24
 - Securing from rolling away 149
 - Towing away 152
 - Transporting 154
 - Unlocking (in an emergency) 159
 - Unlocking (SmartKey) 48
 - Vehicle data 180
 - Vehicle data** 180
 - Vehicle dimensions** 180
 - Vehicle emergency locking** 160
 - Vehicle identification number**
 - see VIN
 - Vehicle identification plate** 180
 - Vehicle SmartKey**
 - see SmartKey
 - Vehicle socket**
 - High-voltage battery 64
 - Indicator lamp 64
 - Problems during the charging process 167
 - Vehicle tool kit** 150
 - Ventilation**
 - see Climate control
 - Video**
 - Playback (Media-System) 105
 - VIN** 180
 - Voice Control System**
 - Entering a destination in the navigation system 107
 - Problems with the voice control system 178
 - Starting an application 94
 - Voltage range**
 - High-voltage battery 62
 - Volume**
 - Adjusting automatically 89
 - Setting (Audio-System) 89
 - Setting (Media-System) 97
- W**
- Warning and indicator lamps**
 - ABS 170
 - Brakes 166
 - Distance warning function (red) .. 175
 - EBD 170
 - ESP® (yellow) 171
 - High-voltage battery 176
 - Overview 32
 - Parking brake 166
 - PASSENGER AIR BAG 39
 - PASSENGER AIRBAG OFF 164
 - Restraint system 164
 - Seat belt 163
 - Steering 174
 - Tire pressure monitor 172
 - Warranty** 20
 - Wheel bolt tightening torque** 137
 - Wheels**
 - Changing a wheel 134
 - Checking 127
 - Cleaning 145
 - Important safety notes 127
 - Mounting a new wheel 137
 - Removing a wheel 135
 - Snow chains 142
 - Storing 138
 - Tightening torque 137

- Window curtain air bag** 37
- Windows**
 - see Side windows
- Windshield**
 - Defrosting (automatic climate control) 78
- Windshield washer fluid**
 - see Windshield washer system
- Windshield washer system**
 - Adding washer fluid 127
 - Important safety notes 127
- Windshield wipers**
 - Intermittent wipe 70
 - Problem (malfunction) 163
 - Rain sensor 70
 - Rear window wiper 71
 - Replacing the wiper blades 143
 - Switching on/off 70
 - Wiping with windshield washer fluid 70
- Winter driving**
 - Slippery road surfaces 60
 - Snow chains 142
- Winter operation**
 - General notes 60
- Winter tires**
 - M+S tires 142
- Wiper blades**
 - Cleaning 145
 - Replacing (rear window) 143
 - Replacing (windshield) 143
- Workshop**
 - see Qualified specialist workshop

Protection of the environment

General notes

Environmental note

Daimler's declared policy is one of comprehensive environmental protection.

Our objectives are to use the natural resources which form the basis of our existence on this planet sparingly and in a manner which takes the requirements of both nature and humanity into consideration.

You too can help to protect the environment by operating your vehicle in an environmentally-responsible manner.

Energy consumption and the rate of engine, transmission, brake and tire wear depend on the following factors:

- operating conditions of your vehicle
- your personal driving style

You can influence both factors. Therefore, please bear the following in mind:

Operating conditions:

- observe the correct tire pressure.
- avoid carrying unnecessary weight.
- remove the roof rack once you no longer need it.
- a regularly serviced vehicle will contribute to environmental protection. You should therefore adhere to the service intervals.
- all maintenance work should be carried out at a qualified specialist workshop.

Personal driving style:

- drive carefully and maintain a safe distance from the vehicle in front.
- avoid frequent, sudden acceleration and braking.
- monitor the vehicle's energy consumption.

High-voltage battery

Environmental note

Have a defective high-voltage battery disposed of in an environmentally-responsible manner. Contact a specialist workshop that is qualified to work on smart electric drive vehicles and has the necessary specialist knowledge and tools to carry out the work required. smart recommends that you use a smart Center for this purpose.

Environmental concerns and recommendations

Wherever the Operator's Manual requires you to dispose of materials, first try to regenerate or re-use them. Observe the relevant environmental rules and regulations when disposing of materials. In this way you will help to protect the environment.

smart genuine parts

Environmental note

Daimler AG also supplies reconditioned major assemblies and parts which are of the same quality as new parts. They are covered by the same Limited Warranty entitlements as new parts.

 Air bags and Emergency Tensioning Devices, as well as control units and sensors for these restraint systems, may be installed in the following areas of your vehicle:

- doors
- door pillars
- door sills
- seats
- cockpit
- instrument cluster
- center console

Do not install accessories such as audio systems in these areas. Do not carry out repairs or welding. You could impair the

operating efficiency of the restraint systems.

Have aftermarket accessories installed at a qualified specialist workshop.

Only smart genuine parts or parts of the same quality may be used. In addition, only approved wheels, tires and accessories for the particular type of vehicle may be used. Always specify the vehicle identification number (VIN) when ordering smart genuine parts.

Using parts, tires, wheels or safety-relevant equipment not approved by smart could jeopardize the operational safety of the vehicle. Safety-relevant systems, such as the brake system, may malfunction.

Genuine smart parts are subject to strict quality control. Each part has been specially developed, manufactured or selected for smart vehicles and fine-tuned for them. Therefore, only genuine smart parts should be used.

More than 300,000 different genuine smart parts are available for smart models.

All smart centers maintain a supply of genuine smart parts for necessary service and repair work. In addition, strategically located parts delivery centers provide quick and reliable parts service.

Warranty for the smart Audio-System and smart Media-System

The smart sales organization provides a warranty for a period of 24 months without a kilometer limit for the smart Audio-System and the smart Media-System.

The warranty issuer is the respective sales organization in the country in which the accessory or replacement part was purchased (see list in the Maintenance Booklet).

Vehicle equipment

This Operator's Manual describes all models and all standard and optional equipment available for the vehicle at the time of publication of this Operator's Manual. Country-specific differences are possible. Please note that the vehicle equipment may differ from

certain descriptions and illustrations provided in this manual. This also applies to safety-relevant systems and functions.

The vehicle's original purchase contract documentation contains a list of all the systems in your vehicle. Please contact any smart center to help clarify any questions related to the vehicle equipment and operation.

Service and vehicle operation

Service and warranty information

The smart USA Warranty booklet (USA only) or the Warranty booklet (Canada only) contains detailed information about the warranties covering your smart, including:

- smart USA Limited Warranty (USA only)
- New Vehicle Limited Warranty (Canada only)
- warranty against perforation through corrosion
- smartmove Assistance (Canada only)
- State warranty enforcement laws (Lemon Laws)

Maintenance

The Service and Warranty Booklet describes all the necessary maintenance work which should be done at regular intervals.

Always bring the Service and Warranty Information Booklet with you when bringing the vehicle to an authorized smart center.

The service advisor will record every service for you in the Service and Warranty Booklet.

Roadside Assistance

The smartmove Assistance (Canada) and smart 1 service (USA) Program provides factory trained technical help in the event of a breakdown. Calls to the toll-free Roadside Assistance number

1-800-762-7887 (in USA)

1-877-627-8004 (in Canada)

will be answered by smart Customer Assistance Representatives 24 hours a day, 365 days a year. Roadside Assistance will be pro-

vided in accordance with standard program guidelines which include providing service to the vehicle up to a reasonable distance from a paved roadway. We will make every effort to assist in a breakdown situation, however, the accessibility of your vehicle will be determined by our authorized smart center technician or the tow service provider on a case-by-case basis and may be a factor in our ability to respond. Additional charges may be applicable for a breakdown location determined not to be a reasonably accessible roadside location as determined by our authorized technician and tow service provider.

For additional information refer to the smart Roadside Assistance Program brochure (USA) or the Warranty Booklet (Canada) in your vehicle literature portfolio.

Change of address or change of ownership

In the USA: If you change your address, be sure to send in the "Information Change Card" found in the Warranty Information Booklet.

In Canada: If you change your address, be sure to send in the "Change of Address Notice" found in the Warranty Booklet, or simply call the Customer Service at 1-800-387-0100.

Maintaining your current address information with smart will enable us to contact you should important new information about the vehicle, such as recalls, become available.

If you sell your smart, please leave all literature with the vehicle to make it available to the next operator.

In the USA: If you bought this vehicle used, be sure to send in the "Information Change Card" found in the Warranty Information Booklet.

In Canada: If you bought this vehicle used, be sure to send in the "Notice of Pre-Owned Vehicle Purchase" found in the Warranty Booklet, or call the Customer Service at 1-800-387-0100.

Operating your vehicle outside the USA or Canada

If you plan to operate your vehicle in foreign countries, please be aware that service facilities or replacement parts may not be readily available.

Operating safety

Important safety notes

WARNING

If you do not have the prescribed service/maintenance work or any required repairs carried out, this can result in malfunctions or system failures. There is a risk of an accident.

Always have the prescribed service/maintenance work as well as any required repairs carried out at a qualified specialist workshop.

WARNING

If you operate information systems and communication equipment integrated in the vehicle when driving, you may be distracted from the traffic situation. You could also lose control of the vehicle. There is a risk of an accident.

Only operate this equipment when the traffic situation permits. If you are not sure that this is possible, park the vehicle paying attention to traffic conditions and operate the equipment when the vehicle is stationary.

WARNING

Modifications to electronic components, their software as well as wiring can impair their function and/or the function of other networked components. In particular, systems relevant to safety could also be affected. As a result, these may no longer function as intended and/or jeopardize the operating safety of the vehicle. There is an increased risk of an accident and injury.

Never tamper with the wiring as well as electronic components or their software. You should have all work to electrical and electronic equipment carried out at a qualified specialist workshop.

You must observe the legal requirements for the country in which you are currently driving when operating information systems and communication devices integrated into the vehicle:

! There is a risk of damage to the vehicle if:

- the vehicle becomes stuck, e.g. on a high curb or an unpaved road
- you drive too fast over an obstacle, e.g. a curb, speed bumps or a pothole in the road
- a heavy object strikes the underbody or parts of the chassis

In situations like this, the body, the underbody, chassis parts, wheels or tires could be damaged without the damage being visible. Components damaged in this way can unexpectedly fail or, in the case of an accident, no longer withstand the strain they are designed to.

In such situations, have the vehicle checked and repaired immediately at a qualified specialist workshop. If on continuing your journey you notice that driving safety is impaired, pull over and stop the vehicle immediately, paying attention to road and traffic conditions. In such cases, consult a qualified specialist workshop.

The multimedia device is equipped with technical provisions to protect it against theft. Further information is available from any smart center.

The functionality of a roof antenna (radio, DAB) may be impaired if roof carriers are used. Metallized retrofit film on windows may also affect radio and GPS reception and have a negative impact on all other antenna functions in the vehicle interior.

Declarations of conformity

Vehicle components which receive and/or transmit radio waves

USA: "The wireless devices of this vehicle comply with Part 15 of the FCC Rules. Operation is subject to the following two conditions: 1) These devices may not cause harmful interference, and 2) These devices must accept any interference received, including interference that may cause undesired operation. Changes or modifications not expressly approved by the party responsible for compliance could void the user's authority to operate the equipment."

Canada: "The wireless devices of this vehicle comply with Industry Canada license-exempt RSS standard(s). Operation is subject to the following two conditions: (1) These devices may not cause interference, and (2) These devices must accept any interference, including interference that may cause undesired operation of the device."

Diagnostics connection

The diagnostics connection is only intended for the connection of diagnostic equipment at a qualified specialist workshop.

WARNING

If you connect equipment to a diagnostics connection in the vehicle, it may affect the operation of vehicle systems. As a result, the operating safety of the vehicle could be affected. There is a risk of an accident.

Only connect equipment to a diagnostics connection in the vehicle, which is approved for your vehicle by Mercedes-Benz.

WARNING

Objects in the driver's footwell can restrict the pedal travel or obstruct a depressed pedal. The operating and road safety of the vehicle is jeopardized. There is a risk of an accident.

Make sure that all objects in the vehicle are stowed correctly, and that they cannot

enter the driver's footwell. Install the floor mats securely and as specified in order to ensure sufficient clearance for the pedals. Do not use loose floor mats and do not place floor mats on top of one another.

I If the engine is switched off and a device which is connected to the on-board diagnostics connection is being used, the battery may discharge.

Qualified specialist workshop

A smart center is a qualified specialist workshop. It has the necessary specialist knowledge, tools and qualifications to correctly carry out the work required on your vehicle. This is especially the case for work relevant to safety.

Observe the information contained in the Maintenance Booklet.

Always have the following work carried out on your vehicle at a smart center:

- work relevant to safety
- service and maintenance work
- repair work
- alterations, installation work and modifications
- work on electronic components

High-voltage electrical system

Danger of electric shock

DANGER

The vehicle's high-voltage electrical system is under high voltage. If you modify components in the vehicle's high-voltage electrical system or touch damaged components, you may be electrocuted. The components in the vehicle's high-voltage electrical system may be damaged in an accident, although the damage is not visible. There is a risk of fatal injury.

Following an accident, do not touch any high-voltage components and never modify the vehicle's high-voltage electrical system. Have the vehicle towed away after

an accident and the vehicle's high-voltage electrical system checked by a qualified specialist workshop.



All of the vehicle's high-voltage electrical system components are marked with yellow warning stickers which warn you of the dangers of high voltages. The cables of the vehicle's high-voltage electrical system are orange in color.

Observe the following before carrying out general work such as changing a bulb or checking the coolant level:

- the ignition is switched off
- the charging cable for charging the high-voltage battery is disconnected

Automatically switching off the vehicle's high-voltage electrical system

In order to prevent anyone coming into contact with high voltage, the high-voltage electrical system is generally switched off automatically in the following cases:

- the restraint systems are activated in the event of an accident
- an electrical short circuit is detected in the vehicle's high-voltage electrical system
- an electrical connection in the vehicle's high-voltage electrical system is disconnected

High-voltage battery

WARNING

In the event of a vehicle fire, the internal pressure of the high-voltage battery can exceed a critical value. In this case flammable gas escapes through a ventilation

valve on the underbody. The gas can ignite. There is a risk of injury.

Leave the danger zone immediately. Secure the danger area at a suitable distance, whilst observing legal requirements.

WARNING

If the housing of the high-voltage battery has been damaged, electrolyte and gases may leak out. These are poisonous and caustic. There is a risk of injury.

Avoid contact with skin, eyes or clothing. Immediately rinse electrolyte splashes off with water and seek medical attention straight away.

Correct use

If warning stickers are removed, you may fail to recognize certain dangers. Leave warning stickers in place.

The following are important sources of information in regard to vehicle use:

- safety notes in this Operator's Manual
- technical data in this Operator's Manual
- traffic rules and regulations
- laws and safety standards pertaining to motor vehicles

Problems with your vehicle

If you should experience a problem with your vehicle, particularly one that you believe may affect its safe operation, we urge you to immediately contact an authorized smart center to have the problem diagnosed and corrected if required. Do not drive the vehicle if you believe it may not be safely operated. If the matter is not handled to your satisfaction, please discuss the problem with the smart center management, or if necessary contact us at one of the following addresses:

In the USA

Mercedes-Benz USA, LLC
Three Mercedes Drive
Montvale, NJ 07645

In Canada

Customer Relations Department
98 Vanderhoof Avenue
Mercedes-Benz Canada, Inc.
Toronto, Ontario M4G 4C9

QR codes for rescue card

QR codes are on the socket flap and on the door pillar (B-pillar) on the opposite side. In the event of an accident, rescue services can use the QR code to quickly determine the corresponding rescue card for a vehicle. The current rescue card contains the most important information about the vehicle in compact form, such as the routing of the electric cables. Further information: www.mercedes-benz.de/qrcode

Data stored in the vehicle

Data recording

A large number of your vehicle's electronic components can store data.

The data memory temporarily or permanently stores technical information about:

- Vehicle's operating status
- Incidents
- Malfunctions

The technical information generally documents the condition of a component, module, system or the environment.

These include, for example:

- Operating status of system components, e.g. fluid levels
- Status messages concerning the vehicle and its individual components, e.g. number of wheel revolutions/speed, deceleration in movement, lateral acceleration, accelerator pedal position
- Malfunctions and defects in key system components, including, for instance, lights, brakes
- Vehicle reactions and operating conditions in special driving situations, including, for instance, deployment of an air bag, use of stability control systems
- Environmental conditions, including, for instance, the outside temperature

This data is of an exclusively technical nature and can be used to:

- assist in the detection and elimination of malfunctions and defects
- analyze vehicle functions, e.g. after an accident
- optimize vehicle functions

The data cannot be used to trace the vehicle's movements.

If you have the vehicle serviced, this technical information can be read out from the event and malfunction data memory.

Services include, for example, information on:

- Repair work
- Service work
- Warranty claims
- Quality assurance

The readout is handled by service network staff (including the manufacturer) with the help of special diagnostic testers. You can obtain more detailed information, if required.

After the malfunction has been rectified, the information is cleared in the malfunction memory or is sequentially overwritten.

During vehicle operation, certain situations may arise in which this technical data – in conjunction with other information and, if applicable, after consultation with an approved assessor – may be linked to an individual person.

Examples of this include:

- Accident reports
- Vehicle damage
- Evidence

Event data recorders

This vehicle is equipped with an event data recorder (EDR). The main purpose of an EDR is to record data that will assist in understanding how a vehicle's systems performed in certain crash or near crash-like situations, such as during air bag deployment or when hitting a road obstacle. The EDR is designed to record data related to vehicle dynamics and safety systems for a short period of time, typically 30 seconds or less.

The EDR in this vehicle is designed to record such data as:

- how various systems in your vehicle are operating
- whether or not the driver and passenger seat belts are fastened
- how far (if at all) the driver is depressing the accelerator and/or brake pedal and
- how fast the vehicle is traveling

This data can help provide a better understanding of the circumstances in which crashes and injuries occur. NOTE: EDR data is recorded by your vehicle only if a nontrivial crash situation occurs. No data is recorded by the EDR under normal driving conditions. No personal data (e.g., name, gender, age, and accident location) are recorded. However, other parties, such as law enforcement, can combine the EDR data with the type of personal identification data routinely acquired during a crash investigation. EDR data may be used in civil and criminal matters as a tool in accident reconstruction, accident claims, and vehicle safety.

To read data recorded by an EDR, special equipment is required, and access to the vehicle or the EDR is needed. In addition to the vehicle manufacturer, other parties that have the special equipment, such as law enforcement, can read the information by accessing the vehicle or the EDR.

EDR data may be used in civil and criminal matters as a tool in accident reconstruction, accident claims, and vehicle safety. Since the Crash Data Retrieval CDR tool that is used to extract data from the EDR is commercially available, Mercedes-Benz USA, LLC ("MBUSA") expressly disclaims any and all liability arising from the extraction of this information by unauthorized Mercedes-Benz personnel.

MBUSA will not share EDR data with others without the consent of the vehicle owners or, if the vehicle is leased, without the consent of the lessee. Exceptions to this representation include responses to subpoenas by law enforcement; by federal, state or local government; in connection with or arising out of litigation involving MBUSA or its subsidiaries and affiliates; or, as required by law.

Warning: the EDR is a component of the Restraint System Module. Tampering with, altering, modifying or removing the EDR

component may result in a malfunction of the Restraint System Module and other systems.

State laws or regulations regarding EDRs that conflict with federal regulation are pre-empted. This means that in the event of such conflict, the federal regulation governs. As of February 2013, 13 states have enacted laws related to EDRs.

Information on copyright

Information on licenses of Free and Open-Source software used in the vehicle and the electronic components:

<http://www.mercedes-benz.com/opensource>

Dashboard

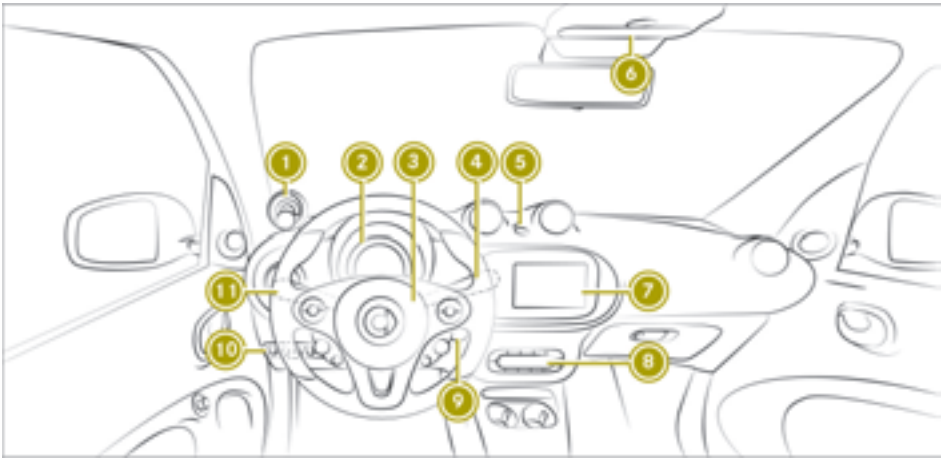

>> At a glance.

	Function	Page		Function	Page
①	Charge level display	57	⑧	Climate control system control panel	77
	Power display	57	⑨	Ignition lock	52
②	Instrument cluster	32	⑩	Control panel for: Tailgate release	45
③	Horn			Forward collision warning	
④	Windshield wipers combination switch	70		Acoustic presence indicator	55
⑤	Automatic locking feature	72	⑪	Lights combination switch	68
	Hazard warning lamps	149			
⑥	Overhead control panel	30			
⑦	smart Audio-System	87			
	smart Media-System	94			

Multifunction steering wheel

>> At a glance.

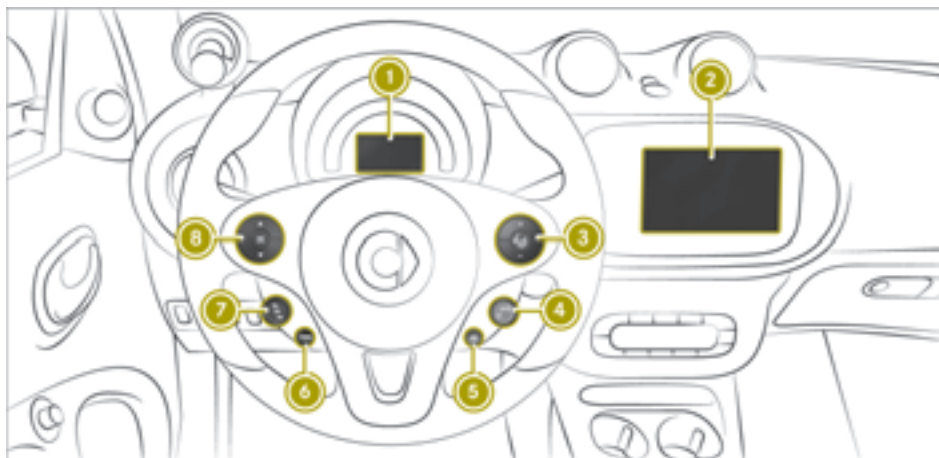

	Function	Page
①	Color display of the instrument cluster	83
②	smart Audio-System smart Media-System	87 94
③	Adjusts the volume Switches voice-operated control on or off and accepts or ends a call	94 94
④	Increases or stores the current speed - Decreases current speed	61 61
⑤	Calls up the last speed stored	61

	Function	Page
⑥	Interrupts cruise control	61
⑦	Cruise control button Activates cruise control Deactivates cruise control	61 61
⑧	Scrolls through menus Confirms the selection	83 85

Center console with drawer

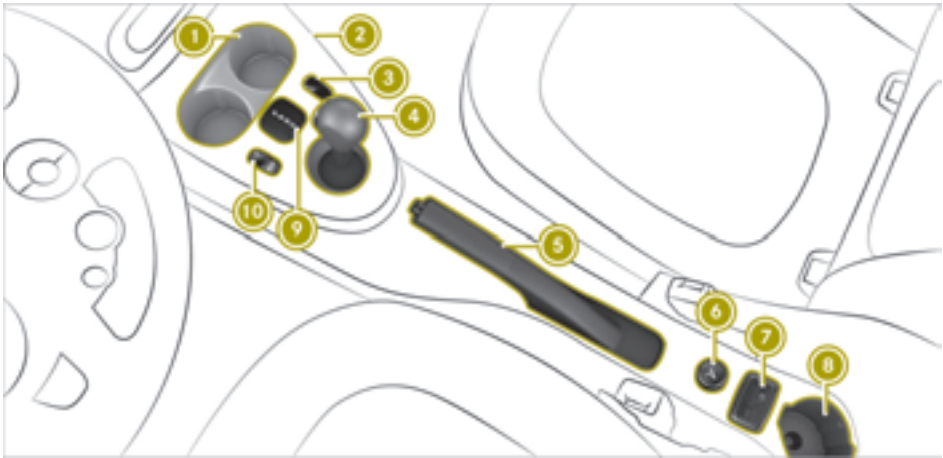

>> At a glance.

	Function	Page		Function	Page
①	Cup holder Ashtray	116 80	⑥	Cigarette lighter Socket	79 80
②	Drawer	116	⑦	smart Media-System: AUX port, USB port and SD card slot	94
③	smart fortwo coupe: coin holder		⑧	Cup holder	116
③	smart fortwo cabrio: opens and closes the soft top	73	⑨	Selector lever indicator	54
④	Selector lever	55	⑩	ECO mode	56
⑤	Parking brake	53			

Overhead control panel

>> At a glance.

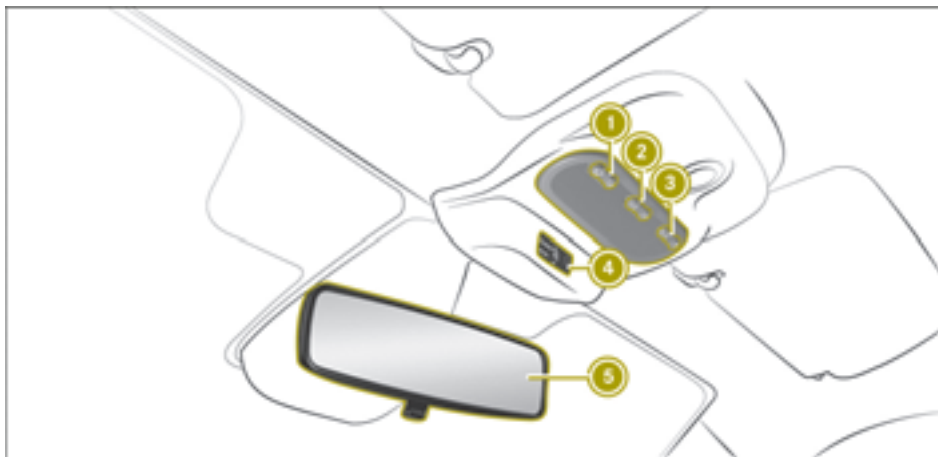

	Function	Page
①	Left-hand reading lamp	69
②	Interior lighting	69
③	Right-hand reading lamp	69

	Function	Page
④	PASSENGER AIRBAG indicator lamps	39
⑤	Rear-view mirror	50

Door control panel

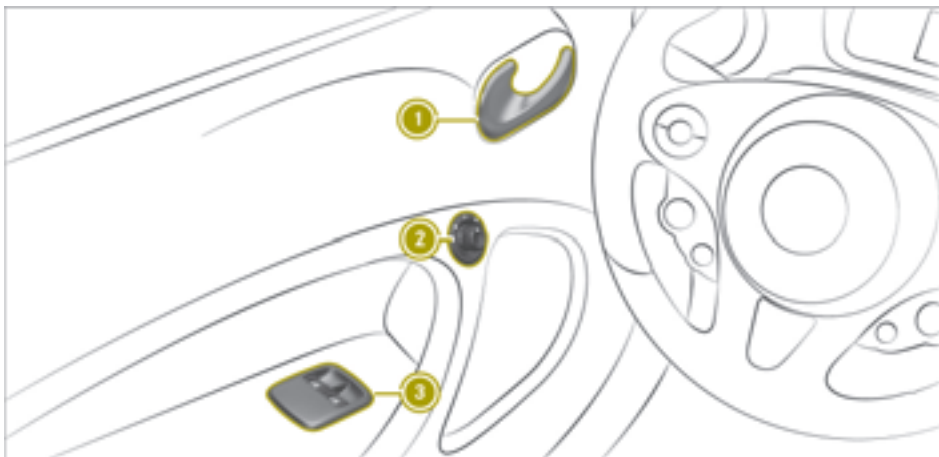

	Function	Page
①	Opens the door	72
②	Adjusts the exterior mirrors	50

	Function	Page
③	Opens and closes the side windows	73

Displays shown in the instrument cluster and the display

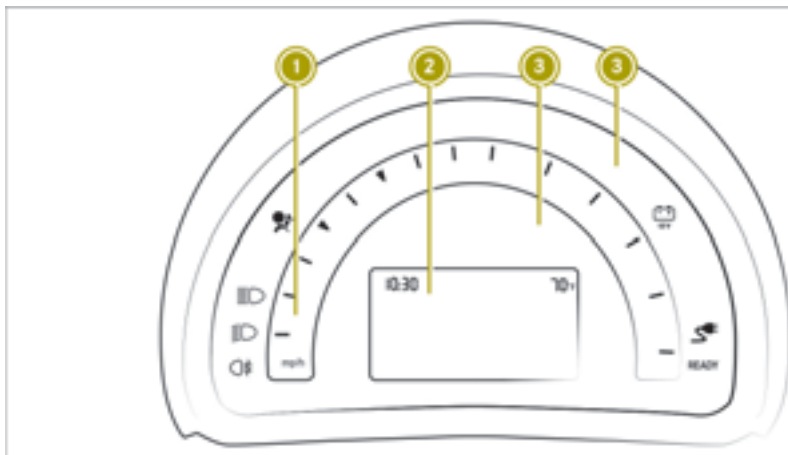

>> At a glance.



	Function	Page
①	Speedometer	
②	Display	
③	Warning and indicator lamps	
	Doors or tailgate	162
	Seat belts	163
	Restraint system	164
	Drive diagnostics	167
	USA: brakes	166
	Canada: brakes	166
	USA: ABS	170
	Canada: ABS	170
	ESP®	46
	Tire pressure monitor	172

	Function	Page
	Distance warning signal	175
	Forward collision warning	175
	12 V battery	176
	Rear fog lamp	69
	Front fog lamps	69
	High-beam headlamps	68
	Low-beam headlamps	68
	Parking lamps	69
	Charging cable	167
	Cruise control	176
	Next service due date	
	READY indicator	176

Activating and deactivating the panic alarm

- ▶ To activate: press the  button on the SmartKey for about two seconds. An alarm sounds and the exterior lighting flashes.
- ▶ To deactivate: press the  button on the SmartKey.

Occupant safety

Restraint system

Protection provided by the restraint system

The restraint system includes the:

- Seat belt system
- Air bags

In an accident the restraint system can:

- reduce the risk of vehicle occupants coming into contact with parts of the vehicle interior
- reduce the forces to which vehicle occupants are subjected

A seat belt can only provide maximum protection when worn correctly. Depending on the type of accident detected, Emergency Tensioning Devices and/or air bags may supplement a correctly worn seat belt. Not every accident will trigger the Emergency Tensioning Devices and/or deploy the air bags. To ensure that the restraint system provides the maximum protection, every vehicle occupant must:

- have the seat belt fastened correctly
- sit in a position that is as upright as possible with the back against the seat backrest
- have their feet resting on the floor, if possible
- always be secured in special additional restraint systems suitable for your vehicle if under 5 ft (1.50 m) tall

However, no system available today can completely eliminate injuries and fatalities in every accident. In particular, the seat belt and air bag generally do not protect against objects penetrating the vehicle from the out-

side. The risk of injuries due to a deployed air bag also cannot be completely eliminated.

Limited protection from restraint system

WARNING

Modifications to the restraint system may cause it to no longer work as intended. The restraint system may then not perform its intended protective function and may fail in an accident or trigger unexpectedly, for example. This poses an increased risk of injury or even fatal injury.

Never modify parts of the restraint system. Never tamper with the wiring, the electronic components or their software.



If the vehicle needs to be adjusted to accommodate a person with disabilities, contact a qualified specialist workshop. smart recommends that you only use driving assistance systems which have been approved for your vehicle by smart.

Contact a smart center for details. USA only: contact our Customer Assistance Center on 1-800-762-7887 for more details.

Preparing the restraint system for operation

When the ignition is switched on, the  restraint system warning lamp lights up during the system self-test. It goes out no later than a few seconds after the vehicle is started. The components of the restraint system are then ready for operation.

Restraint system malfunctions

- When the ignition is switched on, the  restraint system warning lamp does not light up.
- While driving, the  restraint system warning lamp remains lit or lights up repeatedly.

If the restraint system is malfunctioning, the vehicle's high-voltage electrical system may also not be deactivated as intended in the event of an accident.

DANGER

If the restraint system is malfunctioning, restraint system components may be triggered unintentionally or may not deploy as intended during an accident. This can affect for example the Emergency Tensioning Device or the air bag. Furthermore, in the event of an accident, the vehicle's high-voltage electrical system may not be deactivated as intended. You may be electrocuted if you touch the damaged components of the vehicle's high-voltage electrical system. This poses an increased risk of injury or even fatal injury.

Have the restraint system checked and repaired in a qualified specialist workshop as soon as possible. After an accident, switch off the ignition immediately and remove the key from the ignition lock.

Restraint system response during an accident

The way the restraint system responds depends on the severity of the impact detected and the apparent type of accident:

- Head-on collision
- Rear impact
- Side impact
- Rollover

The activation threshold for the restraint system components is determined based on the analysis of the sensor values measured at various points in the vehicle. This process is pre-emptive in nature. The triggering process of the restraint system components should take place in good time at the start of the collision.

Factors which can only be seen and measured after a collision has occurred do not play a decisive role in the deployment of an air bag, nor do they provide an indication of air bag deployment.

The vehicle may be deformed significantly without an air bag being deployed. This is the case if only parts which are relatively easily deformed are affected and the rate of

vehicle deceleration is not high. Conversely, an air bag may be deployed even though the vehicle suffers only minor deformation. If, for instance, very rigid vehicle parts such as longitudinal body members are hit, the rate of vehicle deceleration may be sufficient.

The restraint system components can be activated or triggered independently of each other:

Component	Detected trigger situation
Emergency Tensioning Device (ETD) for seat belts	Head-on collision, rear impact, side impact, rollover
Driver's air bag, front-passenger front air bag and knee bag	Head-on collision
Side impact air bag	Side impact
Windowbag ¹ or headbag ²	Side impact, rollover, head-on collision

The front-passenger front air bag can only be deployed in an accident if the PASSENGER AIR BAG ON indicator lamp is lit. If the front-passenger seat is occupied, make sure that the status of the front-passenger front air bag is correct both before and during the journey (▷ page 39).

WARNING

The air bag parts are hot after an air bag has been deployed. There is a risk of injury. Do not touch the air bag parts. Have a deployed air bag replaced at a qualified specialist workshop as soon as possible.

- i** smart recommends that you have the vehicle towed to a qualified specialist workshop after an accident. Take this into account, particularly if an Emergency Tensioning Device was triggered or an air bag was deployed.

¹ smart fortwo coupe

² smart fortwo cabrio

If the Emergency Tensioning Devices are triggered or an air bag is deployed, you will hear a bang, and a small amount of powder may also be released:

- The bang will not usually affect your hearing.
- In general, the powder released is not hazardous to health but may cause short-term breathing difficulties to persons suffering from asthma or other pulmonary conditions.

Provided it is safe to do so, leave the vehicle immediately or open the window in order to prevent breathing difficulties.

Air bags and pyrotechnic Emergency Tensioning Devices contain perchlorate material, which may require special handling and environmental protection measures. National guidelines must be observed during disposal. In California, see www.dtsc.ca.gov/HazardousWaste/Perchlorate/index.cfm.

Seat belts

Protection provided by seat belts

Always fasten seat belts correctly before starting your journey. A seat belt can only provide maximum protection when worn correctly.

WARNING

If the seat belt is not worn correctly, it cannot perform its intended protective function. An incorrectly fastened seat belt can also cause injuries, for example, in the event of an accident or when braking or changing direction abruptly. This poses an increased risk of injury or even fatal injury.

Always ensure that all vehicle occupants have their seat belts fastened correctly and are sitting properly.

- The seat belt must:
 - not be twisted and must be tight and fit snugly across your body
 - be routed across the center of the shoulder and as low down across your hips as possible
- The shoulder section of the seat belt should not touch your neck nor be routed under your arm or behind your back.
- Avoid wearing bulky clothing, e.g. a winter coat.
- Press the lap belt down into your hip joints and pull tight by the shoulder section of the belt. The lap belt must never be routed across your stomach or abdomen.
- Never route the seat belt across sharp, pointed, abrasive or fragile objects.
- Only one person per seat belt. Infants and children must never travel sitting on the lap of a vehicle occupant.
- Never secure objects with a seat belt if the seat belt is also being used by one of the vehicle's occupants. Always observe the notes on "Loading the vehicle" for securing objects, luggage or loads (▷ page 117).

The front-passenger seat belt is equipped with a special seat belt retractor. Further information can be found under "Special seat belt retractor" (▷ page 43).

If children are traveling in the vehicle, be sure to observe the instructions and safety notes on "Children in the vehicle" (▷ page 42).

Limited protection from seat belts

WARNING

The seat belt does not offer the intended level of protection if you have not moved the backrest to an almost vertical position. When braking or in the event of an accident, you could slide underneath the seat belt and sustain abdomen or neck injuries, for example. This poses an increased risk of injury or even fatal injury.

Adjust the seat properly before beginning your journey. Always ensure that the backrest is in an almost vertical position and that the shoulder section of your seat

belt is routed across the center of your shoulder.

WARNING

Persons less than 5 ft (1.50 m) tall cannot wear the seat belt correctly without an additional and suitable restraint system. If the seat belt is not worn correctly, it cannot perform its intended protective function. An incorrectly fastened seat belt can also cause injuries, for example, in the event of an accident or when braking or changing direction abruptly. This poses an increased risk of injury or even fatal injury.

For this reason, always secure persons under 5 ft (1.50 m) tall in suitable additional restraint systems.

WARNING

If objects between the seat and door are blocking the moving belt anchorage on the seat, this restricts the restraining effect of the seat belt. The seat belt can no longer protect as intended. This poses an increased risk of injury or even fatal injury.

Make sure that no objects are between the seat and door before beginning a journey.

WARNING

The seat belts may not perform their intended protective function if:

- they are damaged, modified, extremely dirty, bleached or dyed
- the seat belt buckle is damaged or extremely dirty
- the Emergency Tensioning Devices, belt anchorages or inertia reels have been modified.

Seat belts may be damaged in an accident, although the damage may not be visible, e.g. due to splinters of glass. Modified or damaged seat belts may tear or fail, e.g. in an accident. Modified Emergency Tensioning Devices could accidentally trigger or

fail to deploy when necessary. This poses an increased risk of injury or even fatal injury.

Never modify the seat belts, Emergency Tensioning Devices, belt anchorages and inertia reels. Make sure that the seat belts are undamaged, not worn out and clean. Following an accident, have the seat belts checked immediately at a qualified specialist workshop.

Only use seat belts which have been approved specifically for your vehicle by smart.

WARNING

Emergency Tensioning Devices that have deployed pyrotechnically are no longer operational and are unable to perform their intended protective function. This poses an increased risk of injury or even fatal injury.

Have pyrotechnically triggered Emergency Tensioning Devices replaced immediately at a qualified specialist workshop.

smart recommends that you have the vehicle towed to a qualified specialist workshop after an accident.

- ❗ Make sure that the seat belt is fully rolled up. Otherwise, the seat belt or belt tongue will be trapped in the door or in the seat mechanism. This could damage the door, the door trim panel and the seat belt. Damaged seat belts can no longer fulfill their protective function and must be replaced. Visit a qualified specialist workshop.

Fastening and releasing the seat belt

If the seat belt is pulled out quickly or sharply, the inertia reel locks. The belt strap cannot be pulled out any further.

- ❗ If the front-passenger seat is unoccupied, do not insert the belt tongue into the buckle of the front-passenger seat. This may otherwise lead to the triggering of the Emergency Tensioning Device in the event of an accident, which will then need to be replaced.

For easy fastening, the seat belt is guided through the seat belt guide on the side of the seat.



- ① Buckle
- ② Seat belt tongue

- ▶ **To fasten:** always engage seat belt tongue ② into buckle ① of the corresponding seat.
- ▶ **To release:** press the release button in belt buckle ① and guide the seat belt back by belt tongue ②.

Belt warning for the driver and front-passenger

The  seat belt warning lamp in the instrument display is a reminder that all vehicle occupants must wear their seat belts correctly.

After each start, the  seat belt warning lamp flashes for six seconds.

In addition, there may be a warning tone.

The belt warning goes out as soon as the doors are closed and the driver and front-passenger fasten their seat belts.

The belt warning comes on:

- if the vehicle exceeds a speed of 12 mph (20 km/h) once and neither the driver nor the front passenger have fastened their seat belt
- if the driver or front-passenger unfasten their seat belt while the vehicle is moving

³ smart fortwo cabrio

⁴ smart fortwo coupe

Air bags

Overview of air bags

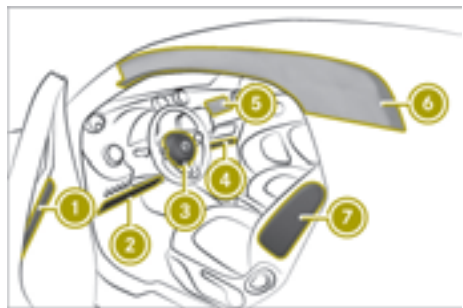

The installation location of an air bag is identified by the AIRBAG symbol.

A deployed air bag can increase the level of protection provided to the vehicle occupant.

	Air bag	Possible protection for:
①	Headbag ³	Head
②	Driver's knee bag	Thigh, knee and lower leg
③	Driver's air bag	Head and thorax
④	Front-passenger knee bag	Thigh, knee and lower leg
⑤	Front-passenger front air bag	Head and thorax
⑥	Windowbag ⁴	Head
⑦	Side impact air bag	Thorax and pelvis

The front-passenger front air bag can only be deployed in an accident if the PASSENGER AIR BAG ON indicator lamp is lit. If the front-passenger seat is occupied, make sure that the status of the front-passenger front air bag is correct both before and during the journey (> page 39).

Protection provided by the air bags

Depending on the type of accident, an air bag can supplement a correctly worn seat belt and provide added protection.

WARNING

If you do not sit in the correct seat position, the air bag cannot protect as intended and could even cause additional injury when deployed. This poses an increased risk of injury or even fatal injury.

To avoid hazardous situations, always make sure that all of the vehicle's occupants:

- have fastened their seat belts correctly, including pregnant women
- are sitting correctly and maintain the greatest possible distance to the air bags
- follow the following instructions

Always make sure that there are no objects between the air bag and the vehicle's occupants.

To avoid risks as a result of a deployed air bag:

- Adjust seats correctly before starting your journey and move the driver's and front-passenger seat as far back as possible. Always observe the information on the correct driver's seat position (▷ page 48).
- Only hold onto the outside of the steering wheel rim. This allows the air bag to be fully deployed.
- Always lean against the backrest while driving. Do not lean forwards or lean against the door or side window. You may otherwise be in the deployment area of the air bags.
- Always keep your feet on the floor. Do not put your feet on the dashboard, for example. Your feet may otherwise be in the deployment area of the air bag.
- When children are traveling in the vehicle, follow the related additional notes (▷ page 42).
- Always properly stow and secure objects.

Objects in the vehicle interior may limit an air bag's ability to function correctly. Therefore, always make sure that:

- There are no people, animals or objects between the vehicle occupants and an air bag.
- There are no objects between the seat, the door and the door pillar (B-pillar).
- No hard objects, e.g. coat hangers, are hanging on the grab handles or coat hooks.
- No accessories, such as cup holders, are attached within the deployment area of an airbag, e.g. to doors, side windows or side trim panels.
- No heavy, sharp-edged or fragile objects are kept in the pockets of clothing. Store such objects in a suitable place.

Limited protection from air bags

WARNING

If you modify the air bag cover or affix objects such as stickers to it, the air bag can no longer function correctly. There is an increased risk of injury.

Never modify an air bag cover or affix objects to it.

WARNING

Unsuitable seat covers can obstruct or even prevent the deployment of the air bags integrated in the seats. Consequently, the air bags cannot protect vehicle occupants as intended. In addition, the operation of the automatic front-passenger front air bag deactivation system could be restricted. This poses an increased risk of injury or even fatal injury.

Only use seat covers that have been approved for the corresponding seats by smart.

WARNING

Sensors to control the air bags are located in the doors. Modifications or work not performed correctly to the doors or door paneling, as well as damaged doors, can lead to

the function of the sensors being impaired. The air bags might therefore not function properly anymore. Consequently, the air bags cannot protect vehicle occupants as they are designed to do. There is an increased risk of injury.

Never modify the doors or parts of the doors. Always have work on the doors or door paneling carried out at a qualified specialist workshop.

WARNING

A deployed air bag no longer offers any protection and cannot provide the intended protection in an accident. There is an increased risk of injury.

Have the vehicle towed to a qualified specialist workshop in order to have a deployed air bag replaced.

Have deployed air bags replaced immediately.

Status of the front-passenger front air bag

Important notes when the front-passenger seat is occupied

The automatic front-passenger air bag deactivation system can detect if there is a person or a child restraint system on the front-passenger seat. The front-passenger air bag is enabled or disabled accordingly.

When installing a child restraint system on the front-passenger seat:

- ensure that the child restraint system is positioned correctly (▷ page 42)
- always comply with the child restraint system manufacturer's installation instructions
- never place objects, such as cushions, under or behind the child restraint system
- the base of the child restraint system must lie fully against the seat cushion of the front-passenger seat

- the back of a forward-facing child restraint system must lie as flat as possible against the front-passenger backrest
- the child restraint system must not touch the roof. Adjust the angle of the seat backrest accordingly

WARNING

Objects between the seat surface and the child restraint system could affect the function of the automatic front-passenger front air bag deactivation system. This could result in the front-passenger air bag not functioning as intended during an accident. This poses an increased risk of injury or even fatal injury.

Do not place any objects between the seat surface and the child restraint system. The entire base of the child restraint system must always rest on the seat cushion of the front-passenger seat. The backrest of the forwardfacing child restraint system must, as far as possible, be resting on the backrest of the front-passenger seat. Always comply with the child restraint system manufacturer's installation instructions.

A person on the front-passenger seat must:

- have the seat belt fastened correctly
- sit in a position that is as upright as possible with the back against the seat backrest
- have their feet resting on the floor, if possible

Otherwise the front-passenger air bag can be disabled by mistake, for instance because the front-passenger:

- has transferred their weight by leaning on the armrests in the vehicle
- sits in such a way that the weight on the seat cushion is reduced

WARNING

If the PASSENGER AIR BAG OFF indicator lamp is lit, the front-passenger front air bag is disabled. It will not be deployed in the event of an accident and cannot perform its intended protective function. A

person in the front-passenger seat could then, for example, come into contact with the vehicle's interior, especially if the person is sitting too close to the dashboard. This poses an increased risk of injury or even fatal injury.

When the front-passenger seat is occupied, always ensure that:

- the classification of the person in the front-passenger seat is correct and the front-passenger front air bag is enabled or disabled in accordance with the person in the front-passenger seat
- the front-passenger seat has been moved back as far back as possible.
- the person is seated correctly.

Make sure, both before and during the journey, that the status of the front-passenger front air bag is correct.

PASSENGER AIR BAG indicator lamps

System self-test



When the ignition is switched on, both PASSENGER AIR BAG ON and OFF indicator lamps light up at the same time during the system self-test.

The indicator lamps then display the status of the front-passenger front air bag:

- PASSENGER AIR BAG ON lights up: the front-passenger front air bag is enabled. If, in the case of an accident, all deployment criteria are met, the front-passenger front air bag is deployed.
- PASSENGER AIR BAG OFF lights up: the front-passenger front air bag is disabled.

It will then not be deployed in the event of an accident.

If the PASSENGER AIR BAG OFF indicator lamp and restraint system warning lamp  light up at the same time, the front-passenger seat may not be used. In this case, do not install a child restraint system on the front-passenger seat. Have the automatic front-passenger air bag deactivation system checked and repaired immediately at a qualified specialist workshop.

Status indicator

If the front-passenger seat is occupied, make sure that the status of the front-passenger front air bag is correct for the prevailing conditions both before and during the journey.

After installing a rearward-facing child restraint system on the front-passenger seat:

PASSENGER AIR BAG OFF must be lit continuously.

WARNING

If you secure a child in a rearward-facing child restraint system on the front-passenger seat and the PASSENGER AIR BAG ON indicator lamp is lit up, the front-passenger front air bag may deploy in an accident. The child could be struck by the air bag. This poses an increased risk of injury or even fatal injury.

Make sure that the front-passenger front air bag has been deactivated. The PASSENGER AIR BAG OFF indicator lamp must be lit.

NEVER use a rearward-facing child restraint on a seat protected by an ACTIVE FRONT AIR BAG in front of it; DEATH or SERIOUS INJURY to the child can occur.

Observe the vehicle-specific notes when installing a child restraint system on the front-passenger seat (▷ page 42).

The PASSENGER AIR BAG ON indicator lamp may light up, depending on the child restraint system and the size of the child. In this case, do not install the rearward-facing

child restraint system on the front-passenger seat.

After installing a forward-facing child restraint system on the front-passenger seat:

PASSENGER AIR BAG OFF or PASSENGER AIR BAG ON may be lit continuously, depending on the child restraint system and the child's stature. Always observe the following notes:

 **WARNING**

If you secure a child in a forward-facing child restraint system on the front-passenger seat and you position the front-passenger seat too close to the dashboard, in the event of an accident, the child could:

- come into contact with the vehicle's interior if the PASSENGER AIR BAG OFF indicator lamp is lit, for example
- be struck by the air bag if the PASSENGER AIR BAG ON is lit up

This poses an increased risk of injury or even fatal injury.

Move the front-passenger seat as far back as possible. Always make sure that the shoulder belt strap is correctly routed from the vehicle belt guide to the shoulder belt guide on the child restraint system. The shoulder belt strap must be routed forwards and downwards from the belt guide. Always observe the child restraint system manufacturer's installation instructions.

Observe the vehicle-specific notes when installing a child restraint system on the front-passenger seat (▷ page 42).

If a person is sitting on the front-passenger seat:

PASSENGER AIR BAG OFF or PASSENGER AIR BAG ON may be lit continuously, depending on the person's stature. Always observe the following notes:

If the front-passenger seat is occupied by:

- an adult or a person of corresponding stature, the PASSENGER AIR BAG ON indicator lamp must be lit continuously. This indicates that the front-passenger air bag is enabled
 - If the PASSENGER AIR BAG OFF lights up continuously, the front-passenger seat must not be used by an adult or person of corresponding stature.
- a person of smaller stature (e.g. a teenager or small adult), either the PASSENGER AIR BAG OFF or PASSENGER AIR BAG ON lamp lights up continuously, depending on the Occupant Classification System result
 - PASSENGER AIRBAG ON is lit continuously: move the front-passenger seat as far back as possible
 - PASSENGER AIRBAG OFF is lit continuously: the front-passenger seat must not be used by a person of small stature

 **WARNING**

If the PASSENGER AIRBAG OFF indicator lamp remains lit after the system self-test, the front-passenger front air bag is disabled. It will not be deployed in the event of an accident. In this case, the front-passenger front air bag cannot perform its intended protective function, e.g. when a person is seated in the front-passenger seat.

That person could, for example, come into contact with parts of the vehicle's interior, especially if the person is sitting too close to the dashboard. This poses an increased risk of injury or even fatal injury.

When the front-passenger seat is occupied, always ensure that:

- the classification of the person in the front-passenger seat is correct and the front-passenger front air bag is enabled or disabled in accordance with the person in the front-passenger seat
- the person is seated properly with a correctly fastened seat belt
- the front-passenger seat has been moved as far back as possible

If children are traveling in the vehicle, be sure to observe the notes on "Children in the vehicle" (▷ page 42).

Children in the vehicle

Traveling safely with children on board

WARNING

If you leave children unsupervised in the vehicle, they could set it in motion by, for example:

- release the parking brake.
- shift the automatic transmission out of the parking position **P**.
- start the engine.

In addition, they may operate vehicle equipment and become trapped. There is a risk of an accident and injury.

When leaving the vehicle, always take the SmartKey with you and lock the vehicle. Never leave children unsupervised in the vehicle.

WARNING

If persons, particularly children are subjected to prolonged exposure to extreme heat or cold, there is a risk of injury, possibly even fatal. Never leave children unattended in the vehicle.

WARNING

If the child restraint system is subjected to direct sunlight, parts may get very hot. Children may burn themselves on these parts, particularly on the metal parts of the child restraint system. There is a risk of injury.

If you leave the vehicle, taking the child with you, always ensure that the child restraint system is not exposed to direct sunlight. Protect it with a blanket, for example. If the child restraint system has been exposed to direct sunlight, let it cool down before securing the child in it. Never leave children unattended in the vehicle.

The use of seat belts and child restraint systems is required by law in:

- all 50 states
- the U.S. territories
- the District of Columbia
- all Canadian provinces

All child restraint systems must meet the following standards:

- U.S. Federal Motor Vehicle Safety Standards 213 and 225
- Canadian Motor Vehicle Safety Standards 213 and 210.2

You can obtain further information about the correct child restraint system from any smart center.

To provide better protection to children younger than 12 years old and under 5 ft (1.50 m) tall, smart recommends always observing the following:

- Secure children only in a child restraint system that is appropriate for the age, weight and size of the child and that is recommended and suitable for use in smart vehicles. Make sure you observe the instructions for correct use of the child restraint system.
- Only use the following securing systems with the child restraint systems:
 - the seat belt system
 - the Top Tether anchorages
- The manufacturer's child restraint system installation instructions.
- The warning labels in the vehicle interior and on the child restraint system.

WARNING

If the child restraint system is installed incorrectly on a suitable seat, it cannot protect as intended. The child cannot then be restrained in the event of an accident, heavy braking or sudden changes of direction. There is an increased risk of injury, possibly even fatal.

Make sure that you observe the child restraint system manufacturer's installation instructions and the notes on use. Please ensure, that the base of the child restraint system is always resting completely on the seat cushion. Never place

objects, e.g. cushions, under or behind the child restraint system. Only use child restraint systems with the original cover designed for them. Only replace damaged covers with genuine covers.

 **WARNING**

If the child restraint system is installed incorrectly or is not secured, it can come loose in the event of an accident, heavy braking or a sudden change in direction. The child restraint system could be thrown about, striking vehicle occupants. There is an increased risk of injury, possibly even fatal.

Always install child restraint systems properly, even if they are not being used. Make sure that you observe the child restraint system manufacturer's installation instructions.

 **WARNING**

Child restraint systems or their securing systems which have been damaged or subjected to a load in an accident can no longer protect as intended. The child cannot then be restrained in the event of an accident, heavy braking or sudden changes of direction. There is an increased risk of injury, possibly even fatal.

Replace child restraint systems which have been damaged or subjected to a load in an accident as soon as possible. Have the securing systems on the child restraint system checked at a qualified specialist workshop, before you install a child restraint system again.

A booster seat may be necessary to achieve proper seat belt positioning for children over 41 lbs (18 kg) or until they reach a height where a three-point seat belt can be properly fastened without a booster seat.

Also, always observe the detailed information below:

- When installing a child restraint system on the front-passenger seat, observe the

notes on child restraint systems on the front-passenger seat (> page 44).

- Notes on seat belts (> page 35).

Activating/deactivating the special seatbelt retractor of the seat belt

 **WARNING**

If the seat belt is released while driving, the child restraint system will no longer be secured properly. The special seat belt retractor is disabled and the inertia reel draws in a portion of the seat belt. The seat belt cannot be immediately refastened. There is an increased risk of injury, possibly even fatal.

Stop the vehicle immediately, paying attention to road and traffic conditions. Reactivate the special seat belt retractor and secure the child restraint system properly.

When activated, the special seat belt retractor ensures that the seat belt on the front-passenger seat does not slacken once the child restraint system is secured.

Always comply with the child restraint system manufacturer's installation instructions when installing and removing the child restraint system.

Activating the special seat belt retractor:

- ▶ Pull the seat belt out fully and let the seat belt retractor retract it again. When the special seat belt retractor is activated, you should hear a ratcheting sound.
- ▶ Push the child seat restraint system down until the seat belt is tight.

Deactivating the special seat belt retractor:

- ▶ Press the release button on the seat belt buckle.
- ▶ Hold the belt tongue firmly and guide it back towards the belt loop.

Securing Top Tether

Top Tether can reduce the risk of injury, since it provides an additional connection

between the child restraint system and the vehicle.

The child restraint system must be equipped with a Top Tether belt.

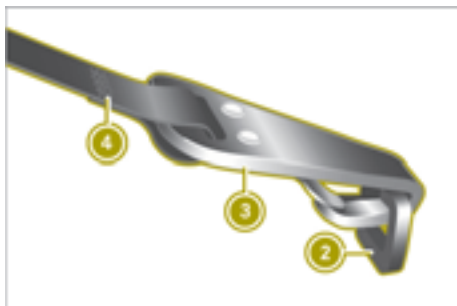
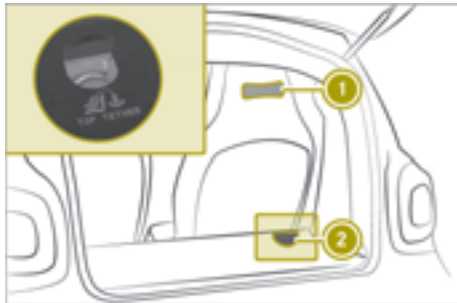

Top Tether anchorage ② is mounted to the cargo compartment floor.

- ▶ Route Top Tether belt ④ back over the head restraint, keeping it as central as possible, into the cargo compartment through loop ①.
- ▶ Hook Top Tether hook ③ of Top Tether belt ④ into Top Tether anchorage ②. Lift up the carpet a little if necessary. Make sure that:
 - Top Tether hook ③ is hooked into Top Tether anchorage ② as shown.
 - Top Tether belt ④ is not twisted.
- ▶ Tension Top Tether belt ④. Always comply with the child restraint system manufacturer's installation instructions when doing so.

Child restraint systems on the front-passenger seat

Notes on child restraint systems

If you secure a child in a child restraint system on the front-passenger seat, always observe the information and safety notes on the automatic front-passenger front air bag deactivation system (▷ page 39).

You avoid risks resulting from:

- a child restraint system that is not detected by the automatic front-passenger front air bag deactivation system
- the unintentional deactivation of the front-passenger front air bag
- positioning the child restraint system incorrectly

Notes on rearward and forward facing child restraint systems

If you secure a child in a rearward-facing child restraint system on the front-passenger seat, always make sure that the front-passenger front air bag is deactivated. This is only the case if the PASSENGER AIR BAG OFF indicator lamp is permanently lit (▷ page 39).

When using child restraint systems on the front-passenger seat, always observe the following:

- Move the front-passenger seat as far back as possible.
- The base of the child restraint system must lie fully against the seat cushion of the front-passenger seat.
- The back of a forward-facing child restraint system must lie as flat as possible against the front-passenger backrest. The child restraint system must not touch the roof or be put under strain by the head restraint.
- Adjust the angle of the seat backrest accordingly.
- Always make sure that the shoulder belt strap is correctly routed from the vehicle belt outlet to the shoulder belt guide on the child restraint system. The shoulder belt

strap must be routed forward and rearward from the vehicle belt outlet.

- Never place objects, such as a cushion, under or behind the child restraint system.

Always comply with the manufacturer's installation and operating instructions for the child restraint system used.

Pets in the vehicle

WARNING

If you leave animals unattended or unsecured in the vehicle, they could press buttons or switches, for example.

As a result, they could:

- activate vehicle equipment and become trapped, for example
- activate or deactivate systems, thereby endangering other road users

Unsecured animals could also be flung around the vehicle in the event of an accident or sudden steering or braking, thereby injuring vehicle occupants. There is a risk of an accident and injury.

Never leave animals unattended in the vehicle. Always secure animals properly during the journey, e.g. use a suitable animal transport box.

Driving safely

Driving safety system limitations

I Make sure you have suitable tires, so that assistance systems and driving safety systems can work as effectively as possible.



If you fail to adapt your driving style or become distracted, the driving safety systems can neither reduce the risk of accident nor override the laws of physics. Driving safety systems are merely aids designed to assist driving. You are responsible for the distance to the vehicle in front, for vehicle speed and for braking in good time. Always adapt your driving style to suit the prevailing road, weather and traffic conditions and

maintain a safe distance from the vehicle in front. Drive carefully.

For safety reasons, smart recommends that you only use snow chains that have been specially approved for your vehicle by smart. Further information can be obtained at a smart center or a qualified specialist workshop.

Braking with ABS (Anti-lock Braking System)

ABS regulates brake pressure in such a way that the wheels do not lock when you brake. This allows you to continue steering the vehicle when braking.

The  (Canada only) or  (USA only) abs warning lamp in the instrument cluster lights up when the ignition is switched on. It goes out when the engine is running.

ABS works from a speed of about 4 mph (6 km/h), regardless of road-surface conditions. ABS intervenes in the case of slippery road surfaces, even when you only brake gently.

- ▶ **To brake while ABS intervenes:** continue to depress the brake pedal with force until the braking situation is over.
- ▶ **To make a full brake application:** depress the brake pedal with full force.

WARNING

If ABS is faulty, the wheels could lock when braking. The steerability and braking characteristics may be severely impaired. Additionally, further driving safety systems are deactivated. There is an increased danger of skidding and accidents.

Drive on carefully. Have ABS checked immediately at a qualified specialist workshop.

Using the forward collision warning

Useful information

If a risk of collision with the vehicle in front is detected, the forward collision warning alerts the driver both visually and acoustically.

With the help of the radar sensor system, the forward collision warning can detect obstacles that are in the path of your vehicle for an extended period of time.

Up to a speed of approximately 45 mph (70 km/h), the forward collision warning can react to stationary obstacles, such as stationary or parked vehicles.

Please note

- Observe the section on "Limitations of the driving safety systems" (▷ page 45).

WARNING

The distance warning function does not react:

- to people or animals
- to oncoming vehicles
- to crossing traffic
- when cornering

The distance warning function may not give warnings in all critical situations. There is a risk of an accident.

Always pay careful attention to the traffic situation and be ready to brake.

Always adapt your speed to suit the prevailing road and traffic conditions.

WARNING

The distance warning function cannot always clearly identify objects and complex traffic situations.

In such cases, the distance warning function may:

- give an unnecessary warning
- not give a warning

There is a risk of an accident.

Always pay careful attention to the traffic situation and do not rely solely on the distance warning function.

The  warning lamp in the instrument cluster lights up if:

- the vehicle is rapidly approaching a vehicle traveling in front or a stationary object.

In this case, an intermittent warning tone also sounds

Detection can be restricted under the following conditions:



- the vehicle is new or service work has been carried out on the system. In this case, observe the information on breaking-in the vehicle
- the sensors are dirty or covered
- in heavy rain or snow
- there is interference from other radar sources, e.g. in parking garages
- the vehicle traveling in front is narrow, e.g. a motorcycle
- the vehicle traveling in front is traveling on a different line

Following any damage to the front end of the vehicle, have the configuration and operation of the radar sensor checked at a qualified specialist workshop. This also applies to collisions at slow speeds where there is no visible damage to the front of the vehicle.

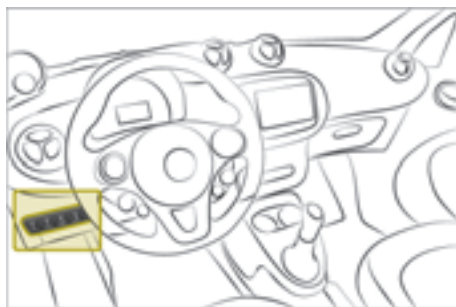
Activating/deactivating the forward collision warning



When the ignition is restarted, the forward collision warning is automatically activated.

- Press the  switch. If the forward collision warning is deactivated, the LED on the  switch lights up. **On-board computer with color display:** the display shows a message.

Driving with ESP®

If ESP® detects that the vehicle is deviating from the direction desired by the driver, one

or more wheels are braked to stabilize the vehicle.



ESP® supports the driver when pulling away on wet or slippery roads. ESP® can also stabilize the vehicle during braking. ESP® comprises ETS (Electronic Traction System) and Crosswind Assist.

ETS brakes the drive wheels individually if they spin. This enables you to pull away and accelerate on slippery surfaces, for example, if the road surface is slippery on one side.

Strong crosswind gusts can impair the road-holding of your vehicle when driving straight ahead.

Crosswind Assist reduces these impairments. Crosswind Assist is active at vehicle speeds above 45 mph (70 km/h) when driving straight ahead or cornering gently.

If ESP® intervenes, pull away carefully and adapt your driving style to the prevailing road and weather conditions.

If the  warning lamp goes out before beginning the journey, ESP® is active. If ESP® intervenes, the  warning lamp flashes in the instrument cluster.

WARNING

If ESP® is malfunctioning, ESP® is unable to stabilize the vehicle. Additionally, further driving safety systems are deactivated. This increases the risk of skidding and an accident.

Drive on carefully. Have ESP® checked at a qualified specialist workshop.

Information on EBD (electronic brake force distribution)

EBD monitors and controls the brake pressure on the rear wheels to improve driving stability while braking.

WARNING

If EBD is malfunctioning, the rear wheels can lock, e.g. under full braking. This increases the risk of skidding and an accident.

You should therefore adapt your driving style to the different handling character-

istics. Have the brake system checked at a qualified specialist workshop.

Understanding functions of the Smart-Key

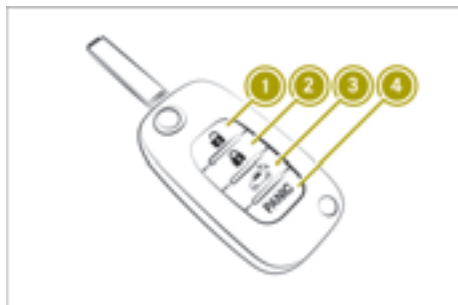

- ① Unlocks the vehicle
- ② Locks the vehicle
- ③ **smart fortwo coupé:** Opens the upper tailgate (press and hold)
- ③ **smart fortwo cabrio:** Opens the soft top (press and hold)
- ④ **PANIC** Switches the panic alarm on and off (press and hold)

► **To unlock centrally:** press the button. The turn signals flash once.

ⓘ After unlocking, open the vehicle within approximately 2 minutes to prevent it from locking itself again and arming the anti-theft alarm system.

► **To unlock and open the upper tailgate (smart fortwo coupé):** press and hold the button.

► **To open the soft top to the B-pillar (smart fortwo cabrio):** press and hold the button.

► **To lock centrally:** press the button. The turn signals flash twice.

► **To switch the panic alarm on and off:** press the button for approximately two seconds. An alarm sounds and the exterior lighting flashes.

Opening the door

► Press the button on the SmartKey.

► Open the door.

ⓘ After unlocking, open the vehicle within approximately 2 minutes to prevent it from

locking itself again and arming the anti-theft alarm system.

Correct driver's seat position

⚠ WARNING

You could lose control of your vehicle if you do the following while driving:

- adjust the driver's seat, steering wheel or mirrors
- fasten the seat belt

There is a risk of an accident.

Adjust the driver's seat, steering wheel or mirrors and fasten your seat belt before starting the engine.



Observe the following rules on the correct driver's seat position:

- the driver must be as far away from the driver's air bag as possible (▷ page 37).
- the driver must be wearing seat belt ③ properly.
- the driver must be able to depress the pedals properly.
- the driver must be able to move their legs freely.
- the driver must be able to reach steering wheel ① with their arms slightly bent.
- the driver must be able to see all the displays in the instrument cluster clearly.
- move seat backrest ② to an almost vertical position.
- you are sitting in a normal upright position.
- the seat belt must fit snugly across your body.

- the seat belt must be routed across the middle of your shoulder.
- the seat belt must be routed in your pelvic area across the hip joints.
- adjust the rear-view and exterior mirror so that the driver has a good view of the road and traffic conditions.

Adjusting the seats

Please note

WARNING

Children could become trapped if they adjust the seats, particularly when unattended. There is a risk of injury.

When leaving the vehicle, always take the SmartKey with you and lock the vehicle. Never leave children unsupervised in the vehicle.

WARNING

If the driver's seat is not engaged, it could move unexpectedly while the vehicle is in motion. This could cause you to lose control of the vehicle. There is a risk of an accident.

Always make sure that the driver's seat is engaged before starting the vehicle.

WARNING

When you adjust a seat, you or other vehicle occupants could become trapped, e.g. on the seat guide rail. There is a risk of injury.

Make sure when adjusting a seat that no one has any body parts in the sweep of the seat.

WARNING

The seat belt does not offer the intended level of protection if you have not moved the backrest to an almost vertical position. When braking or in the event of an accident, you could slide underneath the seat belt and sustain abdomen or neck injuries,

for example. This poses an increased risk of injury or even fatal injury.

Adjust the seat properly before beginning your journey. Always ensure that the backrest is in an almost vertical position and that the shoulder section of your seat belt is routed across the center of your shoulder.

WARNING

If the steering wheel is unlocked while the vehicle is in motion, it could change position unexpectedly. This could cause you to lose control of the vehicle. There is a risk of an accident.

Before starting off, make sure the steering wheel is locked. Never unlock the steering wheel while the vehicle is in motion.

WARNING

You could lose control of your vehicle if you do the following while driving:

- adjust the driver's seat, steering wheel or mirrors
- fasten the seat belt

There is a risk of an accident.

Adjust the driver's seat, steering wheel or mirrors and fasten your seat belt before starting the engine.

- ! Make sure that there are no objects in the footwell under or behind the seats when moving the seats back. There is a risk that the seats and/or the objects could be damaged.

Observe the safety notes on "Air bags" (> page 38) and "Children in the vehicle" (> page 42).

Adjusting the seat fore-and-aft position

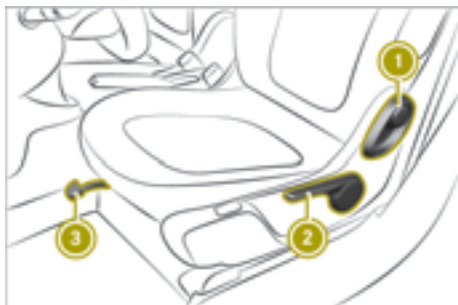

Seat with a lever

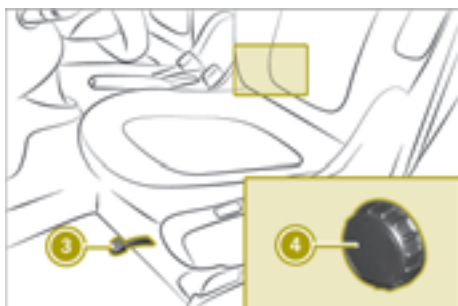

Seat with a handwheel

To adjust the seat fore-and-aft position, the seat belt must not be fastened.

- ▶ Lift lever ③.
- ▶ Slide the seat forward or back.
The seat engages audibly.

Adjusting the seat height (seat with a lever only)

- ▶ Pull handle ② up or push it down several times.

Adjusting the seat backrest (seat with a lever)

- ▶ Pull lever ① forward.
- ▶ At the same time, move the backrest forward or back.

Adjusting the seat backrest (seat with a handwheel)

- ▶ Turn handwheel ④ forward or back.

Adjusting the mirrors

Adjusting the rear-view mirror



- ▶ Move the rear-view mirror up, down, left or right.

Setting the rear-view mirror to anti-glare

- ▶ Fold lever ① forward.

Adjusting the exterior mirrors manually

WARNING

You could lose control of your vehicle if you do the following while driving:

- adjust the driver's seat, steering wheel or mirrors
- fasten the seat belt

There is a risk of an accident.

Adjust the driver's seat, steering wheel or mirrors and fasten your seat belt before starting the engine.

WARNING

The exterior mirror on the front-passenger side reduces the size of the image. Visible

objects are actually closer than they appear. This means that you could misjudge the distance from road users traveling behind, e.g. when changing lane. There is a risk of an accident.

For this reason, always make sure of the actual distance from the road users traveling behind by glancing over your shoulder.



- Move lever ① up, down, left or right.

Adjusting the exterior mirrors electrically

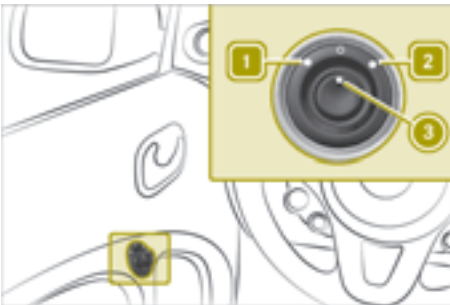

In order to adjust the exterior mirrors electrically, the ignition must be switched on.

- To select the left or right exterior mirror: turn control ③ left ① or right ②.
- To adjust the exterior mirrors: move control ③ up, down, left or right.

Starting the engine

Please note

WARNING

If children are left unsupervised in the vehicle, they could:

- open the doors, thus endangering other people or road users.
- get out and disrupt traffic.
- operate the vehicle's equipment.

Additionally, children could set the vehicle in motion if, for example, they:

- release the parking brake.
- shifting the automatic transmission out of park position **P**
- Start the engine.

There is a risk of an accident and injury.

When leaving the vehicle, always take the SmartKey with you and lock the vehicle.

Never leave children or animals unattended in the vehicle. Always keep the SmartKey out of reach of children.

WARNING

If you attach heavy or large objects to the SmartKey, the SmartKey could be unintentionally turned in the ignition lock. This could cause the engine to be switched off. There is a risk of an accident.

Do not attach any heavy or large objects to the SmartKey. Remove any bulky key rings before inserting the SmartKey into the ignition lock.



- 0** To insert the SmartKey into the ignition lock
- 1** To switch on the power supply
- 2** To switch on the ignition
- 3** To start the engine

Automatic transmission

- ▶ Turn the SmartKey to position **3**. The **READY** indicator appears in the instrument cluster. A tone sounds.
- ▶ Shift out of transmission position **P** or **N**.

Pulling away

Please note

WARNING

Objects in the driver's footwell may restrict the clearance around the pedals or block a depressed pedal. This jeopardizes the operating and road safety of the vehicle. There is a risk of an accident.

Stow all objects securely in the vehicle so that they do not get into the driver's footwell. When using floor mats or carpets, make sure that they are properly secured so that they do not slip or obstruct the pedals. Do not place several floor mats or carpets on top of one another.

 **WARNING**

Unsuitable footwear can hinder correct usage of the pedals, e.g.:

- shoes with thick soles
- shoes with high heels
- slippers

There is a risk of an accident.

Wear suitable footwear to ensure correct usage of the pedals.

 **WARNING**

If you switch off the ignition while driving, safety-relevant functions are only available with limitations, or not at all. This could affect, for example, the power steering and the brake boosting effect. You will require considerably more effort to steer and brake. There is a risk of an accident.

Do not switch off the ignition while driving.

 **WARNING**

If you operate mobile communication equipment when driving, you may be distracted from the traffic situation. You could also lose control of the vehicle. There is a risk of an accident.

Only operate this equipment when the vehicle is stationary.

Observe the legal requirements for the country in which you are driving. Some jurisdictions prohibit the driver from using a mobile phone while driving a vehicle.

If you make a call while driving, always use hands-free mode. Only use the telephone when the traffic situation permits. If you are unsure, pull over to a safe location and stop before using the telephone.

Bear in mind that at a speed of only 30 mph (approximately 50 km/h), the vehicle covers a distance of 44 ft (approximately 14 m) per second.

Note the following when pulling away:

- Do not drive with the parking brake applied.
- Use caution when pulling away on slippery surfaces.
- Do not allow tires to spin.
- Depress the brake pedal and keep it depressed.
- Press the release button on the selector lever.
- Shift the gear selector lever to position **D** or **R**.

Drinking and driving **WARNING**

Drinking and driving and/or taking drugs and driving are very dangerous combinations. Even a small amount of alcohol or drugs can affect your reflexes, perceptions and judgment.

The possibility of a serious or even fatal accident is greatly increased when you drink or take drugs and drive.

Do not drink or take drugs and drive or allow anyone to drive who has been drinking or taking drugs.

Using the parking brake**Please note** **WARNING**

If the parking brake has not been fully released when driving, the parking brake can:

- overheat and cause a fire
- lose its hold function.

There is a risk of fire and an accident. Release the parking brake fully before driving off.

 **WARNING**

If you must brake the vehicle with the parking brake, the braking distance is

considerably longer and the wheels could lock. There is an increased danger of skidding and accidents.

Only use the parking brake to brake the vehicle when the service brake is faulty. Do not apply the parking brake too firmly. If the wheels lock, release the parking brake until the wheels begin turning again.

WARNING

If you leave children unsupervised in the vehicle, they could set it in motion by, for example:

- release the parking brake.
- shift the automatic transmission out of the parking position **P**.
- start the engine.

In addition, they may operate vehicle equipment and become trapped. There is a risk of an accident and injury.

When leaving the vehicle, always take the SmartKey with you and lock the vehicle. Never leave children unsupervised in the vehicle.

Applying the parking brake

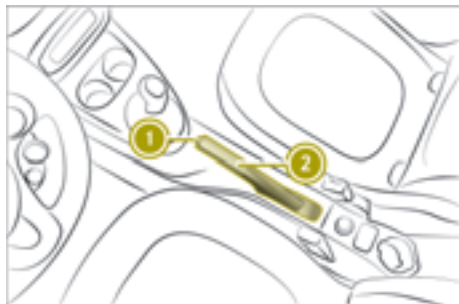

- ▶ Pull parking brake ② up.

The brake lights do not light up when you brake the vehicle with the parking brake.

Release Parking Brake

- ▶ Depress the brake pedal and keep it depressed.
- ▶ Press release button ① on parking brake ② and move the parking brake down to the stop.

Hill start assist

WARNING

After a short time, hill start assist will no longer brake your vehicle and it could roll away. There is a risk of an accident and injury.

Therefore, quickly move your foot from the brake pedal to the accelerator pedal. Never leave the vehicle when it is held by hill start assist.

Hill start assist keeps the vehicle in place when driving uphill as soon as the brake pedal is released.

Hill start assist is only active in the following situations:

- when pulling away on an uphill slope
 - when the parking brake is released
 - the transmission is not in position **N**
 - ESP[®] is functioning correctly
- ▶ Release the brake pedal.
The vehicle is then held for about one second.
 - ▶ Pull away.

Automatic transmission

Please note

WARNING

The automatic transmission switches to neutral position **N** when you switch off the engine. The vehicle may roll away. There is a risk of an accident.

Before switching off the engine, always switch to parking position **P**. Prevent the parked vehicle from rolling away by applying the parking brake.

Transmission position display

- ❗ Only shift into neutral **[N]** when the vehicle is stationary. Otherwise, you could damage the transmission.
- ❗ Only shift into reverse gear **[R]** when the vehicle is stationary. Otherwise, you could damage the transmission.
- ❗ Only engage park position **[P]** when the vehicle is stationary. Otherwise, you could damage the transmission.

The following transmission positions are available:

- **[P]** Park position
Position P should not be used to brake the vehicle when parking. To secure the vehicle, apply the parking brake in addition to shifting to transmission position P.
- **[R]** Reverse gear
- **[N]** Neutral
No power is transmitted from the engine to the drive wheels.
- **[D]** Drive

Changing the transmission position

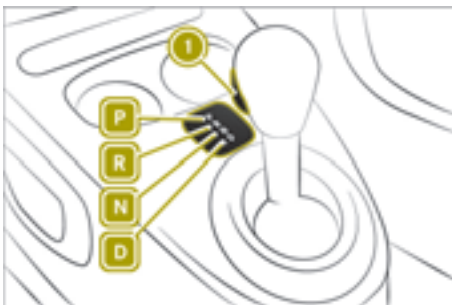

- [P]** Park position with parking lock
- [R]** Reverse gear
- [N]** Neutral
- [D]** Drive

The ignition must be switched on in order to shift the transmission to positions **[P]**, **[N]** or **[R]**. To shift the transmission from position P, you must also depress the brake pedal.

- ▶ Press release knob ①.
- ▶ Shift the selector lever to the desired transmission position.

Maximum acceleration (kickdown)

To reach maximum acceleration, use kick-down:

- ▶ Depress the accelerator pedal beyond the pressure point.
- ▶ Ease off the accelerator pedal once the desired speed is reached.

Using the turn signals



The ignition must be switched on in order to use the turn signals.

- ▶ To indicate: press the combination switch in the direction of arrow **1** (right) or **2** (left) past the point of resistance.
- ▶ To indicate briefly: press the combination switch briefly to the point of resistance. The turn signal flashes three times.

Acoustic presence indicator

Useful information

Vehicles with an electric motor generate much less driving noise than vehicles with internal combustion engines. As a result, your vehicle may not be heard by other road users in certain situations.

In order to allow your vehicle to be heard when it is moving at slow speeds, a sound generator installed in the vehicle produces a specific noise at speeds between 0 and 18 mph (30 km/h). This function is called the acoustic presence indicator. It makes it possible for other road users, especially pedestrians and cyclists, to hear the vehicle bet-

ter. The acoustic presence indicator can also be heard in the vehicle interior.

The volume of the acoustic presence indicator depends on the engine speed. The greater the acceleration, the louder the noise. At speeds of over 18 mph (30 km/h), the noise is switched off. Above this speed, the driving noise naturally created by the vehicle is typically sufficient for the vehicle to be heard in good time by other road users.

Driving economically

Notes on economical driving

In order to save energy, smart electric drive recuperates part of the kinetic energy and uses it to charge the high-voltage battery. When the driver releases the accelerator, the vehicle is braked.

In the following cases, the vehicle will slow down only partially or not at all when the accelerator pedal is released:

- the gear lever is in position **D** and the vehicle is rolling backwards
- the gear lever is in position **R** and the vehicle is rolling forwards

On steep slopes, the vehicle may not be held at all or may only be held to a limited extent.

In the following cases recuperation is restricted:

- the high-voltage battery is fully charged or too cold
- the power electronics or the engine has overheated

Recommendations for driving economically:

- accelerate moderately
- pay attention to the power display (> page 57)
- drive with care
- use the air conditioning and electrical consumers in moderation
- have maintenance work carried out at the specified service intervals

ECO mode can be used to save additional energy.

ECO mode has the following characteristics:

- Reduced torque and significantly reduced power. This supports a particularly effi-

cient, steady driving style. The speed is reduced to approx. 70 mph (110 km/h).

- Output of air conditioning and heating is reduced.
- Recuperation is maximized.
- Less acceleration.

In order to increase acceleration in ECO mode, press the accelerator pedal beyond the pressure point.

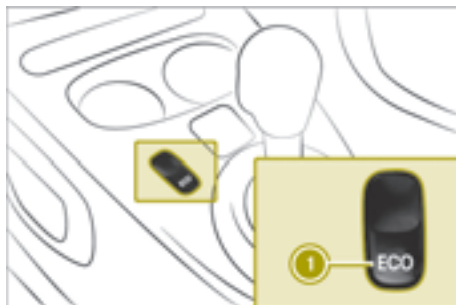

Switching ECO mode on and off

- ▶ Press button ①.

If the energy-saving function is activated, the **ECO** display is shown in the on-board computer.

The energy-saving function is switched off when the ignition is restarted.

Power and charge level display

Useful information



- ① Power display
- ② Charge level display

Power display ① together with charge level display ② can be positioned to the left or to

the right. When the vehicle is unlocked, the charge level display lights up.

Power display

! Do not hang any objects on the power display.

This could cause the dashboard clock to be torn out of its anchorage point and be severely damaged.

Power display ① contains two areas:

- Area to the right of 0
The current power that the high-voltage battery provides is shown here. 100% corresponds to the peak performance of the high-voltage battery.
- Area to the left of 0
The vehicle's level of recuperation in over-run mode and when braking is shown here.

The LED ring in power display ① shows the power output available.

When the needle of power display ① is in the "OFF" position, the vehicle cannot be driven for the following reasons:

- The ignition is switched off.
- The gear lever has not been moved to position **N** or **P** to start the drive system.
- The charging cable is still connected to the vehicle socket.
- There is insufficient power available from the high-voltage battery.
- There is a malfunction in the vehicle's high-voltage electrical system.

When the drive system is started, power display needle ① is at position "0". The **READY** indicator appears in the instrument cluster. A tone sounds. The vehicle is ready for driving.

Charge level display

! Do not hang any objects on the charge level display.

Otherwise, the display could be torn out of its anchorage and be damaged.

Charge level display ② displays the charge level of the high-voltage battery as a percentage.

The high-voltage battery has reached the reserve level in the following cases:

- The **Battery Reserve Level** message appears in the display.
- When the red area of condition of charge display ② has been reached.

i Charge the high-voltage battery when the condition of charge falls below 20%.

Understanding the eco score display in the on-board computer

Useful information

The eco score display provides information on how to drive economically.

A higher percentage indicates a more economical driving style.

The percentage of the eco score display is only calculated after a short distance. If the ignition remains switched off for longer than 4 hours, the eco score display will be reset.

Color display



The percentage in the eco score display is calculated using the following categories:

- **Speed:** the value increases when driving at low speeds.
- **Anticipation:** the value increases when unnecessary acceleration and deceleration is avoided.

Using the eco score display in the smart Media-System

Calling up the eco score menu

- ▶ Select **Vehicle > eco score**.

Evaluating the current trip

- ▶ Select **Current trip**.
The following rating information and values appear:
 - Bar graphs for **Speed** and **Anticipation**
 - Distance covered
 - Total eco score as a percentage

Saving the current trip

- ▶ Select **Current trip > Save**.
- ▶ Select the category under which you want to save the trip.
The values for the current trip will be added to the category selected and the current trip will be reset. In the instrument cluster, the values for the "From start" trip computer and eco score display will be reset.

Comparing the current trip with the saved trips from a category



- ① Last trip saved in this category
 - ② Average value for the category
 - ③ Best trip in the category
- ▶ Select **Current trip > + > Compare**.
 - ▶ Select category.
A comparison of the values for the current trip with the values of the selected category appears.
 - ▶ Select the comparison value ①, ② or ③.
The current trip is compared to the respective comparison value from the category.

Resetting the current trip data

- ▶ Select **Current trip > Reset**.
- ▶ Select **Yes**.
In the instrument cluster, the values for the "From start" trip computer and eco score display will be reset.

Activating/deactivating eco score after a trip

- ▶ To activate: select **Current trip > + > Show eco score after trip**.
- ▶ To deactivate: select **Current trip > + > Hide eco score after trip**.

Displaying eco score for saved trips in a category

- ▶ Select **Vehicle > eco score > My preferred trips**.
- ▶ Select category.
eco score contains the following comparison values for each category:

- Summary
- Last value
- Average value
- Best value

The following types of evaluations are available for the **Last trip saved** category:

- Summary
- Detailed report

Renaming a category

At least one trip must be stored in the respective category.

- ▶ Select **Vehicle > eco score > My preferred trips > + > Rename this category**.

Resetting the eco score of one category

At least one trip must be stored in the respective category.

- ▶ Select **Vehicle > eco score > My preferred trips > + > Reset this category**.

Braking correctly

Please note

WARNING

If you rest your foot on the brake pedal while driving, the braking system can overheat. This increases the stopping distance and can even cause the braking system to fail. There is a risk of an accident.

Never use the brake pedal as a footrest. Never depress the brake pedal and the accelerator pedal at the same time.

The vehicle slows down as soon as the accelerator pedal is released. This behavior allows energy to be recuperated as the engine is used as a generator and the high-voltage battery is charged.

Braking on steep downhill gradients

When driving on downhill gradients, observe the following rules:

- Do not move the gear lever to position N.
- If energy recuperation is limited, brake additionally at intervals.

Braking on wet road surfaces

There may be a delayed brake response when driving on wet roads, after driving through a car wash or after driving through deep water.

- ▶ Maintain a greater distance from the vehicle in front.
- ▶ Brake more firmly.

Braking on salt-treated roads

If you drive on salt-treated roads, a layer of salt may form on the brake discs and pads. This increases the vehicle's braking distance.

- ▶ In order to prevent any salt build-up, apply the brakes occasionally while paying attention to the traffic conditions.
- ▶ Brake carefully at the end of the journey and when starting the next journey.
- ▶ Maintain a greater distance to the vehicle in front.

Maintaining the brakes

- ! The brake fluid level may be too low, if:
 - if the red brake warning lamp lights up in the instrument cluster and
 - you hear a warning tone while the engine is running

Observe additional warning messages in the multifunction display.

The brake fluid level may be too low due to brake pad wear or leaking brake lines.

Have the brake system checked immediately. Consult a qualified specialist workshop to arrange this.

- ! A function or performance test should only be carried out on a 2-axle dynamometer. If you wish to operate the vehicle on such a dynamometer, please consult a qualified specialist workshop in advance. You could otherwise damage the drive train or the brake system.

- ! As the ESP® system operates automatically, the engine and the ignition must be switched off (the SmartKey must be in position 0 or 1 in the ignition lock) if:

- the parking brake is tested using a brake dynamometer (maximum 10 seconds).
- the vehicle is towed with the front axle raised.

Braking triggered automatically by ESP® may seriously damage the brake system.

All checks and maintenance work on the brake system must be carried out at a qualified specialist workshop.

Have brake pads/linings installed and brake fluid replaced at a qualified specialist workshop.

If the brake system has only been subject to moderate loads, you should test the functionality of your brakes at regular intervals.

When having brake pads/linings installed, smart recommends that you only use those which are approved for smart vehicles or are of an equivalent quality standard. Brake pads/linings which have not been approved for smart vehicles or which are not of an equivalent quality could affect your vehicle's operating safety.

Driving on wet roads

Hydroplaning

Depending on driving style and tire tread depth, hydroplaning can occur on the road. Adapt your driving style as follows:

- ▶ Reduce the speed.
- ▶ Brake carefully.
- ▶ Avoid sudden steering movements
- ▶ Avoid tire ruts.

Fording

! Bear in mind that vehicles traveling in front or in the opposite direction create waves. This may cause the maximum permissible water depth to be exceeded.

Failure to observe these notes may result in damage to the engine, electrical systems and transmission.

Prevent water from entering the vehicle interior or the engine compartment. Observe the following when driving through standing water:

- ▶ The water level should not exceed the lower edge of the vehicle body in still water
- ▶ Drive no faster than walking pace.

Winter driving

- ▶ Before the start of winter, have the vehicle checked at a qualified specialist workshop.
- ▶ Use winter tires and, if applicable, snow chains.

- ▶ Drive carefully and avoid sudden acceleration, turning and braking on slippery road surfaces.
- ▶ Do not use cruise control.
- ▶ If the vehicle skids, take corrective steering actions to counteract the movement.
- ▶ If the vehicle skids, shift the transmission to position **N**.
- ▶ Do not use the outside temperature display as a way to determine if conditions are icy.
- ▶ Observe the road surface.

Using cruise control

Please note

WARNING

If you call up the stored speed and it is different to the current speed, the vehicle will accelerate. If you are not aware of the stored speed, the vehicle may accelerate unexpectedly. There is a risk of an accident.

Pay attention to the road and traffic conditions before calling up the stored speed. If you do not know the stored speed, store the desired speed again.

Cruise control is used in order to drive at a constant speed for a prolonged period.

The driver is responsible for driving the vehicle in a safe manner, controlling the vehicle speed and braking in good time.

If there is a change of drivers, inform the new driver of the speed stored.

Cruise control requires:

- favorable weather and good visibility
- good road and traffic conditions

Cruise control does not brake the vehicle automatically.

- reduce the vehicle speed by applying the brakes.

Speed regulation is canceled when the following occur:

- braking (including the parking brake)
- ESP® intervention

On downhill gradients or when accelerating briefly, cruise control may interrupt speed

regulation. Afterwards, the set speed is applied again.

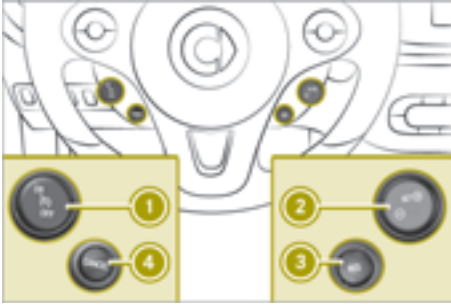

Cruise control is ready for use at speeds above 25 mph (40 km/h).

Activating cruise control



- ▶ Press the upper section of button ①. The  symbol appears in the instrument cluster display.

Storing the current speed

- ▶ Press  button ②.
- ▶ Remove your foot from the accelerator pedal.  SET appears in the instrument cluster display.

Adjusting the stored speed

- ▶ Press (+) or (-) button ② until the desired speed is reached.

Interrupting cruise control

- ▶ Press  button ④. The stored speed can be accessed again later.

The stored speed is deleted when the engine is switched off.

Calling up the stored speed

- ▶ Press  button ③.
- ▶ Remove your foot from the accelerator pedal.

Deactivating cruise control

- ▶ Press button ① to the OFF center position. The  symbol in the instrument cluster display goes out. The stored speed is deleted.

The stored speed is deleted when the engine is switched off.

Charging the high-voltage battery

Please note

DANGER

The vehicle's high-voltage electrical system is under high voltage. If you modify components in the vehicle's high-voltage electrical system or touch damaged components, you may be electrocuted. The components in the vehicle's high-voltage electrical system may be damaged in an accident, although the damage is not visible. There is a risk of fatal injury.

Following an accident, do not touch any high-voltage components and never modify the vehicle's high-voltage electrical system. Have the vehicle towed away after an accident and the vehicle's high-voltage electrical system checked by a qualified specialist workshop.

WARNING

In the event of a vehicle fire, the internal pressure of the high-voltage battery can exceed a critical value. In this case flammable gas escapes through a ventilation valve on the underbody. The gas can ignite. There is a risk of injury.

Leave the danger zone immediately. Secure the danger area at a suitable distance, whilst observing legal requirements.

 **DANGER**

Connecting the charging cable to the mains supply via incorrectly installed mains sockets or by means of adapters, extension cables or similar could cause a fire or an electric shock. There is a risk of fatal injury.

To avoid hazardous situations, observe the following:

- Only connect the charging cable to mains sockets:
 - which have been properly installed and
 - which have been inspected by a qualified electrician
- For safety reasons, only use the charging cables supplied with the vehicle, or charging cables which have been approved for use with this vehicle.
- Never use a damaged charging cable.
- Do **not** use:
 - extension cables
 - extension reels
 - multiple sockets
- Never use socket adapters to connect the charging cable to the mains socket. The only exception being if the adapter has been tested and approved by the manufacturer for charging the high-voltage battery of an electric vehicle.
- Observe the safety notes in the operating instructions for the socket adapter.

 **DANGER**

Connecting the charging cable to the wallbox via an incorrectly installed wallbox or adapter, extension cable or similar could cause a fire or an electric shock. There is a risk of fatal injury.

To avoid hazardous situations, observe the following:

- Only connect the charging cable to a wallbox that:
 - is installed correctly and
 - has been inspected by a qualified electrician
- For safety reasons, only use charging cables that have been tested and approved by the manufacturer for charging the high-voltage battery in an electric vehicle.
- Never use damaged charging cables.
- Do not extend the charging cable.
- Do not use an adapter.
- Always observe the safety notes in the wallbox's operating instructions.

The vehicle's high voltage electrical system is under high voltage.

- Do not tamper with the high-voltage components or the orange cables of the high-voltage electrical system.
- Do not touch the high-voltage components or the orange cables of the high-voltage electrical system in a vehicle which has been involved in an accident.
- Do not touch damaged components or the damaged orange cables of the high-voltage electrical system.
- Do not remove the covers of the high-voltage electrical system components which are marked with a yellow warning sticker.

For safety reasons, only use the charging cable which is supplied with the vehicle or which has been approved by smart for this vehicle.

Do not clean the vehicle whilst charging.

Useful information**Method of operation**

The vehicle is equipped with a high-voltage battery for driving. The high-voltage battery stores the energy needed to operate the electric motor and releases it again.

The electric motor uses energy stored in the high-voltage battery for pulling away and accelerating.

In overrun mode, kinetic energy is converted into electrical energy by recuperation and stored in the high-voltage battery.

The high-voltage battery can be charged as follows:

- by recuperation while the vehicle is in motion
- with the suitable charging cable at a mains socket while the vehicle is stationary
- with the suitable charging cable at a wall-box while the vehicle is stationary
- with the suitable charging cable at a charging station while the vehicle is stationary

Not all charging variants are available in all countries.

The high-voltage battery can be charged in a voltage range from 100 V to 240 V.

- i** If possible only charge the high-voltage battery when the charge is below 80%. Charge the high-voltage battery at the latest when the charge falls below 20%.

Discharged high-voltage battery

The high-voltage electrical system switches off if the high-voltage battery is completely discharged. This protects the high-voltage battery from exhaustive discharge.

- i** Switching the ignition on and then off can reactivate the high-voltage electrical system temporarily. This allows the vehicle to be parked safely.

Do not allow the vehicle's high-voltage battery to remain in a discharged or almost fully discharged state for more than 14 days. You can check the condition of charge in the charge level display (> page 57).

Extreme outside temperatures

The efficiency of the high-voltage battery is temperature-dependent and is significantly reduced at low or very high temperatures. In addition, the electrolytes used may freeze at very low temperatures.

The LED ring in power display shows the power output available (> page 57).

Energy consumption and range

The available energy in the high-voltage battery is fundamentally reduced by the following factors:

- low outside temperatures
- operating the air-conditioning system or heating
- switching on electrical consumers

Low outside temperature and prolonged periods of inactivity without charging can have the following effects:

- the high-voltage battery output is significantly reduced
- charging periods may be longer

In extreme cases, it may not be possible to start the vehicle as a result. You should therefore always ensure that the high-voltage battery is fully charged or that the charging cable is connected when parking the vehicle for an extended period of time at low outside temperatures.

As the gets older, the capacity of the high-voltage battery will diminish in the course of its lifetime. This reduces the maximum range and the maximum acceleration.

Battery care

Observe the following notes on battery care:

- avoid storing and transporting the vehicle at high temperatures and over an extended period of time (e.g. transporting it in a container)
- connect the vehicle to a power supply when parking it for an extended period of time
- temperatures below -13 °F (-25 °C) for more than seven days can cause irreversible damage to the vehicle due to frost damage

Conditions of use

Observe the information on exceptions and limitations in the warranty documentation and in the Maintenance Booklet.

Voltage surge protection device

- !** Voltage surges in the mains supply can damage the vehicle. The vehicle is therefore equipped with a device which protects

it from voltage surges in the mains supply. This device may be triggered during severe thunderstorms, for example, and may lead to the building's fuse being tripped and an interruption in the power supply. These functions protect the vehicle. After the building fuse is switched on again, the charging process resumes automatically. Following an interruption in the power supply without the building's fuse being tripped, it may take up to 10 minutes for charging to resume automatically.

After the device has triggered, switch the building's fuse unit on again. Otherwise, the charging process will not resume.

Heat generated by the charging cable and charging cable connector

Charging cables and charging cable connectors may heat up during the charging process at a mains socket.

In the following cases, the rise in temperature is within the permitted limits:

- infrastructure of the mains power supply and the charging cable are intact
- instructions for handling the charging cable and controls on the charging cable are followed

If an increase in temperature to above the permitted limits does take place, check the infrastructure of the mains power supply.

Understanding the vehicle socket

Overview vehicle socket

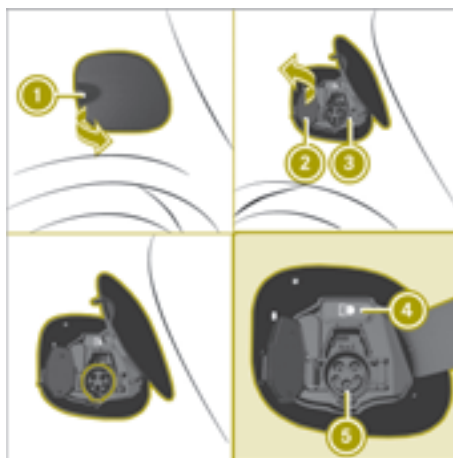

- ① Charge socket flap
- ② Socket cap
- ③ Catch
- ④ Indicator lamp
- ⑤ Vehicle socket

Indicator lamp on the vehicle socket

The indicator lamp on the vehicle socket has the following meaning:

Indicator lamp

Flashes green slowly	High-voltage battery is being charged.
Lights up green	High-voltage battery is fully charged.
Flashes orange slowly	Vehicle waiting for charging to start.
Flashes orange	Vehicle is paused from charging.
Flashes red quickly	A malfunction occurred during charging.

Charging the battery using a mains socket

Useful information

Charging cable

! Only use the charging cable to charge the high-voltage battery. Do not use the charging cable for other purposes. It may otherwise be damaged.

The charging cable for connection to a mains socket is included in the scope of delivery.

Only use the charging cable which is supplied with the vehicle and which has been approved by smart for this vehicle.

To transport, wrap the charging cable around the control panel or secure it to the housing of the control panel.

Control panel on charging cable

Do not leave the control panel on the charging cable hanging loose from a mains socket. Otherwise, this could lead to a bad contact with the mains socket and to malfunctions when charging the vehicle.

Do not lift up or transport the control panel by the charging cable connector or the mains plug.

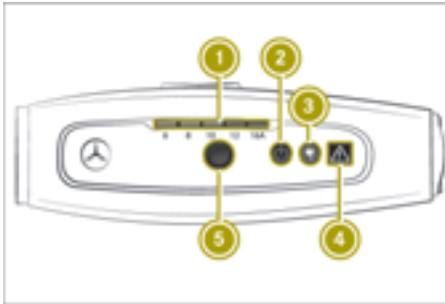

- ① Indicator lamp, charge current setting
- ② Indicator lamp, mains voltage
- ③ Indicator lamp, charging process
- ④ Indicator lamp, protection and control module
- ⑤ Button for setting the charge current

The indicator lamps on the charging cable have the following meaning:

Indicator lamp ①

Lights up green	Value is set as the desired charging current.
Flashes orange	Depending on the mains socket, the value cannot be set as the desired charging current.

Indicator lamp ②

Lights up green	Mains voltage is connected. The high-voltage battery can be charged.
-----------------	--

Indicator lamp ③

Lights up green	High-voltage battery is being charged.
Flashes orange	Connection to the vehicle is established.

Indicator lamp ④

Lights up red	The current at the control panel is not correct. The high-voltage battery cannot be charged.
---------------	--

Setting the charge current

⚠ WARNING

If the charge current draw via a mains socket is too high during the charging process, the external electrical system may overheat. There is a risk of fire.

Before beginning the charging process, check the maximum permissible charge current locally. Consult a qualified expert to do so where necessary.

If necessary, adjust your vehicle's settings.

! An excessive charge current can blow a fuse or lead to overheating of the external power supply. Check whether the external power supply is compatible with the set charge current. If necessary, lower the set

charge current or use another power socket.

The value of the charge current used to charge the high-voltage battery can be limited. This may protect the mains supply from overloads.

The maximum setting value and the adjustment values may vary from country to country.

The preset default value is the minimum setting. This is the minimum charge current available from the mains supply.

If the charging cable remains in the mains socket after charging, the value set will be adopted the next time you start charging. If the charging cable is disconnected from the mains socket, the value will be reset to the minimum setting the next time you start charging.

- ▶ Check the maximum permissible charge current for the particular mains socket.
- ▶ Plug the cable connector into the mains socket.
- ▶ Press button ⑤ repeatedly until the indicator lamp in the desired setting lights up green.
The desired value is set.

Connecting a charging cable

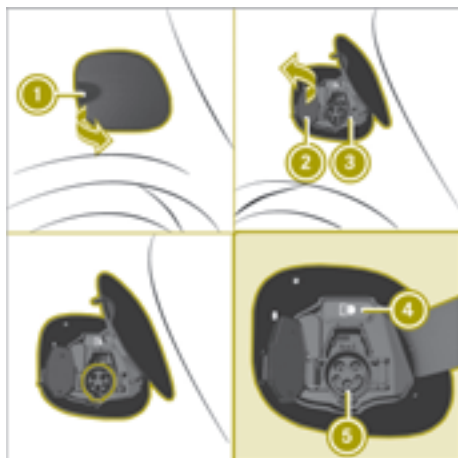

- ① Charge socket flap
- ② Socket cap
- ③ Catch

- ④ Indicator lamp
- ⑤ Vehicle socket

- ▶ Switch the ignition off.
- ▶ Engage transmission position **P**.
- ▶ Open charge socket flap ① (▷ page 64).
- ▶ Release lock ③ on socket cap ②.
Socket cap ② opens.
- ▶ Insert the mains plug into the mains socket as far as it will go.
- ▶ Set the desired charge current
- ▶ Insert the charging cable connector into vehicle socket ⑤ as far as it will go.
The high-voltage battery is being charged.

The high-voltage battery is fully charged when the **[E]** indicator lamp on the vehicle socket lights up green.

- i** The vehicle must not be moved during charging. The gear lever cannot be moved from position **P**.
- i** The engine cooling system and battery cooling system may audibly switch on during charging depending on the temperature.
- i** If charging the vehicle's high-voltage battery is taking longer than usual, check the maximum charge current settings.

Removing the charging cable

- [!]** Always disconnect the charging cable from the vehicle socket first. Disconnecting the charging cable from the stationary socket first could damage the charging cable connector.

The charging cable can be removed when the high-voltage battery is completely charged or charging has to be interrupted.

- ▶ Disconnect the charging cable from vehicle socket ⑤.
- ▶ Close socket cap ②.
- ▶ Close charge socket flap ①.
- ▶ Disconnect the charging cable from the mains socket.
- ▶ Stow the charging cable safely in the charging cable bag (▷ page 67).

Charging the battery at a charging station or wall box

Charging stations without communications functionality

Charging stations without communications functionality must be activated before charging, e.g. by using an RFID card. To do this, please observe the notes of the operator of the charging station.

Connecting a charging cable

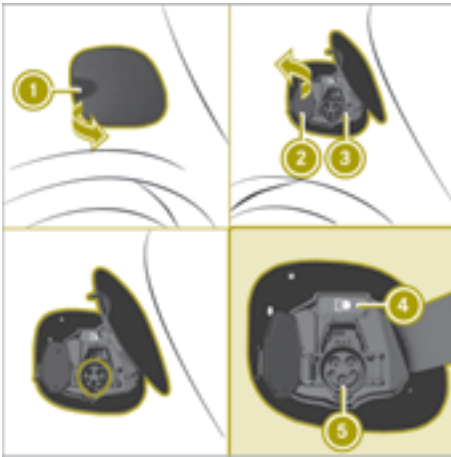

- ① Charge socket flap
- ② Socket cap
- ③ Catch
- ④ Indicator lamp
- ⑤ Vehicle socket

- ▶ Switch the ignition off.
- ▶ Engage transmission position **P**.
- ▶ Open charge socket flap ① (▷ page 64).
- ▶ Release locking mechanism ③ on socket cap ②.
Socket cap ② opens.
- ▶ Insert the charging cable connector into vehicle socket ⑤ as far as it will go.
The high-voltage battery is being charged.

- i** The vehicle must not be moved during charging. The gear lever cannot be moved from position **P**.

- i** The engine cooling system and battery cooling system may audibly switch on during charging depending on the temperature.

Removing the charging cable

- ▶ Press the button on the SmartKey.
The indicator lamp ④ above vehicle socket ⑤ goes out.
- ▶ Disconnect the charging cable from vehicle socket ⑤.
- ▶ Close socket cap ②.
- ▶ Close charge socket flap ①.

Storing the charging cable

- !** The charging cable must be stowed in the charging cable bag only to prevent it from being thrown around inside the vehicle.
- ▶ Stow the charging cable in the charging cable bag.

The charging cable bag is located in the trunk (▷ page 120).

Switching on the lighting

Useful information

The driver must ensure that the light settings match the current weather, light and traffic conditions.

For reasons of safety, smart recommends that you drive with the daytime driving lights or low beam headlamps switched on even during the daytime.

A warning tone sounds if the lights are still on when you leave the vehicle.

In some countries, operation of the headlamps varies due to legal requirements and self-imposed obligations.



- ① Combination switch control
- ② Marking

Activating automatic headlamp mode

WARNING

When the light switch is set to **AUTO**, the low-beam headlamps may not be switched on automatically if there is fog, snow or other causes of poor visibility due to the weather conditions such as spray. There is a risk of an accident.

In such situations, turn the light switch to .



While the engine is running, the light setting is selected automatically according to the brightness of the ambient light. **AUTO** controls the daytime running lights, parking lamps and low beam headlamps. The automatic headlamp feature is only an aid. The driver is responsible for the vehicle's lighting at all times.

- ▶ Turn combination switch control ① to the **AUTO** position.

If one or more of the following eventualities occurs, the lights are switched off automatically:

- the engine is switched off
- the driver's door is opened
- the vehicle is locked
- the high-beam headlamps are not switched on when the vehicle is stationary

Switching on the low-beam headlamps

- ▶ Turn combination switch control ① to the  position. The  indicator lamp lights up in the instrument cluster.

Switching the high-beam headlamps on or off



The engine must be running.

- ▶ Turn the combination switch control to the **AUTO** or  position.
- ▶ To switch on: press the combination switch in the direction of arrow ①.
- ▶ To switch off: move the combination switch back to its original position.

The  indicator lamp in the instrument cluster lights up when the high-beam headlamps are switched on.

Using the high-beam flasher

- ▶ Pull the combination switch in the direction of arrow ②.

Switching the parking lamps on

- ▶ Turn combination switch control ① to the  position.

Canada only: the parking lamps are only switched on when the engine is switched off. When the engine is running, the low beam headlamps are switched on.

Switching the fog lamps and rear fog lamp on and off

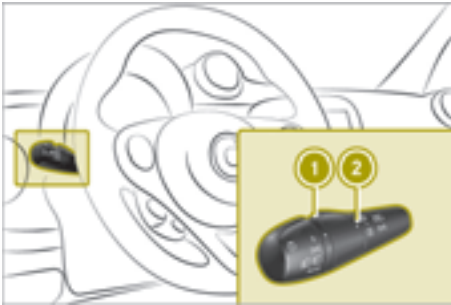

Only vehicles with front fog lamps are equipped with the "fog lamps" function.



- ① Combination switch middle ring
- ② Marking

The ignition and either the parking lamps or low beam headlamps must be switched on in order to switch the fog lamps on.

The engine must be started and either the parking lamps or low beam headlamps switched on in order to switch the rear fog lamp on.

- ▶ To activate or deactivate manually, turn combination switch middle ring ① to the desired marking:
 -  fog lamps
 -  rear fog lamp

After releasing, the combination switch middle ring returns automatically to the neutral position.

The fog lamps and rear fog lamp also go out automatically in the following situations:

- the lights are switched off
- the engine is switched off and the control is in the **AUTO** position

Using the cornering light function

Only vehicles with the LED & Sensor package are equipped with the cornering light function.

The cornering light function uses the front fog lamp to improve the illumination of the road in the direction in which you are turning, enabling better visibility in tight bends, for example.

The following conditions must be fulfilled for the cornering light function to switch on automatically:

- the low-beam headlamps are switched on
- the vehicle is moving at less than 25 mph (40 km/h)
- the turn signal is switched on or the steering wheel is turned

Using the interior lighting

Switching the interior lighting on and off

The interior lights go on when you unlock the doors.

The interior lights switch off in the following situations:

- a door is opened and 15 minutes have passed
- all doors are closed, the vehicle has been locked and 15 seconds have passed
- all doors are closed, the vehicle has not been locked and 4 minutes have passed
- the engine has been started

The interior lighting can be activated when a door is open. After closing the doors, the interior lighting goes out.



- ▶ Press switch ① to activate or deactivate the left-hand reading lamp.
- ▶ Move switch ② to the desired position:
 - interior lighting switched on
 - interior lighting controlled automatically
 - interior lighting switched off
- ▶ Press switch ③ to activate or deactivate the right-hand reading lamp.

Adjusting the ambient lighting (color display)

On-board computer with color display: the ambient lighting is set in the on-board computer (▷ page 86).

Using the windshield wiper

Switching on the windshield wiper

Please note

! Do not operate the windshield wipers when the windshield is dry, as this could damage the wiper blades. Moreover, dust that has collected on the windshield can scratch the glass if wiping takes place when the windshield is dry.

If it is necessary to switch on the windshield wipers in dry weather conditions, always use washer fluid when operating the windshield wipers.

! Vehicles with a rain sensor: if the windshield becomes dirty in dry weather conditions, the windshield wipers may be activated inadvertently. This could then damage the windshield wiper blades or scratch the windshield.

For this reason, you should always switch off the windshield wipers in dry weather.

! Make sure that the front windshield wipers are free of ice. The wiper motor could otherwise overheat.

Wiper blades are subject to wear and tear. smart recommends replacing the wiper blades twice a year. Worn or damaged wiper blades cause smearing on the windshield. On vehicles with a rain sensor, malfunctions are then possible.

Switching continuous wipe on and off



- ① Control for wipe frequency
- 0 Continuous wipe, off
- Automatic wipe
- 1 Continuous wipe, slow
- 2 Continuous wipe, fast
- Wiping with washer fluid

The ignition must be switched on in order to operate the windshield wiper.

- ▶ Press the combination switch down or up to the desired position.

Automatic wipe (vehicles with rain sensor)

The rain sensor is only an aid. The driver is responsible for ensuring good visibility at all times.

- ▶ Press the combination switch to the position. In automatic wipe mode, the appropriate wiping frequency is set according to the intensity of the rain.
- ▶ Use control ① to set the wipe frequency.

Switching on intermittent wiping

- ▶ Press the combination switch to the position.
- ▶ Use control ① to set the wipe frequency.



Wiping with washer fluid

- ▶ Pull the combination switch in the direction of arrow .

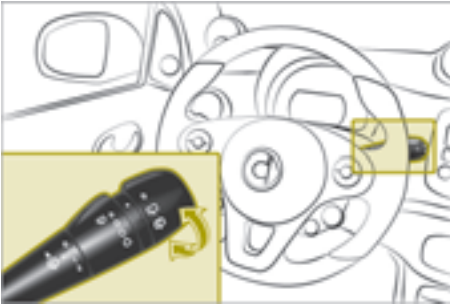
Switching the rear window wiper on and off (smart fortwo coupe)



To operate the rear window wiper, the ignition must be switched on.

- ▶ Turn the outer control on the combination switch to the desired position:
 - **0** Rear window wiper off
 -  Rear window wiper on
 -  Wipes with washer fluid

Switching the rear window wiper on and off when in reverse gear (smart fortwo coupe)

You can switch the "Automatic rear window wiper when reversing" setting on or off in the smart Media-System. The rear window wiper operates automatically for a short while when the ignition and the windshield wiper are switched on and reverse gear is engaged.

- ▶ In the smart Media-System, select **Vehicle > Settings > Auto rear wipe with reverse gear**.
The selected setting is highlighted.
- ▶ Confirm the setting with **Done**.

Folding the sun visor to the side

WARNING

If the mirror cover of the vanity mirror is folded up when the vehicle is in motion, you could be blinded by incident light. There is a risk of an accident.

Always keep the mirror cover folded down while driving.

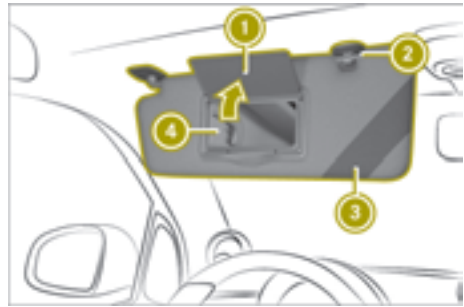

- ① Mirror cover
 - ② Bracket
 - ③ Retaining strap
 - ④ Vanity mirror
- ▶ Fold the sun visor down.
 - ▶ Pull the sun visor out of retainer ②.
 - ▶ Fold the sun visor to one side

Locking and unlocking the doors from the inside

Using the door handle to unlock the door



- ▶ Pull door handle ①.

If the vehicle has previously been locked with the SmartKey, opening a door from the inside will trigger the anti-theft alarm system. To disable the alarm, switch on the ignition.

Centrally locking and unlocking the vehicle from the inside

WARNING

If children are left unsupervised in the vehicle, they could:

- open the doors, thus endangering other people or road users.
- get out and disrupt traffic.
- operate the vehicle's equipment.

Additionally, children could set the vehicle in motion if, for example, they:

- release the parking brake.
- shifting the automatic transmission out of park position **P**
- Start the engine.

There is a risk of an accident and injury.

When leaving the vehicle, always take the SmartKey with you and lock the vehicle. Never leave children or animals unattended in the vehicle. Always keep the SmartKey out of reach of children.



- ▶ To lock: press button ①.
When the doors are locked, indicator lamp ② lights up.
- ▶ To unlock: press button ①.

Activating and deactivating the automatic locking feature

The activated automatic locking feature locks the vehicle automatically when the ignition is switched on and the vehicle is moving.

- ▶ When the engine is running, press and hold button ① for five seconds until a tone sounds.
When the automatic locking function is activated, the locking mechanism engages audibly when you pull away. When the automatic locking function is deactivated, no sound occurs.

Understanding the reversing feature

WARNING

The reversing feature does not react:

- to soft, light and thin objects, e.g. small fingers
- while resetting

This means that the reversing feature cannot prevent someone being trapped in these situations. There is a risk of injury. Make sure that no body parts are in close proximity during the closing procedure. If someone becomes trapped, press the switch to open the side window again.

The side windows are equipped with an automatic reversing feature. If a solid object blocks or restricts a side window from closing during automatic operation, the side window opens again automatically. During the manual closing process, the side window only opens again automatically after the corresponding switch is released. The automatic reversing feature is only an aid. The driver is responsible for operating the side windows safely.

Opening and closing the windows

Please note

WARNING

While closing the side windows, body parts in the closing area could become trapped. There is a risk of injury.

When closing make sure that no parts of the body are in the closing area. If somebody becomes trapped, release the switch or press the switch to open the side window again.

WARNING

If children operate the side windows they could become trapped, particularly if they are left unsupervised. There is a risk of injury.

When leaving the vehicle, always take the SmartKey with you and lock the vehicle. Never leave children unsupervised in the vehicle.

WARNING

If you close a side window again immediately after it has been blocked or reset, the side window closes with increased or maximum force. The reversing feature is then not active. Parts of the body could be trapped in the closing area in the process. This poses an increased risk of injury or even fatal injury.

Make sure that no parts of the body are in the closing area. To stop the closing proc-

ess, release the switch or push the switch again to reopen the side window.

The switches for both side windows are located on the driver's door. There is also a switch for the front-passenger window on the front-passenger door. The switch on the driver's door takes precedence.

Opening and closing the windows



① Left side window

② Right side window

- ▶ To open: press the switch.
- ▶ To close: pull the switch.

Opening and closing windows fully in automatic mode

- ▶ To open the windows fully, press the switch beyond the point of resistance and release it.
- ▶ To close the windows fully, pull the switch beyond the point of resistance and release it.
- ▶ To stop automatic operation, press the switch again.

Using the soft top (smart fortwo cabrio)

Please note

WARNING

During opening and closing of the folding top or rear soft top, body parts may become

trapped for example, by the roof mechanical system. There is a risk of injury.

Ensure that no parts of the body are in the immediate vicinity of moving parts during the closing or opening process. Release the switch immediately if somebody becomes trapped.

! When transporting long objects in the vehicle interior when the folding top is closed, make sure that the objects do not push against the folding top.

When transporting objects that protrude out of the rear of the vehicle, make sure that the objects do not rest on the rear soft top latch (bracket). Make sure that no sharp edged parts come into contact with the soft top or the rear window during loading.

Do not place flatly distributed loads with a weight of more than 75 kg on the folded down rear soft top.

Make sure that the high-mounted brake lamp is not covered.

! Do not obstruct the latch openings of the soft top system. Stow the side bars only in the designated stowage well of the tailgate.

! Make sure that objects are not stacked too high in the cargo compartment. They may be damaged when the rear soft top is opened or closed.

The procedure for removing, installing and stowing the side bars is described below. The QR code is a link to a video clip that demonstrates the procedure.



Opening and closing the soft top



To open or close the soft top, the ignition must be switched on.

- ▶ To open: press the switch to position ② until the soft top is in the desired position. Press switch ② again to fully open the soft top.
- ▶ To close: press the switch to position ① until the soft top is in the desired position.

It is possible to open or close the soft top while driving up to the maximum design speed. In poor weather and at high speeds, it is possible that electric locking when closing is not reliable. If this is the case you must reduce the speed and, if necessary, press the switch again to close the soft top.

Opening the soft top (using the SmartKey)

- ▶ Press and hold the  button on the SmartKey.

Removing the side bars

- ▶ Open the soft top
- ▶ Open the doors and tailgate.

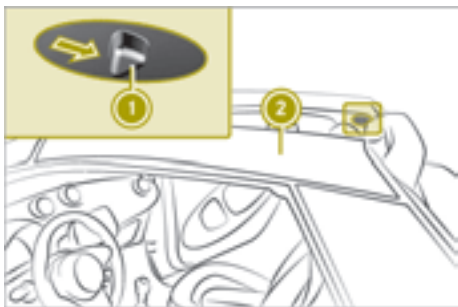

- ▶ To release: slide lever ① back. The side bar is unlocked.
- ▶ Push lever ① back again and remove side bars ②.

Stowing the side bars

WARNING

If you transport the side bars without securing them, they may be thrown around in the event of an accident, braking or sudden changes in direction. There is a risk of injury.

Always stow the side bars in the designated stowage well and close the stowage well lid.

! When the soft top is folded down, theft of the side bars is possible. Therefore, remove the side bars and stow them in the cargo compartment or close the soft top.

! If you load the stowage space it could be damaged.

Never stow heavy objects on the stowage space or sit on it.

Please note:

- only use the stowage space to store the side bars
- always place both side bars in the stowage space

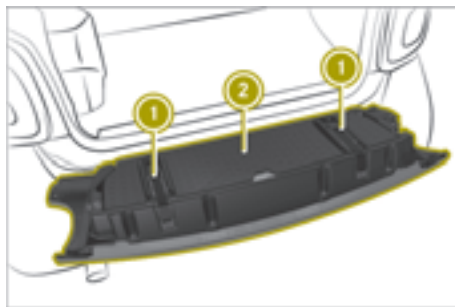

Observe the notice on the stowage well.

- ▶ Release fastening straps ① on the stowage space and guide the locking mechanism with your hand until the fastening straps are released.
- ▶ Open cover ②.
- ▶ Store the side bars as shown (observe markings L and R on the side bars and the stowage compartment for the left and right side bars):

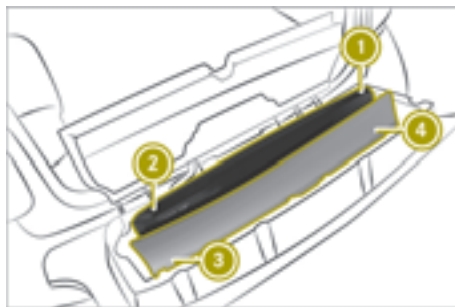
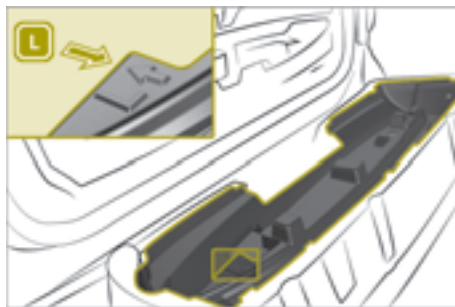

- ① Side bar, front left
- ② Side bar, rear left
- ③ Side bar, front right
- ④ Side bar, rear right

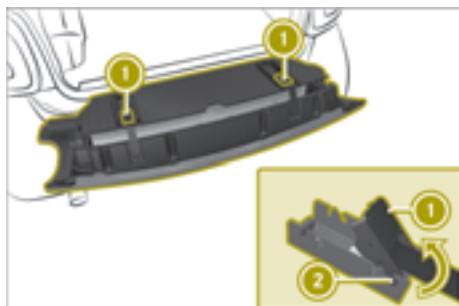

- ▶ Close the cover.
The cover must audibly engage.
- ▶ Secure both fastening straps with tensioner ① on rear detent ②.
The red surfaces at the side must no longer be visible. An audible click can be heard upon engaging.
- ▶ Close the tailgate.
- ▶ If the tailgate does not close properly, check if the side bars have been stored as specified.

Mounting the side bars

WARNING

If the side bars are incorrectly mounted they may become loose during the journey and endanger other road users. There is a risk of an accident and injury.

Mount the side bars as described.

- ▶ Open the doors and tailgate.
- ▶ Release the fastening straps on the stowage space and guide the locking mechanism with your hand until the fastening straps are released.
- ▶ Open the cover.
- ▶ Remove the side bars.

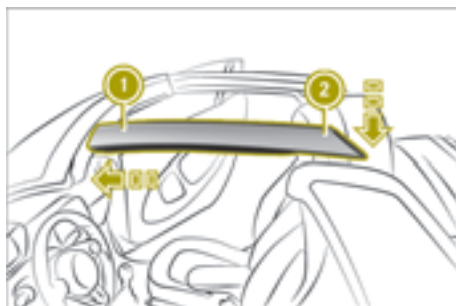

- ▶ Insert the side bar from the stowage compartment marked L on the left side at front end ①.
- ▶ Press down rear end of side bar ② until it engages twice.
- ▶ Install the side bar from the stowage compartment marked R on the right-hand side.

Closing the stowage well without the side bars

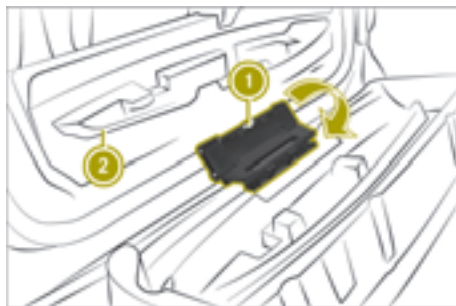

- ▶ Move folding mechanism ① in the direction of the arrow.
- ▶ Close cover ②.

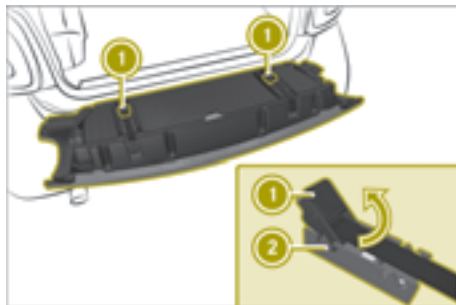

- ▶ Secure both fastening straps with tensioner ① on front detent ②.
The red surfaces at the side must no longer be visible. An audible click can be heard upon engaging.
- ▶ Close the tailgate.

Operating the climate control system

Useful information

The climate control system is only available when the ignition is switched on.

If the climate control system is deactivated, the air supply and circulation are switched off. The windows could fog up. You should therefore switch off the climate control system for brief periods only.

In air-recirculation mode, only the air inside the vehicle is recirculated and no fresh air is introduced. This is useful in a tunnel or when there are unpleasant odors outside the vehicle. In air-recirculation mode, the windows may fog up more quickly, particularly when the outside temperature is low. Therefore, switch on air-recirculation mode only briefly.

The integrated filter in the climate control system keeps out most particles of dust as well as pollen. The filter reduces the amount of air supplied to the vehicle interior. For this reason, you should always observe the interval for replacing the filter.

Operating the automatic climate control

Switching the automatic climate control system on and off

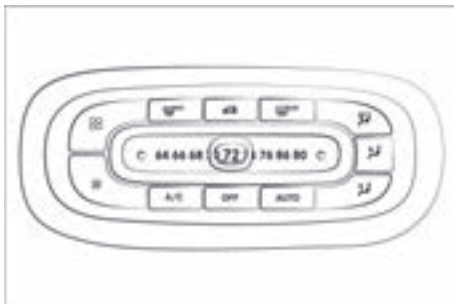

The ignition must be switched on in order to operate the blower. The engine must be running in order to operate all the functions of the automatic climate control system.







- ▶ To switch on: press the **AUTO** button.
The indicator lamps below **AUTO** and **A/C** light up.
- ▶ To switch off: press the **OFF** button.
The indicator lamp below **OFF** lights up.

Setting the temperature

- ▶ Move the slider in small increments to the left or right.

In automatic mode, the set temperature is maintained at a constant level. The air distribution and blower speed are regulated automatically.

Switching the air distribution on and off

- ▶ Press one or more of the , ,  buttons.
 -  Defroster vents
 -  Center and side air vents
 -  Footwell vents



Increasing the blower speed

- ▶ Press the  button.

Decreasing the blower speed

- ▶ Press the  button.



Activating/deactivating air-recirculation mode

- ▶ Press the  button.
The indicator lamp above  lights up when air-recirculation mode is activated.

Switching "Cooling with air dehumidification" on or off

The "Cooling with air dehumidification" function cools and dehumidifies the air inside the vehicle during warm weather.

The engine must be running in order to use "Cooling with air dehumidification".

- ▶ To switch on: press the  and  button.

The indicator lamp below  lights up when the function is activated.

In damp weather switch off the "Cooling with air dehumidification" function only briefly. Otherwise the windows will fog up faster.

Defrosting the windshield

- ▶ Press the  button.

The indicator lamp above  lights up when the windshield is being defrosted.

Use this setting only until the windshield is clear again.

Defrosting the rear window



When the rear window defroster is activated, the exterior mirrors are also heated.

- ▶ Press the  button.

The indicator lamp above  lights up when the rear window defroster is activated.

Use this setting only until the rear window is clear again.

Drying windows that are fogged up on the inside

- ▶ Press the  button.
- ▶ Press the  button.
- ▶ If the windows are still fogged up, press the  button.

Use this setting only until the windows are clear again.

Drying windows that are fogged up on the outside

- ▶ Switch on the windshield wipers.
- ▶ Press the  button.

Use this setting only until the windows are clear again.

Setting the pre-entry climate control at departure time using the on-board computer

The "Pre-entry climate control at departure time" function" heats or cools the vehicle

interior before the scheduled departure time. The climate control runs until approx. 10 minutes after the set departure time.

The vehicle must be connected to the charger in order to activate pre-entry climate control. The battery charge and the charge output of the high-voltage battery must be sufficient.

If pre-entry climate control cannot be operated, a display message is shown in the on-board computer.

- ▶ Call up **Pre-ent. Clim. Ctrl. & Charge** in the on-board computer.
- ▶ Press .
- ▶ Select one of the following settings:

- **no Preselection**

The pre-entry climate control is deactivated.

- **Two stored departure times**

- ▶ Departure time > select **Activate** to activate the stored departure time.
- ▶ Departure time > select **Change** to change the settings of a stored departure time.
- ▶ Set the value

- ▶ **i** If **instant charging** is selected, the high-voltage battery is charged regardless of the cost information. A part of the charging may not be conducted until one to two hours before the departure time, in order for temperature control of the high-voltage battery to be carried out for the intended departure time.

Setting the air vents

Please note

WARNING

Very hot or very cold air can flow from the air vents. This could result in burns or frostbite in the immediate vicinity of the air vents. There is a risk of injury.

Make sure that all vehicle occupants always maintain a sufficient distance to the air outlets. If necessary, redirect the airflow to another area of the vehicle interior.

⚠ WARNING

If you spray cleaning products or disinfectant into the ventilation system of the vehicle, this could ignite. There is a risk of fire.

Never spray these or any other substances into the ventilation system. Always have work on the ventilation system carried out at a qualified specialist workshop.

Keep the following rules in mind for optimal climate control:

- Keep the air slots between the service cover and windshield clear of blockages.
- Do not cover the vents or ventilation grilles in the vehicle interior.
- Open the air vents fully.

Opening and closing the air vents

- ▶ To open: turn vent **1** outwards.
- ▶ To close: turn vent **2** inwards.

Directing the air vents

- ▶ Turn the air vents upwards, downwards, to the left or to the right as desired.

Activating/deactivating the seat heating and steering wheel heating**⚠ WARNING**

Repeatedly switching on the seat heating can cause the seat cushion, the backrest pad and parts of the steering wheel to become very hot. The health of persons

with limited temperature sensitivity or a limited ability to react to higher temperatures may be affected or they may even suffer burn-like injuries. There is a risk of injury.

Therefore, do not switch the seat heating on repeatedly.



The seat heating only works when the ignition is switched on. Vehicles with the Winter package are additionally equipped with the "Steering wheel heating" **1** function.

- ▶ Press button **3**.
- Indicator lamp **2** lights up when seat heating is activated.

Vehicles with the Winter package: steering wheel heating **1** is also switched on when the driver's seat heating is activated.

Using the accessories**Using the cigarette lighter****⚠ WARNING**

You can burn yourself if you touch the hot heating element or the socket of the cigarette lighter.

In addition, flammable materials can ignite if:

- the hot cigarette lighter falls
- a child holds the hot cigarette lighter to objects, for example

There is a risk of fire and injury.

Always hold the cigarette lighter by the knob. Always make sure that the cigarette

lighter is out of reach of children. Never leave children unsupervised in the vehicle.

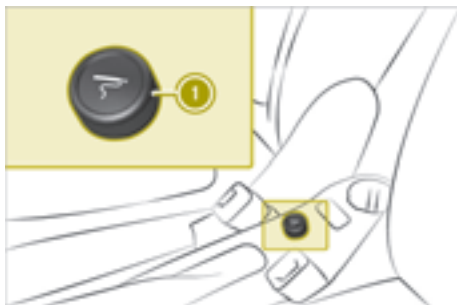

The cigarette lighter only works when the ignition is switched on.

- ▶ Press cigarette lighter ①.
When cigarette lighter ① is hot, it pops up automatically.

Using the ash tray

! The cup holder in the center console is not heat resistant. Before placing lit cigarettes in the ashtray, make sure that the ashtray is fully inserted in the cup holder. Make sure that lit cigarettes do not fall into the cup holder.

Otherwise, the cup holder could be damaged.



- ▶ To open: lift up cover ①.
- ▶ To close: push down cover ①.
- ▶ To remove: pull the ashtray up and out.
- ▶ To insert: insert the ashtray into the cup holder.

Using the 12 V socket

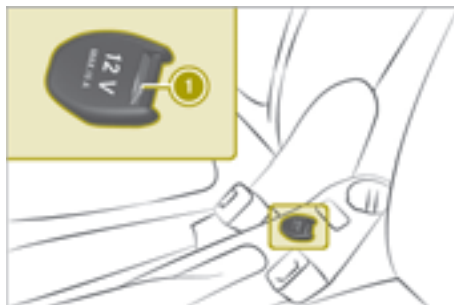

- ▶ Turn the SmartKey to position ① in the ignition lock.
- ▶ Lift up the cover of socket ①.
- ▶ Connect device.

The socket can be used for accessories up to a maximum draw of 120 W (15 A).

If you use the socket for very long periods when the engine is switched off, the 12 V battery may discharge.

Installing and removing the floor mats

! WARNING

Objects in the driver's footwell can restrict the pedal travel or obstruct a depressed pedal. The operating and road safety of the vehicle is jeopardized. There is a risk of an accident.

Make sure that all objects in the vehicle are stowed correctly, and that they cannot enter the driver's footwell. Install the floor mats securely and as specified in order to ensure sufficient clearance for the pedals. Do not use loose floor mats and do not place floor mats on top of one another.



- ▶ Slide the driver's seat backward.
- ▶ To install: press securing knobs ① onto retainers ②.
- ▶ To remove: release securing knobs ① from retainers ②.

Parking

Please note

WARNING

The automatic transmission switches to neutral position **N** when you switch off the engine. The vehicle may roll away. There is a risk of an accident.

Before switching off the engine, always switch to parking position **P**. Prevent the parked vehicle from rolling away by applying the parking brake.

-  Always secure the vehicle correctly against rolling away. Otherwise, the vehicle or its drivetrain could be damaged.

Switching off the engine

- ▶ Apply the parking brake.
- ▶ Shift the transmission to position **P**.
- ▶ Turn the SmartKey to position **0** in the ignition lock and remove it.
- ▶ On steep uphill or downhill gradients, turn the front wheels towards the curb.

Locking the vehicle

WARNING

If children are left unsupervised in the vehicle, they could:

- open the doors, thus endangering other people or road users.
- get out and disrupt traffic.
- operate the vehicle's equipment.

Additionally, children could set the vehicle in motion if, for example, they:

- release the parking brake.
- shift the transmission out of park position **P**
- start the vehicle's drive system.

There is a risk of an accident and injury.

When leaving the vehicle, always take the SmartKey with you and lock the vehicle. Never leave children or animals unattended in the vehicle. Always keep the SmartKey out of reach of children.

- ▶ Press the  button on the SmartKey. The turn signals flash twice.

Locking is confirmed by an audible signal.

Arming and disarming the anti-theft alarm system

Useful information

The immobilizer prevents the vehicle from being started without the correct SmartKey. It is switched on and off automatically.

The anti-theft alarm system triggers a visual and audible alarm if a door, the tailgate or the service cover is opened.

The alarm is not switched off, even if, for example, you close the open door that has triggered it.

Arming

- ▶ Close the doors.
- ▶ Close the tailgate.
- ▶ Close the service cover.
- ▶ Press the  button on the SmartKey. The alarm system is armed after approximately 30 seconds.

Disarming and switching off the alarm

- ▶ Press the  button on the SmartKey.

Overview of the on-board computer

Please note

⚠ WARNING

If you operate information systems and communication equipment integrated in the vehicle when driving, you may be distracted from the traffic situation. You could also lose control of the vehicle. There is a risk of an accident.

Only operate this equipment when the traffic situation permits. If you are not sure that this is possible, park the vehicle paying attention to traffic conditions and operate the equipment when the vehicle is stationary.

⚠ WARNING

If the instrument cluster has failed or malfunctioned, you may not recognize function restrictions in systems relevant to safety. The operating safety of your vehicle may be impaired. There is a risk of an accident.

Drive on carefully. Have the vehicle checked at a qualified specialist workshop immediately.

If the operating safety of your vehicle is impaired, you must park the vehicle safely as soon as possible. Consult a qualified specialist workshop.

The outside temperature is displayed on the far right in the top bar. Drivers must pay special attention to road conditions when temperatures are around freezing point. Changes in the outside temperature are displayed after a short delay.

After opening the door, the on-board computer is activated for approximately 15 minutes. To permanently activate the on-board computer, the ignition must be switched on.

Color display overview

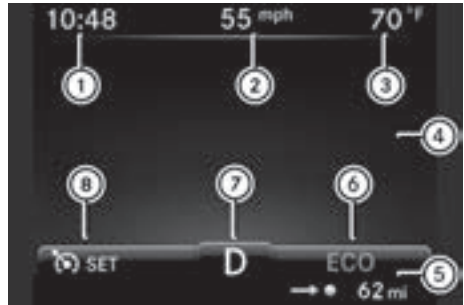

- ① Time
- ② Digital Speedometer
- ③ Outside temperature display
- ④ Display field for display messages, menus and lists
- ⑤ ECO mode
- ⑥ Remaining range
- ⑦ Transmission display
- ⑧ Cruise control





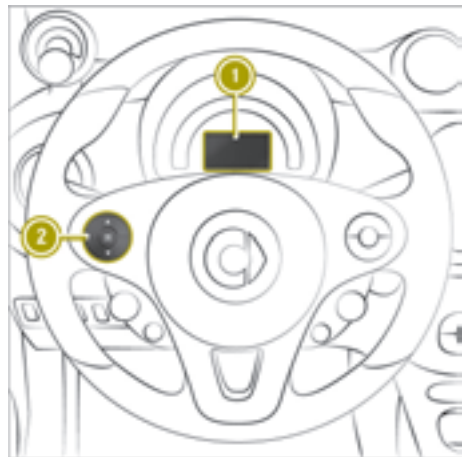

Calling up displays

Calling up displays (color display)

Calling up displays



- ① Color display
- ② Left control panel

- ▶ Briefly press  or  on left control panel , to scroll forward or back.
- ▶ Press and hold  or  on left control panel , to directly call up the **Distance** display.

The following displays can be called up one after another:

- **Distance**
- Trip computer **From Start**
- Trip computer **From Reset**
- **eco score From Start**
- **Fuel consumption bar chart**
- **Energy Flow**
- **Pre-ent. Clim. Ctrl & Charge**
- **Messages and Service**
- **Settings**
- **Digital Speedometer**

Distance display

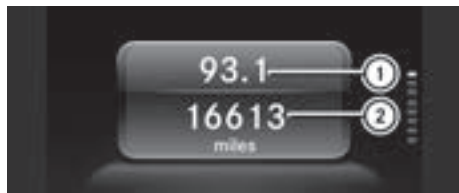

- ① Trip odometer
- ② Odometer

Trip computer display

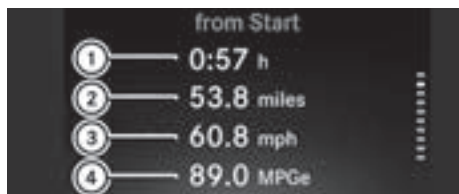

- ① Elapsed time
- ② Distance
- ③ Average speed
- ④ Average energy consumption

The data in the **From Start** menu refers to the start of the journey, whilst the data in the **From Reset** menu refers to the last time the submenu was reset.

If the ignition remains switched off for longer than four hours, the **From Start** values in the instrument cluster are reset.

eco score display



The eco score display provides feedback on how economical the driver's driving behavior is (> page 57).

If the ignition remains switched off for longer than four hours, the eco score display will be automatically reset.

When the eco score display is reset, the **From Start** trip computer in the smart Media-System and the eco score display are also reset in the smart Media-System.

Fuel consumption bar chart display



- ① Energy consumption
- ② Energy recuperation

The display shows the average energy consumption and the energy recuperation over the previous 15 minutes.

Energy flow display



- ① Total output
- ② Output for electrical consumers

The total output shows the driver the sum of the energy currently flowing from the battery. The color of the battery shows whether energy is being consumed or recuperated:

- Battery symbol is orange: energy is being consumed.
- Battery symbol is green: energy is being recuperated.
- Battery symbol is gray: energy consumption and energy recuperation are equally high or both 0 kW.

The output for electrical consumers shows the driver what output is needed to operate electrical consumers such as climate control systems or the radio. A greater range is achieved if the value is kept as low as possible.

Pre-entry climate control and charging display



- ① Time of the full charge
- ② Condition of charge of the battery
- ③ Departure time
- ④ Smart-Charging
- ⑤ Charge current and charge output

An arrow underneath the battery indicates the condition of charge of the battery at the departure time. The condition of charge and the time of complete charge are only predicted approximately. The moment at which charging is completed cannot be displayed when Smart-Charging is activated.

Information on the "Pre-entry climate control at departure time" function (▷ page 78).

Messages and service display

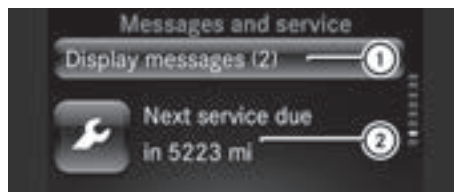

- ① Message memory
- ② Next service due date

The display shows the number of display messages in the message memory and the next service due date.

indicates a minor service. indicates a major service.

To show the display messages, the ignition must be switched on.

- ▶ Press **OK** to scroll through the display messages.

Current information on the type of service can be obtained at a smart center or a qualified specialist workshop.

Digital speedometer display

The display shows the digital speedometer. The digital speedometer in the header is hidden.

Setting values

Setting values (color display)

Setting values

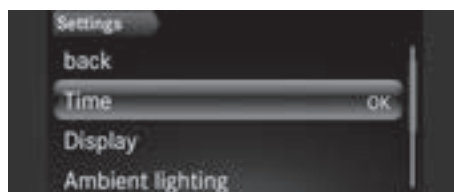

- ▶ Press or to scroll to **Settings**.
- ▶ Press or to scroll to the desired menu.
- ▶ Press or to set the desired data.
- ▶ Press **OK** to confirm.

Resetting values

- ▶ Press **OK**.
- ▶ Select **yes** and press **OK** to confirm.

Setting the time

- ▶ Select **Settings > Time > Set the Time**.
- ▶ Set values

Setting the time format

- ▶ Select **Settings > Time > Time Format**.
- ▶ Set the value

Adjusting the instrument cluster lighting

- ▶ Select **Settings > Display > Display Brightness**.
- ▶ Set the value

Displaying the digital speedometer in the header

- ▶ Select **Settings > Display > Digital Speedometer**.
- ▶ Select the **Display Speedometer** function. The digital speedometer is displayed in the header.

Setting the unit for speed in the digital speedometer

- ▶ Select **Settings > Display > Digital Speedometer > Unit**.
- ▶ Set the value
The following values are set:
 - Digital speedometer display
 - Digital speedometer in the header

Setting the unit of measurement for distance

- ▶ Select **Settings > Display > Units of Distance**.
- ▶ Set the value

Setting the temperature unit

- ▶ Select **Settings > Display > Units of Temperature**.
- ▶ Set the value

Starting the tire pressure monitor

- ▶ Select **Settings > Tire Pressure Monitor**.
Information on the tire pressure monitor ([▷](#) page 138).

Switching the ambient lighting on/off

- ▶ Select **Settings > Ambient Lighting > On**.

Setting the brightness of the ambient lighting

- ▶ Select **Settings > Ambient lighting > Brightness**.
- ▶ Set the value

Setting the language

- ▶ Select **Settings > Language (Language)**.
- ▶ Set the value

Operating and setting the smart Audio-System

smart Audio-System overview







WARNING

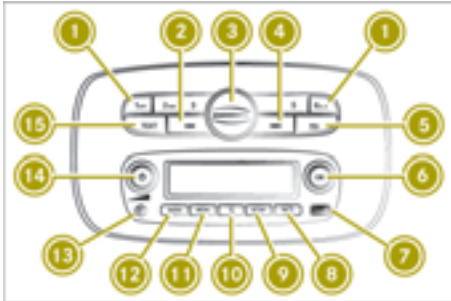

If you operate information systems and communication equipment integrated in the vehicle when driving, you may be distracted from the traffic situation. You could also lose control of the vehicle. There is a risk of an accident.

Only operate this equipment when the traffic situation permits. If you are not sure that this is possible, park the vehicle paying attention to traffic conditions and operate the equipment when the vehicle is stationary.



You must observe the legal requirements for the country in which you are currently driving when operating the smart Audio-System.



- ① Number keys **1** - **6**
- ②  Previous station or track
- ③ USB1 port and bracket connection for mobile phone with smart cross connect app
- ④  Next station or track
- ⑤  Goes back one menu level higher
- ⑥ Control for menu selection and station list, **OK** button
- ⑦ USB2 connection
- ⑧  Telephone menu, to accept or reject calls
- ⑨  System settings
- ⑩  Mute
- ⑪  Plays back media from external data carriers

- ⑫  Switches on the radio and selects the waveband.
- ⑬ External audio equipment (AUX jack)
- ⑭ Volume control,  button
- ⑮  Sets the radio text

Operating and setting the smart Audio-System

- ▶ To switch on or off: press .
- ▶ To scroll through menus: turn control **6**.
- ▶ To select menu options: turn control **6** and press the **OK** button.
- ▶ To navigate to the next-highest folders: press the .
- ▶ To set values: turn control **6** and press the **OK** button.
- ▶ To increase or decrease the volume: turn control **14**.

Using external devices

Useful information

You can connect the following external devices:

- USB devices, iPods® and MP3 players (USB port)
- External audio equipment (AUX jack)
- Bluetooth® devices, such as mobile phones

Removing the cover of the USB1 connection and securing it

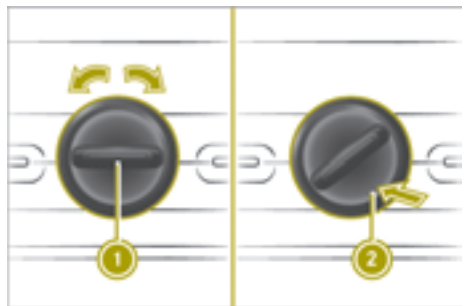

Removing the cover

- ▶ Turn handle ① on the cover counter-clockwise.
- ▶ Press on marking ②.
- ▶ Remove the cover.

Fastening the cover

- ▶ Place cover in position ②.
- ▶ Turn the cover clockwise using handle ①.

Using the smartphone bracket

Useful information

- i** Operating smartphones in the smartphone bracket is permitted exclusively in connection with the smart cross connect App.

The smartphone bracket keeps your mobile phone secured in the vehicle. In order to use the smart cross connect App, rotate the mobile phone to landscape mode.

You can use the USB port behind the smartphone bracket on the left to charge your mobile phone during the journey.

The smartphone bracket is suitable for mobile phones with the following dimensions:

- Thickness: 0.24 – 0.39 in (6 – 10 mm)
- Width: 2.17 – 3.23 in (55 – 82 mm)
- Length: 4.72 – 6.38 in (120 – 162 mm)

Further information is available from any smart center.

Installing the smartphone bracket

- ▶ Remove the cover from the USB1 port.
- ▶ Connect the smartphone bracket to USB1 and turn the fastener to clockwise.

Inserting and removing the mobile phone

- ▶ **To insert:** press the right-hand raised button on the bottom edge of the smartphone bracket.
The upper tensioning arm opens.
- ▶ If necessary, press the left-hand button on the bottom edge of the smartphone bracket.
The tensioning arms on the side open.

- ▶ Set the mobile phone in the smartphone bracket.
- ▶ If necessary, press the tensioning arms on the side together to set them to the size of the mobile phone.
- ▶ Press down the upper tensioning arms to secure the mobile phone.
- ▶ **To remove:** press the right-hand raised button on the bottom edge of the smartphone bracket.
The upper tensioning arm opens.
- ▶ Remove the mobile phone from the smartphone bracket.

Operating the smart Audio-System via the mobile phone

You can use the smart cross connect App for iOS and Android to operate the smart Audio-System via a mobile phone.

- ▶ Download the smart cross connect App from the App Store® (iOS) or Google Play™ (Android) and install it on the mobile phone.
- ▶ Connect the mobile phone with the smart Audio-System via Bluetooth®.
- ▶ Insert the mobile phone into the bracket.

Further information about operating the smart Audio-System via mobile phone can be found in the smart cross connect App user's guide.

Adjusting the system settings

Setting the system language

- ▶ Press the **SETUP** button.
- ▶ Select **Language**.
The list of languages appears.
- ▶ Select the language.

Switching the time on or off

- ▶ Press the **SETUP** button.
- ▶ Select **Clock**.
- ▶ Select **ON** or **OFF**.

Setting the time

- ▶ Press the **SETUP** button.
- ▶ Select **Clock**.
- ▶ Select **Set Time**.
- ▶ Set the time.

Setting the time format

- ▶ Press the **SETUP** button.
- ▶ Select **Clock**.
- ▶ Select **Format**.
- ▶ Choose one of the following time formats:
 - **Am/Pm**
 - **24hr**

Adjusting the audio settings

Adjusting the sound

- ▶ Press the **SETUP** button.
- ▶ Select **Audio**.
- ▶ Select **Sound**.
- ▶ Select the desired sound settings:
 - **Bass**: adjusts the bass.
 - **Treble**: adjusts the treble.
 - **Bal.**: adjusts the surround sound (balance) to left or right.

Switching Bass Boost on or off (vehicles without JBL sound system)

- ▶ Press the **SETUP** button.
- ▶ Select **Audio**.
- ▶ Select **Bass Boost**.
- ▶ Select **ON** or **OFF**.

Resetting audio settings

- ▶ Press the **SETUP** button.
- ▶ Select **Audio**.
- ▶ Select **Audio Default**.
- ▶ Select **Yes**.

Adjusting the volume to the vehicle speed (vehicles without JBL sound system)

- ▶ Press the **SETUP** button.
- ▶ Select **Audio**.
- ▶ Select **Speed Vol.**
- ▶ Select the desired level.
The higher the level, the higher the volume will be at increasing road speeds.

Listening to the radio

Switching on the radio

- ▶ Press the **POWER** button.
- ▶ Press the **RADIO** button.

The smart Audio-System receives data transmitted via the Radio Data System (RDS).

Selecting a waveband

- ▶ Press the **RADIO** button repeatedly until the desired waveband appears.

If available, you can switch between the following wavebands:

- FM1
- FM2
- AM

Selecting stations manually

- ▶ Press the **SKIP** or **PREV** button to set the desired frequency.

Holding down the **SKIP** or **PREV** button starts the station search, which stops at the next station with adequate reception.

Setting a station from the station list

- ▶ Press **OK** in radio mode.
The station list appears.
- ▶ Select a station.
- ▶ Press **OK** to confirm.

Updating the station list

- ▶ Press the **RADIO** button until you hear a tone.

Storing a station

- ▶ Select a waveband.
- ▶ Set the station.
- ▶ Press a number key **1** to **6** until you hear a tone.
The station set for this waveband will be saved at the button you have pressed.

Selecting a stored station

- ▶ Select a waveband.
- ▶ Press a number key for the stored station.

Switching traffic announcements on/off

- ▶ Press the **SETUP** button.
- ▶ Select **Radio**.
- ▶ Select **TA**.
- ▶ Select **ON** or **OFF**.

Interrupting a traffic announcement

- ▶ During a traffic announcement, briefly press **←**.

Displaying radio text in FM radio

- ▶ Press the **TEXT** button.
If radio text is available, it will be displayed.

Using a mobile phone

Connecting a mobile phone

Useful information

The Bluetooth®-capable mobile phone must be compatible with the smart Audio-System.

Overview of compatible mobile phones:
<http://www.smart.com/connect>.

To make a call, Bluetooth® must be activated on the mobile phone and the smart Audio-System.

Once outside the Bluetooth® reception range, the connection is terminated automatically.

To clearly identify a mobile phone, change the device name (see the manufacturer's operating instructions).

Activating Bluetooth® on a mobile phone

- ▶ Activate Bluetooth® on the mobile phone (see the manufacturer's operating instructions).
- ▶ Search for devices.

Switching on the Bluetooth® function of the smart Audio-System

- ▶ Press the **TEL** button.
- ▶ Turn control **6** to **Bluetooth** and confirm with **OK**.
- ▶ Turn control **6** to **ON** and confirm with **OK**.
The **●** dot shows the active setting.

Authorizing a mobile phone on the smart Audio-System

- ▶ Press the **TEL** button.
- ▶ Select **Scan devices**.
The system searches for available mobile phones and displays them in a list.
- ▶ Select the mobile phone and confirm with **OK**.
- ▶ Do one of the following:
 - If a code appears in the smart Audio-System display and on the mobile phone, confirm it on the mobile phone.
 - If the code **0000** appears in the smart Audio-System display, enter it and confirm it on the mobile phone.

A maximum of five mobile phones can be authorized. However, only one authorized mobile phone can be connected with Bluetooth® at a time.

Loading and updating the telephone book

- ▶ Press the **TEL** button.
- ▶ Select **Settings > PB download**.
- ▶ If necessary, accept the access confirmation on the mobile phone.

If the mobile phone supports the Bluetooth® PBAP (Phone Book Access Profile) profile, the phone book and call lists will be transferred after you connect.

Removing a mobile phone from the list (de-authorizing)

- ▶ Press the **TEL** button.
- ▶ Select **Del. device**.
Authorized mobile phones are displayed.
- ▶ Select the mobile phone to be removed.
- ▶ Select **Yes**.

After de-authorization, the Bluetooth® connection to the mobile phone is no longer established automatically.

Connecting another authorized mobile phone

- ▶ Activate Bluetooth® on a mobile phone
- ▶ Press the **TEL** button.
- ▶ Select **Sel. device**.
All authorized mobile phones are displayed. The currently connected mobile phone is indicated by a dot.
- ▶ Select the desired mobile phone from the list.

Setting the sound

Adjusting the call volume

- ▶ Press the **TEL** button.
- ▶ Select **Settings > Volume > Call**.
- ▶ Select the setting.

Switching the smart Audio-System ringtone on and off

- ▶ Press the **TEL** button.
- ▶ Select **Settings > Ringtone**.

- ▶ To switch on: select **Car**.
- ▶ To switch off: select **Phone**.

Adjusting the ring tone volume

- ▶ Press the **TEL** button.
- ▶ Select **Settings > Volume > Ring**.
- ▶ Select the setting.

Using the telephone

Calling a contact from the phone book

To call a contact in the telephone book, the mobile phone telephone book first has to be imported into the smart Audio-System.

- ▶ Press the **TEL** button.
- ▶ Select **Telephone book**.
- ▶ Select the contact.
The details for the contact are displayed.
- ▶ Dial the desired phone number.
- ▶ Press the **OK** button.

Dialing a number

- ▶ Press the **TEL** button.
- ▶ Select **Dial Number**.
An input screen appears.
- ▶ Enter the number.
- ▶ Press the **OK** button.
- ▶ Select .

Using call lists to call contacts

To call a contact in a call list, the mobile phone telephone book first has to be imported into the smart Audio-System.

- ▶ Press the **TEL** button.
- ▶ Select **Call lists**.
- ▶ Select **Dialed, Received** or **Missed**.
- ▶ Select an entry from the list.

Calling the last number dialed

- ▶ Press and hold the **TEL** button until the call is established.

Accepting a call

- ▶ Press the **[TEL]** button.

Rejecting a call

- ▶ Press and hold the **[TEL]** button until the call is rejected.

Holding and continuing a call

- ▶ To place a call on hold: select **[⏸]**.
- ▶ To continue the call: press the **[OK]** button.

Transferring a call to the mobile phone

- ▶ Select **[☎]**.
- ▶ To transfer the call back to the smart Audio-System: press **[OK]**.

Entering numbers or characters during a call

- ▶ Select **#123**.
- ▶ Enter numbers or characters.

Ending a call

- ▶ Press the **[OK]** button.

Operating external data carriers

Useful information

You can switch between the following media sources, depending on the type of external data carrier connected:

- USB 1 or iPod 1
- USB 2 or iPod 2
- AUX (external audio equipment)
- BT Audio (with Bluetooth® connected device, such as a mobile phone)

Selecting external data carriers

- ▶ Press the **[MEDIA]** button repeatedly until the desired media source appears in the display.

Operating a USB device or iPod®

Connecting a device

- ▶ Connect the device to the USB port. The device is activated automatically and the first track is played.

Selecting a track

- ▶ In USB mode, press the **[OK]** button. Available tracks or folders are displayed.
- ▶ Turn control **[6]**.
- ▶ Press **[OK]** to confirm.

Rapid search

- ▶ Press the **[OK]** button. An entry field appears.
- ▶ To enter characters, turn control **[6]** and press the **[OK]** button.

Skipping to the next or previous track

- ▶ Press the **[▶▶]** or **[◀◀]** button briefly to skip to the next track or press longer for rapid scrolling.

Switching random track sequence on/off

- ▶ Press the **[◀◀]** button.

Switching the repeat function on/off

- ▶ Press the number key.

Selecting a track from a category with an iPod® connected

- ▶ Press the **[OK]** button.
- ▶ Select the category from a list. Different categories, such as playlists, artists or albums, can be selected, depending on the connected device.

Displaying metadata

- ▶ Press the **[TEXT]** button repeatedly until the desired metadata is displayed.

Operating external audio equipment (AUX)

Connecting a device

- ▶ Connect the device to the AUX jack.
Use the **MEDIA** button to access the media on a connected AUX device.

Adjusting the volume of external audio equipment

- ▶ Press the **SETUP** button.
- ▶ Select **Audio**.
- ▶ Select **AUX In**.
- ▶ Select one of the following options for the volume:
 - **Low**
 - **Medium**
 - **High**

Bluetooth® device operation

Connecting a device

- ▶ Connect a Bluetooth® audio device the same way you connect a mobile phone with Bluetooth®.

Skipping to the next or previous track

- ▶ Press the **▶▶** or **◀◀** button briefly to skip to the next track or press longer for rapid scrolling.

Displaying metadata

- ▶ Press the **TEXT** button repeatedly until the desired metadata is displayed.

Operating and setting up the smart Media-System





Operating the smart Media-System

Please note

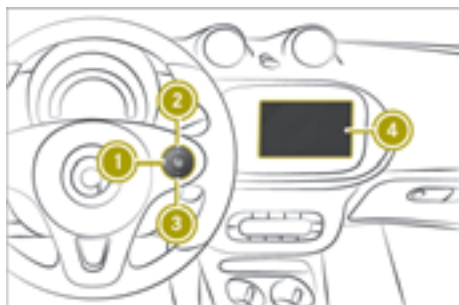
Some functions are restricted while driving.

Controls



- ①  Switches voice control system on and off, accepts and ends a phone call
- ②  Increases the volume
- ③  Reduces the volume
- ④  smart Media-System display

Voice Control System

The following functions are possible using the voice control system of the smart Media-System:

- Enter a destination for navigation.
- Make a call.
- Start an application.

Controls on the smart Media-System

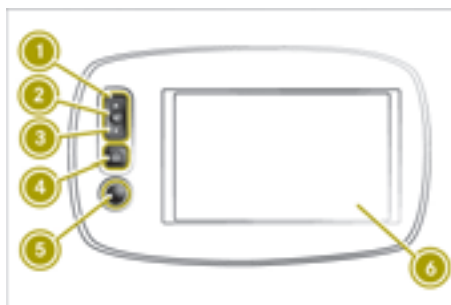

- ① Previous station or track and fast rewind
- ② Mute
- ③ Next station or track and fast forward
- ④ To switch to the home screen
- ⑤ On/off button  and volume control
- ⑥ Touchscreen

Ports on the center console

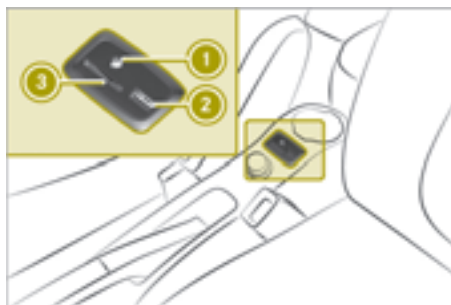

- ① Port for external audio equipment (AUX)
- ② USB port
- ③ SD card slot

Overview of home screen



- ① Radio station, media track
 - ② Status of the mobile phone and field strength of the mobile phone network
 - ③ Outside temperature
 - ④ Time
 - ⑤ Traffic reports for the planned route
 - ⑥ Map
 - ⑦ Next navigation maneuver
 - ⑧ Context menu
 - ⑨ Favorites menu
 - ⑩ Main menu
- i** The home screen can be set to display the energy flow.

Switching the smart Media-System on/off

Switching on automatically

- ▶ Start the engine.

Switching off automatically

- ▶ Switch off the ignition and open the door.

Switching on and off manually

- ▶ Press the  button.

Scrolling through a menu or list on the touchscreen

- ▶ Touch the touchscreen with your finger.
- ▶ Swipe up, down, left or right. The selection on the display will then move in the respective direction.

Selecting items on the touchscreen

- ▶ Tap on a menu, an option or an application with one finger. The menu, the option or the application is launched.

Controlling media playback on the touchscreen

- ▶ Swipe to the left. The next media item is played or displayed, e.g. the next track or station.
- ▶ Swipe to the right. Playback is restarted or the previous media item is played or displayed, e.g. the previous track.

Media playback can be controlled in the following playback modes:

- Radio mode
- Music and audio playback
- Image playback
- Video playback

Calling up menus

- ▶ Select **Menu** on the home screen. Select one of the following submenus:
 - **Multimedia**
Radio and media playback
 - **Navigation**
Navigation system
 - **Telephone**
Mobile phone functions
 - **Vehicle**
eco score, energy flow and consumption details
 - **Services**
Apps and TomTom services
 - **System**
General systems settings

Confirming settings

- ▶ Select **Done**. Settings are accepted.

Switching off the display

- ▶ Select home page >  > **Switch off screen**.

Adjusting the system settings

Adjusting the display

Setting the daytime brightness

- ▶ Select **System** > **Display**.
- ▶ Move the **Daytime brightness** control to the left or right.

Setting the nighttime brightness

- ▶ Select **System** > **Display**.
- ▶ Move the **Nighttime brightness** control to the left or right.

Activating automatic switching between daytime and nighttime brightness

- ▶ Select **System** > **Display** > **Switch to night mode when dark**.

Displaying night mode constantly

- ▶ Select **Use night mode**.

Setting the system language

- ▶ Select **System** > **Language**.
A list of available languages is displayed.
- ▶ Select the desired language.

i The language of the spoken navigation commands can be selected independently of the system language.

Changing the on-screen keyboard

- ▶ Select **System** > **Keyboards**.
- ▶ Select one of the following keyboard layouts:
 - **Latin**
 - **Greek**
 - **Cyrillic**

For the **Latin** keyboard layout, it is possible to choose between the **ABCD**, **QWERTY**, **AZERTY** and **QWERTZ** layouts.

Selecting the home screen display

- ▶ Select **System** > **Home page**.
A selection of home screen displays appears.
- ▶ Select the desired display.

Restoring the factory settings

- ▶ Select **System** > **Factory settings**.
- ▶ Confirm with **Yes**.
All settings changed in the system will return to the default values. All destinations, routes and favorites will be deleted.

Setting the time manually

- ▶ Select **System** > **Clock** > **Set time**.
- ▶ Change the minutes and hours of the time shown.

Activating automatic time adjustment

- ▶ Select **System** > **Clock** > **Set time** > **Automatic time adjustment**.

Setting the time format

- ▶ Select **System** > **Clock** > **Time format**.
- ▶ Choose one of the following time formats:
 - **18:00**
 - **6:00 PM**
 - **6:00**

Displaying status and information

- ▶ Select **System** > **Status & Information**.
- ▶ Select one of the following information options:
 - **Version information**
Software and hardware of the Media-System
 - **GPS status**
Current GPS signal strength
 - **Network status**
Signal strength of the data connection
 - **Licenses**
For free and open-source software used
 - **Copyright**
For texts in the TomTom software used

Adjusting the audio settings

Setting the volume

- ▶ Select **System** > **Sound** > **Volumes**.
- ▶ Select one of the following volume settings:
 - **Main volume**
For the whole system
 - **Hands-free**
For the hands-free system
 - **Ringtone**
The volume of the ringtone
 - **Navigation**
Volume for the whole navigation system
 - **Computer voice**
Volume of the computer-generated voice
 - **App events**
Volume of events triggered by apps
- ▶ Set the desired volume.

Adjusting the volume to the vehicle speed (vehicles without JBL sound system)

The speed-dependent volume adjustment function adapts the volume to the current vehicle speed.

- ▶ Select **System** > **Sound** > **Speed dependency**.
- ▶ Move the **Speed dependency** control to the left or right.
The higher the value, the more the volume increases with the speed of the vehicle.

Volume adjustment is not set using the control but automatically.

Adjusting surround sound (balance)

- ▶ Select **Multimedia** > **Settings** > **Sound** > **Balance** > **Manual**.
- ▶ Move the control to the desired position.
- ▶ Confirm with **Done**.

Adjusting the bass and treble

- ▶ Select **Multimedia** > **Settings** > **Sound** > **Bass/Treble** > **Manual**.
- ▶ Use the control to adjust the bass and treble separately.

Setting a neutral sound for the bass and treble

- ▶ Select **Multimedia** > **Settings** > **Sound** > **Bass/Treble** > **Neutral**.
Audio is played without increasing the bass or treble.

Activating and deactivating arkamys® bass boost (vehicles without JBL sound system)

The arkamys® bass boost setting emphasizes the bass during playback.

- ▶ Select **Multimedia** > **Settings** > **arkamys bass boost**.

Manual activation of arkamys® bass boost on models with a JBL sound system is not possible. Activation functions automatically.

Setting the volume for warning tones

- ▶ Select **System** > **Sound** > **Warnings**.
- ▶ Move the control to the left or right.

Enabling warning tones when the display is switched off

- ▶ Select **System** > **Sound** > **Warnings** > **Sound warning tones when display turned off**.

Creating and deleting favorites

Creating favorites



- ① Preset
- ② Navigation
- ③ Radio

- ④ Telephone
- ⑤ Services
- ⑥ Context menu

Frequently used settings such as phone contacts and radio stations can be stored as favorites. Six favorites can be stored for each of the following categories:

- Navigation
- Radio
- Telephone
- Services
- ▶ Select **Favorites** on the home screen.
- ▶ Select category.
- ▶ Select the next empty memory position. A list of possible favorites appears.
- ▶ Select Favorites.

Deleting favorites

- ▶ Select **Favorites** on the home screen.
- ▶ Press **+**.
- ▶ Select **Remove a Favorite**.
- ▶ Perform one of the following steps:
 - Select the favorite to be removed and press **Delete** to confirm.
 - To delete all favorites, select **Remove all Favorites**.

Listening to the radio

Switching on the radio

- ▶ Select **Multimedia > Radio**.

Display modes

Useful information

In radio mode there are three different display modes, in which various settings can be made:

- “List” display mode
- Frequency display mode
- “Presets” display mode

“List” display mode



- ① Selects radio mode and memory level
- ② Selects previous station
- ③ Selects next station
- ④ Context menu
- ⑤ Selects “frequency” display mode
- ⑥ “List” display mode
- ⑦ Selects “presets” display mode
- ⑧ Station currently playing

Frequency display mode



- ① Selects the waveband and preset group (FM)
- ② Increases or decreases the frequency in small increments
- ③ Station search, forward or back
- ④ Context menu
- ⑤ Adjusts the frequency manually
- ⑥ Station currently playing

“Presets” display mode



- ① Selects the waveband and preset group (FM/DAB)
- ② Stored station
- ③ Context menu
- ④ Station currently playing

Selecting a station

“List” display mode

- ▶ Swipe up or down in the station list
- ▶ Tap on the desired station.

Frequency display mode

- ▶ Slide control on the waveband left or right

Starting a station search

- ▶ Select or in the “frequency” display mode

Storing a station

- ▶ Set the station.
- ▶ Select > **Save as preset**.

Up to six stations can be stored for each waveband.

Displaying radio text

Radio text contains information such as current track or latest news.

- ▶ Select > **Show radio text**.

Other radio settings

Receiving traffic reports (i-Traffic)

- ▶ Select **Multimedia** > **Settings** > **Radio** > **i-Traffic** (Traffic program).

Displaying the program type (e.g. classical music)

- ▶ Select **Multimedia** > **Settings** > **Radio** > **PTY** (Program type).

Updating the station list

- ▶ Select **Multimedia** > **Settings** > **Radio** > **Update radio list**.

Calling up electric drive displays

Calling up the energy flow display message

- ▶ Select **Menu** > **Vehicle** > **electric drive** > **Energy flow**.

The **Energy flow** display shows the flow of energy in the vehicle.

The energy flow is displayed in color, this indicates the following:

- Green coloring: energy is being recuperated
- Orange coloring: drive is consuming energy
- Yellow color and example illustration of the consumer: auxiliary consumers are using energy
- Gray color: no energy is being recuperated or consumed

Calling up consumption details

- ▶ Select **Menu** > **Vehicle** > **electric drive** > **Consumption details**.

The **Consumption details** display shows the energy consumption of the drive and electrical consumers as well as the energy recuperated during the previous 15 minutes. The display also shows the overall consumption of the drive and auxiliary consumers as well

as the total recuperated energy of the current trip.

The **Consumption details** display is reset each time the engine is switched on.

Using a mobile phone

Connecting a mobile phone

Please note

WARNING

The electromagnetic radiation from modified or incorrectly retrofitted RF-transmitters can interfere with the vehicle electronics. This can compromise the operational safety of the vehicle. There is a risk of an accident.

You should have all work to electrical and electronic equipment carried out at a qualified specialist workshop.

WARNING

The electromagnetic radiation from incorrectly operated RF transmitters can interfere with the vehicle electronics, for example:

- if the RF transmitter is not connected with an exterior antenna
- the exterior antenna has been installed incorrectly or is not a low-reflection type

This can compromise the operational safety of the vehicle. There is a risk of an accident.

Have the low-reflection exterior antenna mounted at a qualified specialist workshop. When operating RF transmitters in the vehicle, always connect them with the low-reflection exterior antenna.

Bluetooth® must be enabled both on the mobile phone and on the smart Media-System.

Enabling and disabling Bluetooth®

The mobile phone must be compatible with the smart Media-System.

For an overview of compatible mobile phones, visit: <https://www.smart.com/connect>.

- ▶ Select **Settings > Turn Bluetooth on**.

The setting is marked. Bluetooth® is enabled or disabled on the smart Media-System.

Authorizing a mobile phone

Authorizing a mobile phone for the first time

Bluetooth® must be enabled on the smart Media-System.

- ▶ Select the **Telephone** menu.
- ▶ Confirm the display message with **Yes**.
- ▶ Enter the security code on the mobile phone or accept access confirmation (see the manufacturer's Operator's Manual). The message **Bluetooth is enabled** is shown.

Authorizing another mobile phone

Bluetooth® must be enabled on the smart Media-System.

- ▶ Select **Settings > Manage phones**. The list of visible mobile phones is displayed.
- ▶ Select a mobile phone from the list.
- ▶ Enter the security code on the mobile phone or accept access confirmation (see the manufacturer's Operator's Manual). The Bluetooth® connection is established. The Bluetooth® connection will be established automatically in future.

Downloading telephone data automatically

- ▶ Select **Settings > Automatically download phone data**.
- ▶ If necessary, accept the access confirmation on the mobile phone. During connection, up to 1000 contacts are automatically transferred to the smart Media-System.

Connecting another authorized mobile phone

- ▶ Select **Settings > Manage phones**.
- ▶ Select a mobile phone.
The current Bluetooth® connection is terminated. The desired mobile phone is connected to the smart Media-System instead.

Removing a mobile phone from the list

- ▶ Select **Settings > Manage phones**.
- ▶ Select **[+] > Delete device(s)**.
- ▶ Select a mobile phone.
- ▶ Select **Delete**.

Terminating a Bluetooth® connection

- ▶ Select **Settings > Manage phones**.
- ▶ Select **[+] > Disconnect all devices**.
- ▶ Select a mobile phone.

If the mobile phone leaves the Bluetooth® receiver range, the connection is automatically terminated.

Using MirrorLink™

Useful information

MirrorLink® is standard for the connection between the smart Media-System and a mobile phone. With MirrorLink®, the content of the display on your mobile phone can be displayed in the smart Media-System.

MirrorLink™ is available for mobile phones with the "Android" operating system.

Further information: <http://www.smart.com/connect>.

To use MirrorLink™, observe the following requirements:

- the mobile phone must support MirrorLink™ version 1.1 and above
- the mobile phone is switched on
- a MirrorLink™ certified App must be installed on the phone
- the GPS connection must be activated on the mobile phone
- the time is set on the smart Media-System

Setting up a connection

- ▶ Activate MirrorLink™ on your mobile phone (see the manufacturer's operating instructions).
- ▶ Connect a mobile phone with a connecting cable to the USB socket in the center console.
- ▶ Select **Yes**.
Apps which have been certified for MirrorLink™ will be shown in the smart Media-System display.

Calling up MirrorLink™ Apps

- ▶ Select **Services > MirrorLink™**.
- ▶ Select the desired app.
The display switches to full screen mode.
- ▶ **To leave full screen display:** press and hold the **[Home]** button on the smart Media-System until the lower bar is shown.
- ▶ **To exit the display:** select **[Back]**.

MirrorLink™ audio playback

If your mobile phone supports this function, you can control audio playback via the buttons on the smart Media-System.

- ▶ **To select the previous track:** press the **[Previous]** button.
- ▶ **Fast rewind:** press and hold the **[Previous]** button.
- ▶ **To select the next track:** press the **[Next]** button.
- ▶ **Fast forward:** press and hold the **[Next]** button.
- ▶ **To mute:** press the **[Mute]** button.

Disconnecting the MirrorLink™ connection

- ▶ Select **[+] > Disconnect**.

Using the telephone

Useful information

The following conditions must be fulfilled in order to make a 999 or 112 emergency call:

- A valid and operational SIM card is inserted in the mobile phone.
- A mobile phone network is available.

Calling a contact from the phone book

- ▶ Select **Phonebook**.
- ▶ Select the contact.
- ▶ Select the contact's telephone number.

If the phone book contains multiple contacts, they can be called up using a **Search**.

Dialing a number

- ▶ Select **Dial a Number**.
- ▶ Enter a number on the keypad.
- ▶ Select **Call**.

Calling a contact from the call log

- ▶ Select **Call logs**.
- ▶ Select an entry from the list.

The call log can be sorted according to calls made, calls received and missed calls using the corresponding receiver icon.

Accepting and rejecting an incoming call

If a call is incoming, the following information will appear on the display:

- Name of caller, if already in the phone book.
- Number of caller, if name of caller not already in the phone book
- **Private number**, if the caller has Hide caller ID switched on.
- ▶ To accept the call, select **Pick up**.
- ▶ To reject the call, select **Refuse**.
The call will be forwarded to voice mail.

Holding and continuing a call

- ▶ Select **[+]** > **Place on hold**.
- ▶ To continue the call, select **Resume**.

Transferring a call to the mobile phone

- ▶ Select **[+]** > **Handset**.

Ending a call

- ▶ Select **End call**.

Further settings

Setting the volume

- ▶ Select **Settings** > **Sound levels**.
- ▶ Set the volume of the hands-free system and the ringtone.

Activating voice mail

- ▶ Select **Voice mail**.
- ▶ Enter the voice mail number on the keypad.
- ▶ Select **Done**.
Voicemail is activated and the voicemail number is dialed.

Configuring voicemail

- ▶ Select **Settings** > **Voicemail configuration**.

Updating the phone book

A Bluetooth® connection must be present.

- ▶ Select **Phonebook** > **[+]** > **Update phone data**.

Updating the call log

- ▶ Select **Call logs** > **[+]** > **Update phone data**.

Adding a contact to favorites

- ▶ Select **Telephone** > **Phonebook**.
- ▶ Select a contact from the list.
- ▶ Select **[+]** > **Add to favorites**.
- ▶ Dial a phone number.

Connecting and operating external data carriers

Useful information

The following external data carriers can be connected:

- USB memory stick (USB 2.0 or 3.0 with max. 64 GB) or iPod™
- SD or SDHC card (max. 64 GB)
- External audio equipment (AUX jack)
- Bluetooth® devices such as mobile phones

The following formats are supported:

- MP3 files
- WMA files
- ACC formats
(.AAC, .M4A, .M4B, .M4P, .M4V, .M4R, .MP4 and .3GP)
- OGG Vorbis (.OGG, .OGA)
- PCM 16 bit (.WAV, .PCM)

A data carrier may contain no more than eight directory levels.

The smart Media-System only recognizes the first partition of a data carrier. The partition must be formatted as FAT or FAT32.

Connecting external data carriers

Connecting a USB memory stick

- ▶ Insert a USB memory stick in the port on the center console.
Playback starts automatically.

Connecting an SD card

- ▶ Insert an SD card into the SD card slot in the center console.
Playback starts automatically.

Connecting a Bluetooth® device

- ▶ Authorize and connect a Bluetooth® device, such as a Bluetooth®-capable mobile phone.

Operating external data carriers

Selecting connected external data carriers

- ▶ Select **Menu > Multimedia > Media**.
- ▶ Select connected medium.

Controlling playback from a USB memory stick or SD card



- ① Selects the previous track
- ② Selects the next track
- ③ Stops and continues playback
- ④ Switches track repeat on
- ⑤ Switches random playback on
- ⑥ Calls up the context menu
- ⑦ Displays the playlist
- ⑧ Selects a new track based on categories, e.g. album, genre, folder
- ⑨ Resumes playback at any point in the track

Controlling playback from a Bluetooth® device



- ① Selects a new track
- ② Selects the previous track

- ③ Stops playback
- ④ Selects the next track
- ⑤ Displays the playlist
- ⑥ Calls up the context menu



Selecting a different device

- ▶ Select  > **Change source**.

Connecting another authorized Bluetooth® device

- ▶  > Select **Find new device**.

Enabling and disabling random playback

- ▶ To enable: select  > **Enable random playback**.
- ▶ To disable: select  > **Disable random playback**.

Displaying details of tracks on a USB memory stick or SD card

- ▶ Select  > **Track details**.

Selecting a track from current playlist

- ▶ Select **New selection** > **Folders**.
The current playlist is displayed.
- ▶ Select **Find**.
A keyboard is shown.
- ▶ Enter the name or part of the name of the track you are looking for.

Selecting a track from categories

- ▶ Select **New selection**.
- ▶ Select category for playback.

Switching album cover display on and off

The album cover must be saved in the audio file.

- ▶ Select **Multimedia** > **Settings** > **Media** > **Display album cover**.

Viewing images

Useful information

Images that have been saved to an SD card or USB memory stick can be viewed in the smart Media-System.

The following file formats can be displayed:

- .JPG
- .GIF
- .PNG
- .BMP

Image playback

Starting image playback

- ▶ Insert SD card or USB memory stick into the corresponding port.
- ▶ Select **Multimedia** > **Pictures**.
- ▶ Select media source **USB** or **SD**.
- ▶ Select folder.
- ▶ Select image.

Switching between images

- ▶ Swipe left or right.

Specifying a new selection of images

- ▶ Select **New selection**.

Setting image playback

Switching from normal to thumbnail view

- ▶ Select **Thumbnails**.

Switching from thumbnail to normal view

- ▶ Select an image.

Displaying in full screen mode

- ▶ Select  > **Full screen**.

Activating the controls in full screen mode

- ▶ Tap the touchscreen.

Switching from full screen mode to normal view

- ▶ Select  > **Normal view**.

Enlarging the image

- ▶ Select  > **Zoom in**.

Showing images as a slide show

- ▶ Select  > **Slide show**.

Setting the display duration

- ▶ Select  > **Image settings** > **Slide show delay**.
- ▶ Set the desired time using the controls.

Setting default view for image playback

- ▶ Select  > **Image settings** > **Default view**.
- ▶ Select **Normal view** or **Full screen**.

Video playback

Video playback

Starting video playback

- ▶ Insert SD card or connect USB stick.
- ▶ Select **Multimedia** > **Video**.
- ▶ Select **USB** or **SD**.
- ▶ Select folder or video.
All videos in a folder are played one after the other.

-  The size of the video file may have an impact on the performance of the system. Therefore, only playback videos with a length of up to 5 minutes.

Selecting the next or previous video

- ▶ Select  or .

Stops and continues playback

- ▶ Select .

Playing a new video

- ▶ Select **New selection**.
- ▶ Select a new video

Setting the video view

Playing videos in full screen mode

- ▶ Select **Full screen**.

Setting the default view for video playback

- ▶ Select  > **Video settings**.
- ▶ Select **Normal view** or **Full screen**.

Using the navigation system

Starting the navigation system

Please note

WARNING

If you operate information systems and communication equipment integrated in the vehicle when driving, you may be distracted from the traffic situation. You could also lose control of the vehicle. There is a risk of an accident.

Only operate this equipment when the traffic situation permits. If you are not sure that this is possible, park the vehicle paying attention to traffic conditions and operate the equipment when the vehicle is stationary.

The navigation system does not provide information on stop signs, right of way signs, traffic regulations or road safety regulations.

Traffic regulations always take priority over the navigation system's driving recommendations.

Observe the legal stipulations and traffic regulations of the country you are driving in when in navigation mode.

Starting the navigation system

- ▶ Select **Menu > Navigation**.
The following functions can be carried out:
 - Searching for a destination
 - Planning a route
 - Displaying a map
 - Changing navigation settings

Reading map data

WARNING

SD cards are small parts. They can be swallowed and cause choking. This poses an increased risk of injury or even fatal injury.

Keep the SD card out of the reach of children. If a SD card is swallowed, seek medical attention immediately.

- ! To prevent damage to data, only use the SD card provided for the data in the Media-System or for updating map and systems files.
- ▶ Insert an SD card into the SD card slot in the center console.
- ▶ Switch on the device.
The map data is read by the navigation system.

Removing an SD card

- ▶ Select **Menu > System > Remove SD-card**.
- ▶ Confirm the display message with **Yes**.
- ▶ Press the SD memory card.
- ▶ Remove the SD card from the slot.

Updating map data

Regular updates are supplied for the map data. The first update can be downloaded for free in the web portal within 90 days of vehicle activation. This requires registration at

<http://tomtom.com/forsmart>. Further information is available from any smart Center.

- ▶ Remove SD card from the vehicle and insert into a computer.
- ▶ Install update software on the computer.
- ▶ Run the map update assistant.

i As well as updates, the latest software for the Media-System can be downloaded and Premium Voices by TomTom can be purchased.

Configuring the settings for electric drive

- ▶ Select **Menu > Navigation > Settings > electric drive settings**.
The following functions can be called up:
 - activating or deactivating the battery warning
A display message appears when the battery charge level has reached 20% and the battery warning is activated.
 - hiding or displaying charging stations on the map
 - managing charging stations
 - selecting a charging cable

The specified charging type and charging cable type settings are used for navigation in order to limit the selection of the available charging stations. During navigation, the following options can be selected via the  context menu:

- search for type of charging
- search for electricity provider
- display all charging stations

A display message appears if the specified settings and a selected charging station are incompatible.

Entering and managing destinations

Entering a destination by address

- ▶ When using the navigation system for the first time, enter country.
- ▶ Select **Navigation > Drive to... > Address**.
- ▶ If desired, change the country using the flag symbol.

- ▶ Enter city or ZIP code.
- ▶ Select the destination from the list.
- ▶ Select the street.
- ▶ Select the house number.
- ▶ Confirm with **Done**.

Searching for a parking lot near the destination address

This function can be called up when entering the destination.

- ▶ Select  > **Nearby parking lot**.
A list of parking lots near the current destination appears.

Displaying information about the destination address

This function can be called up when entering the destination.

- ▶ Select  > **Show info**.

Entering a destination using the map

A location on the map can be selected as the destination.

- ▶ Select **Navigation > Drive to... > Point on map**.
- ▶ Align map view with the destination.
- ▶ Tap the destination point on the display.
The symbol selected is highlighted in blue.
- ▶ Tap on the symbol to confirm.

Entering a destination using the voice control system

The voice control system must be switched on.

- ▶ Say the command "Enter address".
- ▶ When prompted by the voice control system, say the destination address, including street name, house number and city.
- ▶ Say the voice command "Yes" or, if several possible destinations are displayed, say the number.

Selecting a destination from the list of last destinations

- ▶ Select **Navigation > Drive to... > Recent destinations**.
- ▶ Select destination.

Entering a destination using geo-coordinates

- ▶ Select **Navigation > Drive to... > Latitude Longitude**.
- ▶ Enter the longitude and latitude

Setting home location

- ▶ Select **Navigation > Settings > Set home address**.
- ▶ Enter a home address

Setting home as a destination

- ▶ Select **Navigation > Drive to... > Home**.

Selecting a saved location as destination

At least one destination must be stored for this function.

- ▶ Select **Navigation > Drive to... > Saved locations**.
- ▶ Select destination.

Managing saved locations

- ▶ Select **Navigation > Settings > Manage saved locations**.

Entering a point of interest

POIs such as museums, restaurants or car parks near a location are displayed on the map.

- ▶ Select **Navigation > Drive to... > Point of interest**.

The following list of surrounding areas appears. A POI can be searched for in these areas:

- **POI near you**
- **POI along route**
- **POI near destination**

- [POI near Home](#)
- [POI in city](#)
- ▶ Select surrounding area for the search for a POI.
The following list of categories for POIs appears:
 - A list of categories for POIs: e.g. a gas station or restaurant
 - A POI name search
 - A POI search within a category
- ▶ Select category for the search.
- ▶ Select POI.

Managing POIs

Adding a POI category

- ▶ Select [Navigation](#) > [Settings](#) > [Manage POIs](#) > [Add POI category](#).
- ▶ Enter the name and symbol for the new POI category.

Deleting a POI category

- ▶ Select [Navigation](#) > [Settings](#) > [Manage POIs](#) > [Delete POI category](#).
- ▶ Select the POI category to be deleted.

Adding POIs

- ▶ Select [Navigation](#) > [Settings](#) > [Manage POIs](#) > [Add POI](#).
If no POI categories have been defined yet, a prompt appears to enter a POI category.
- ▶ Select the category for the POI.
- ▶ Enter your POI.

Deleting POIs

- ▶ Select [Navigation](#) > [Settings](#) > [Manage POIs](#) > [Delete POI](#).
- ▶ Select POI category.
- ▶ Select the POI to be deleted.

Editing POIs

- ▶ Select [Navigation](#) > [Settings](#) > [Manage POIs](#) > [Edit POI](#).
- ▶ Select POI category.
- ▶ Customize the POI properties.

Setting alerts for a nearby POI

- ▶ Select [Navigation](#) > [Settings](#) > [Manage POIs](#) > [Warning when near POI](#).
- ▶ Select POI category.
- ▶ Set the distance at which the message should appear.
- ▶ Set the type of alert issued.

Entering a destination via “TomTom Places”

POIs from the “TomTom Places” database are available using the “TomTom Places” function.

- ▶ Select [Navigation](#) > [Drive to...](#) > [TomTom Places](#).

A list of search criteria appears which can be used to search for a POI.

- ▶ Select the search criteria.
- ▶ Enter a search term.

Changing the route

Useful information

Once the destination has been selected, the navigation system calculates the route to the destination. The following options are available for adjusting the route guidance:

- Calculate alternative routes.
- Adjust routes calculated by the navigation system.
- Plan routes in advance and travel via specific way points.
- Adjust settings for calculating routes.

Once the route is calculated, a route summary is shown. By default, the quickest route will be calculated for route planning, taking into account IQ Routes™. Traffic information is taken into account when calculating the route.

The “route overview” function allows you to set whether the summary of a calculated route is automatically faded out from the display after 10 seconds.



If the route is not confirmed with **Done**, route guidance will start automatically after approximately ten seconds.

Displaying a planned route

Calculating the route

- ▶ Enter a destination.
- ▶ Select **Done**.

Displaying the route details

- ▶ Select  > **Route details**.
- ▶ Select one of the following functions:
 - **Display instructions**
An overview of the route with directions appears.
 - **Display a map of the route**
The route appears on a map.
 - **Start demonstration**
A simulation of the route guidance for the planned route is started. To end the simulation, tap on the touchscreen and confirm you want to cancel by tapping on **Yes**.
 - **Display the destination**
The destination for the route appears.
By pressing , it is possible to search for a car park near the destination or add the location to the saved locations.
 - **Show traffic on route**
Traffic disruptions along the route are shown.
 - **Summary**
A summary of the route details appears.

Saving a planned route

- ▶ Select  > **Save Itinerary**.

Changing the route

Canceling the route

- ▶ Select **Navigation** > **Change route** > **Cancel route**.
Route guidance can be resumed again when a new destination is entered.

Calculating an alternative route

- ▶ Select **Navigation** > **Change route** > **Calculate alternative**.
A new route is calculated and displayed that takes you on different roads.
- ▶ Select the alternative route or a previous one.

Route guidance via way point

The route can be adjusted by entering up to four way points.

- ▶ Select **Navigation** > **Change route** > **Travel via**.
If a way point has already been entered, a list of the saved way points will be displayed.
- ▶ Select **Add**.
- ▶ Select a new way point from **Address**, **Recent destinations**, **Saved locations**, **TomTom Places** or **POI**.
The new way point is added.

Avoiding road blocks

The route can be changed if a section of road along the route is blocked or there is a traffic jam.

- ▶ Select **Navigation** > **Change route** > **Avoid roadblock**.
- ▶ Select the length of the route that needs to be avoided.

Avoiding specific roads

The route is calculated to avoid specific roads.

- ▶ Select **Navigation** > **Change route** > **Avoid part of route**.
A list of the roads on the route is displayed.
- ▶ Select the road you wish to avoid.

Taking traffic disruptions into account

The route is recalculated based on current traffic information

Traffic information is only available with HD Traffic.

- ▶ Select **Navigation** > **Change route** > **Minimize delays**.
An overview of the traffic disruptions along the route will be shown.
- ▶ Select the traffic disruption you wish to avoid.

Planning a route in advance

Adding a route

- ▶ Select **Navigation** > **Routes**.
- ▶ Select **Add**.
- ▶ Select the starting point of the route.
- ▶ Enter the route destination.
- ▶ Enter at least one way point for the route.
- ▶ Enter the route name.
- ▶ Confirm with **Done**.

Starting navigation using a saved route

- ▶ Select **Navigation** > **Routes**.
- ▶ Select the desired route.
- ▶ Select  > **Go**.

Setting route planning

Selecting the route type

- ▶ Select **Navigation** > **Settings** > **Route planning** > **Route types**.
- ▶ Select one of the following settings:
 - **Ask for every route**
 - **Always plan the fastest route**
 - **Always plan eco routes**
 - **Always avoid highways**
 - **Always plan the shortest route**

Selecting the setting for toll roads

- ▶ Select **Navigation** > **Settings** > **Route planning** > **Toll roads**.
- ▶ Select one of the following settings:
 - **Ask for toll roads on route**
 - **Always avoid toll roads**
 - **Do not avoid toll roads**

Selecting the setting for ferry connections

- ▶ Select **Navigation** > **Settings** > **Route planning** > **Ferry connections**.
- ▶ Select one of the following settings:
 - **Ask for ferries on my route**
 - **Always avoid ferries**
 - **Do not avoid ferries**

Selecting the setting for unpaved roads

- ▶ Select **Navigation** > **Settings** > **Route planning** > **Unpaved roads**.
- ▶ Select one of the following settings:
 - **Ask for unpaved roads on my route**
 - **Always avoid unpaved roads**

Selecting the setting for carpool lanes

Carpool lanes are lanes which can only be used by vehicles with at least two occupants.

- ▶ Select **Navigation** > **Settings** > **Route planning** > **Carpool lane settings**.
- ▶ Select one of the following settings:
 - **Ask for carpool lanes on my route**
 - **Always avoid carpool lanes**.
 - **Never avoid carpool lanes**

Using information during route guidance

Useful information

Navigation messages provide guidance during the journey without distracting you from traffic conditions. The display also shows information about the route.

Switching navigation messages on and off

- ▶ Select **Navigation** > **Settings** > **Turn on voice guidance** or **Turn off voice guidance**.

Information such as traffic reports and warnings will be played even if the navigation messages have been switched off.

During route guidance, traffic information (TMC) can be shown for the route ahead.

Live services are not available in all countries and regions. Further information: <http://tomtom.com/services>

Tracking navigation on the display



- ① Increases or reduces the map view
- ② Traffic information
- ③ Route information
- ④ Warning for remaining range to destination
- ⑤ Compass and symbol for two or three-dimensional map display
- ⑥ Next navigation maneuver and symbol for volume adjustment
- ⑦ Information about current radio or media playback or information about active telephone calls

► Tap on the desired symbol in the map view.

The navigation system zooms in on the map view as the vehicle approaches an intersection. This makes it possible to follow turning maneuvers more accurately.

Shortly before navigating a freeway intersection or exit, the display shows a three-dimensional representation of the lanes and the exit. Lane Keeping Assist is not available for all intersections in all countries.

Traffic information details

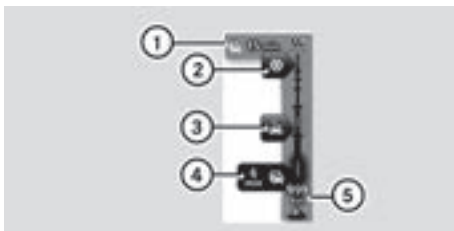

- ① Overall delay on route
- ② Traffic disruption (packed snow)
- ③ Traffic disruption (rain)

- ④ Traffic disruption (traffic jam)
- ⑤ Current position and distance to next traffic disruption

During route guidance, traffic information is shown for the route ahead. When there are a number of traffic disruptions in quick succession, only the very next disruption on the route will be displayed.

Traffic information is only available with HD Traffic.

Color	Meaning
Gray	Unknown or unexplained situation
Orange	Slow-moving traffic
Red	Traffic jam
Dark red	Standstill or road blocked

Calling up more detailed information about the traffic problems

- Tap on the display for traffic information during route guidance.

Scrolling through the traffic reports

- Tap on the message on the touchscreen and swipe left or right.

Displaying the map for a location

Useful information

With the "View map" function, the display shows a two-dimensional map. The map shows your current position, as well as a number of other elements, such as Favorites.

Displaying a map

- Select **Navigation** > **View map**.
A map of the surrounding area will be shown.
- To search: select **[+]** > **Search**.

Controlling the map view

Moving the map

- ▶ Tap on the center of the touchscreen.
- ▶ Swipe in the desired direction. The map will then move in the respective direction.

Zooming in on the map

- ▶ Place two fingers slightly apart in the center of the touchscreen.
- ▶ Move your fingers away from each other.

Reducing the scale of the map

- ▶ Place two fingers, at a greater distance apart, on the screen.
- ▶ Glide your fingers towards each other.

Showing and hiding additional information on the map

- ▶ Select **Navigation > View map.**
- ▶ Select  > **Change map information.**
- ▶ Select one of the following information options:
 - Traffic information
 - Names
 - Points of interest (POIs)
 - Satellite images
 - Coordinates

Using TomTom Services with the navigation system

Useful information

The **TomTom Services** menu can be used to call up and manage traffic information and other TomTom Live Services.

TomTom Live Services are available for a subscription fee. The following TomTom Services come pre-installed and, following activation, can be used free of charge for a period of three years:

- HD Traffic
- Radar cameras (not available in all countries)
- Weather
- TomTom Places

More information on services
<http://www.tomtom.com/services>.

More information on availability in specific countries: <http://smart.com/connect>

TomTom Services can also be called up and managed in the **Services** menu. In the main menu, select **Services > TomTom Services**.

- ❗ If you have subscribed to the TomTom Traffic service, the "traffic information" menu will be called "TomTom Traffic".

Activating TomTom Services

TomTom Services must be activated before using them for the first time. If TomTom Services are not yet activated, a corresponding button will be displayed in the main menu and in the **Services** menu.

- ▶ Select **Services > TomTom Services**.
The TomTom Services installed on the device are displayed.
- ▶ Select the desired TomTom Service.
Update installed is shown. TomTom Services are activated.

Starting TomTom Services

- ▶ Select **Navigation > TomTom Services**.

Checking subscription status for TomTom Services

- ▶ Select **Navigation > TomTom Services > My Services**.
The services available on the device and their subscription status will be shown.

Displaying the traffic information along the route

- ▶ Select **Navigation > TomTom Services > Traffic > Show traffic announcements on route**.
- ▶ To switch between traffic information items, tap on the message on the touchscreen and swipe left or right.

Adjusting the route according to traffic disruptions

- ▶ Select **Navigation > TomTom Services > Traffic > Minimize delays.**

Viewing traffic disruptions on the map

- ▶ Select **Navigation > TomTom Services > Traffic > View map.**
Traffic disruptions are displayed on the map as symbols.
- ▶ To view detailed information, tap on a traffic disruption symbol.

The following symbols are used:

Symbol	Meaning
	Traffic jam
	Road blocked
	Traffic disruption
	Construction site
	One or several lanes blocked
	Accident
	Traffic disruption avoided using the traffic information
	Fog
	Wind
	Snow
	Black ice
	Rain

Viewing traffic information for the route to work

- ▶ Select **Navigation > TomTom Services > Traffic > Traffic info. for route to work.**
- ▶ Select one of the following settings:

- Home to work
- Work to home
- Change the home to work route

Changing the settings for traffic information

- ▶ Select **Navigation > TomTom Services > Traffic > Traffic info. settings.**
- ▶ Select one of the following settings:
 - **Always change to this route**
The navigation system automatically changes the route if a faster route has been calculated due to a traffic report along the route.
 - **Request confirmation for route**
If a faster route has been calculated due to a traffic report, the navigation system will ask which route should be used.
 - **Never change my route**
The navigation system will not change the route, even if a traffic announcement has been made.

Read aloud traffic information

- ▶ Select **Navigation > TomTom Services > Traffic > Read traffic info. aloud.**

Setting the navigation system

Setting the voice

The voice which is used for navigation commands can be changed. It is possible to choose between computer-generated voices or voices recorded by professionals. For voices that have been recorded by professionals, only basic navigation commands will be spoken.

- ▶ Select **System > Sound > Voice.**
- ▶ Select voice for playback.
- ▶ To listen to the voice, select **Test.**

Setting the voice output

- ▶ Select **System > Sound > Voice output settings.**
- ▶ Select one of the following settings:

- Read early warning instructions (for example, ahead, turn left)
- Read aloud lane change instructions
- Read aloud traffic info when navigating
- Read aloud foreign street names
- Read aloud street numbers
- Read aloud street names
- Read aloud weather information
- Read aloud POI warnings
- Read aloud warnings
- Read aloud signposts

Changing the map

- ▶ Select **Navigation** > **Settings** > **Change map**.
- ▶ Select the desired map.

Changing the map color

- ▶ Select **Navigation** > **Settings** > **Change map colors**.
- ▶ Press  or  to select the desired display.

Setting safety warnings

- ▶ Select **System** > **Safety warnings**.
- ▶ To select the desired settings:
 - **Suggest driving breaks**
 - **Warn when driving near schools**
 - **Warn when driving faster than allowed**
 - **Warn when driving faster than a set speed**
- ▶ Select **Resume**.
- ▶ Select a warning tone for the respective safety warning.

For the “Warn when driving faster than a set speed” function, the speed above which the warning tone should sound must be entered.

Setting the units of measurement for distance

All units of measurement for distance in the navigation system can be changed. The units

of measurement for distance in the on-board computer are not changed.

- ▶ Select **System** > **Set units** > **Distance units**.
- ▶ Select one of the following settings:
 - **Kilometers**
 - **Miles**

Setting the units for GPS coordinates

- ▶ Select **System** > **Set units** > **GPS co-ordinate display**.
- ▶ Select one of the following settings:
 - **Degrees (d°)**
 - **Degrees, Minutes (d° m.m')**
 - **Degrees, Minutes, Seconds (d° m' s \')**

Managing apps

Useful information

If available, apps may be installed and managed on the smart Media-System. Apps and the use of TomTom services can be called up and managed in the **Services** menu.

The smart Media-System uses a mobile phone connection for data connection. Please take note of the following information when using data services:

- The mobile connectivity and built-in SIM card for this vehicle can only be used for certain data services. These are offered by certain third parties, as well as Daimler AG. Usage occurs via the smart Media-System in the vehicle. The use of data services requires the conclusion of separate agreements between the vehicle user and the respective provider. Voice service usage is not permitted. As such, the SIM card must be permanently installed as factory equipment.
- The mobile communications connectivity and the SIM card may only be used responsibly in accordance with the applicable laws and other legal requirements of the corresponding countries. Insofar as this is within the power of the vehicle user.
- Upgrading, reproduction, reverse assembly and disassembly of the SIM card are

not permitted. Statutory authority remains unaffected.

Failure to follow the above instructions can in some cases lead to temporary or permanent deactivation of the mobile connection and the SIM card. This depends on the severity of the non-compliance. The measures described here, in particular, protect Daimler AG and its contractual partners from negative legal consequences arising from non-compliance. The availability of mobile connectivity in individual countries depends on the existence of corresponding mobile service agreements with local mobile network providers. Availability can therefore change from time to time. The maximum period of validity for the mobile connectivity is 15 years from the time of installation in the vehicle.

Installing apps

If available, apps may be used on the Smart Media-System. This will require registration at <http://tomtom.com/forsmart>.

- ▶ Remove SD card from the vehicle and insert into a computer.

Further information: <http://tomtom.com/forsmart>.

Displaying and calling up apps

Displaying apps

- ▶ Select **Services** > **Settings** > **Applications manager**.
The apps installed on the SD card are shown in the smart Media-System.

Calling up apps

- ▶ Select **Services**.
- ▶ Select the desired app.

Calling up the connectivity manager

The connectivity manager allows you to manage the devices connected to the smart Media-System.

- ▶ Select **Services** > **Settings** > **Connectivity manager**.

Managing data sharing

Enabling or disabling data sharing

If data sharing has not been enabled beforehand, a corresponding message is shown when the smart Media-System is started up. Data sharing can be enabled or disabled at any time.

- ▶ Select **Services** > **Settings** > **Data sharing**.
- ▶ Select one of the following settings:
 - **Yes**
Enable data sharing
 - **No**
Disable data sharing.

Displaying additional information

- ▶ Select **Services** > **Settings** > **Data sharing** > **About**.

Displaying text in another language

- ▶ Select **Services** > **Settings** > **Data sharing** > **Language**.

Stowing small objects

Please note

WARNING

If you stow objects in the vehicle interior in an unsuitable way, they could slip or be thrown around and thus hit vehicle occupants. Additionally, the cup holders, open stowage spaces and mobile phone brackets cannot restrain the objects placed in them in the event of an accident. There is a risk of injury, especially in the event of braking or sudden changes in direction.

- Always stow objects so they cannot be thrown around in these or similar situations.
- Always ensure that objects do not protrude from the stowage compartments or stowage nets.
- All closable stowage compartments should be closed before beginning your journey.
- Always stow and secure heavy, hard, pointed, sharp-edged, fragile objects or objects which are too large behind the last bench seat or under the passenger seats.

WARNING

The cup holder cannot hold a container secure whilst traveling. If you use a cup holder whilst traveling, the container may be flung around and liquid may be spilled. The vehicle occupants may come into contact with the liquid and if it is hot, they may be scalded. You may be distracted from the traffic conditions and you could lose control of the vehicle. There is a risk of an accident and injury.

Only use the cup holder when the vehicle is stationary. Only use the cup holder for containers of the right size. Always close the container, particularly if the liquid is hot.

- ❗ Only use the cup holders for containers of the right size and which have lids. The drinks could otherwise spill.

Using the compartments

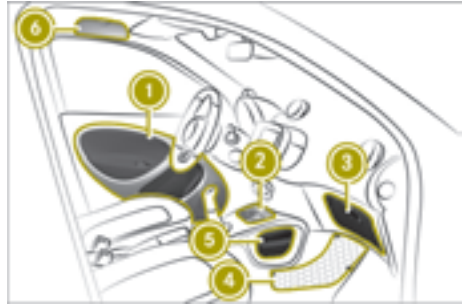

- To stow objects, use the following compartments:
 - ① Stowage compartments in the doors
 - ② Cup holder in the front center console
 - ③ Glove box
 - ④ Stowage net in the front-passenger footwell
 - ⑤ Sliding drawer in the center console
 - ⑥ **smart fortwo coupe electric drive:** eyeglasses compartment above the driver's seat and above the front-passenger seat
 - Cup holder in the rear center console with a recess for storing a mobile phone
 - **smart fortwo Coupe:** stowage compartment in the lower tailgate

Locking/unlocking the glove box

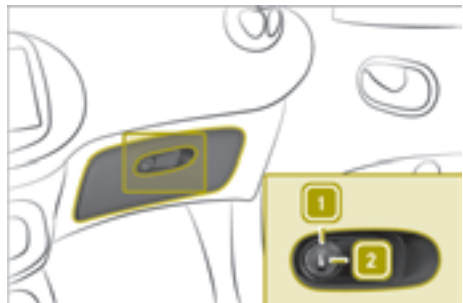

- ▶ Insert the SmartKey into the lock and turn clockwise to position **2** (to lock) or counter-clockwise to position **1** (to unlock).

Opening the stowage compartment in the tailgate (smart fortwo coupe)

- ⚠ Do not exceed the lower tailgate maximum load of 220 lbs (100 kg). It may otherwise become damaged.

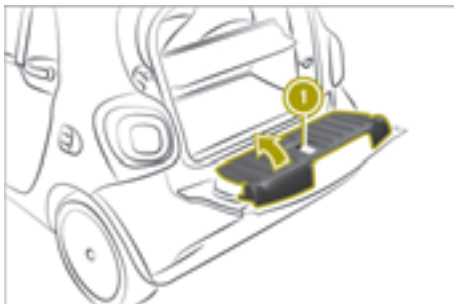

- ▶ Open the tailgate.
- ▶ Pull handle **1** on the inside of the lower tailgate upwards.
- ▶ Lift up the cover in the direction of the arrow.

Stowing luggage and large objects

Please note

⚠ WARNING

If you stow objects in the vehicle interior in an unsuitable way, they could slip or be thrown around and thus hit vehicle occupants. Additionally, the cup holders, open stowage spaces and mobile phone brackets cannot restrain the objects placed in them in the event of an accident. There is a risk of injury, especially in the event of braking or sudden changes in direction.

- Always stow objects so they cannot be thrown around in these or similar situations.
- Always ensure that objects do not protrude over the top of stowage compartments or ruffled pockets.
- All closable stowage compartments should be closed before beginning your journey.
- Always stow and secure heavy, hard, pointed, sharp-edged, fragile objects or objects which are too large behind the last bench seat or under the passenger seats.

The handling characteristics of a laden vehicle are dependent on the distribution of the load within the vehicle.

Observe the following loading guidelines when loading and transporting luggage and loads:

- never exceed the maximum permissible gross mass or the gross axle weight rating for the vehicle (including occupants) The values are specified on the vehicle identification plate on the B-pillar of the driver's door
- the load must not protrude above the upper edge of the head restraints
- ensure that no items of luggage can enter the passenger compartment above or between the seats
- ensure that loaded objects are stowed safely and are secured
- load heavy objects at the bottom and light objects at the top
- the cargo compartment is the preferred place to stow objects
- stow heavy loads as far forward and as low down in the cargo compartment as possible

Opening the trunk (smart fortwo coupe)

- ⚠ The tailgate swings backwards, upwards and downwards when opened. Therefore, make sure that there is sufficient space above, behind and under the tailgate.

- ▶ Press the  button on the SmartKey.
- ▶ Fold the upper tailgate up.

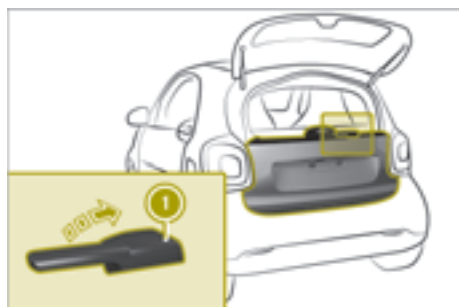

- ▶ Pull lever ① up.
- ▶ Fold the lower tailgate down.

Closing the trunk (smart fortwo coupe)

- ▶ Fold the lower tailgate up and engage on both sides.
- ▶ Pull the upper tailgate down and press it closed.
- ▶ Press the  button on the SmartKey. The vehicle is locked.

Opening the trunk (smart fortwo cabrio)

Opening the tailgate

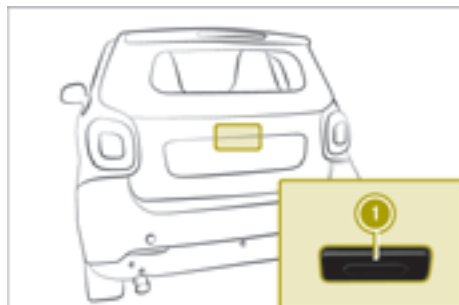

- ▶ Press the  button on the SmartKey.
- ▶ Press button ① in the handle recess.
- ▶ Fold down the tailgate.

Opening the rear soft top

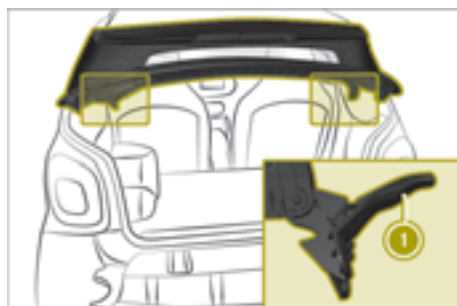

- ▶ Open the tailgate.
- ▶ Press both latch levers ①.
- ▶ Swing the rear soft top up.

Closing the trunk (smart fortwo cabrio)

Closing the rear soft top

- ▶ **!** If you close the tailgate, you must first lock the rear soft top. Otherwise, the latch levers may break.
- ▶ Pull the rear soft top down until it engages.
- ▶ Lock the rear soft top with both latch levers.

Closing the tailgate

- ▶ Pull the tailgate up until it engages.
- ▶ Press the  button on the SmartKey. The vehicle is locked.

Enlarging the cargo compartment: folding the front-passenger seat back- rest forward

Folding down the front-passenger seat backrest (using the lever)

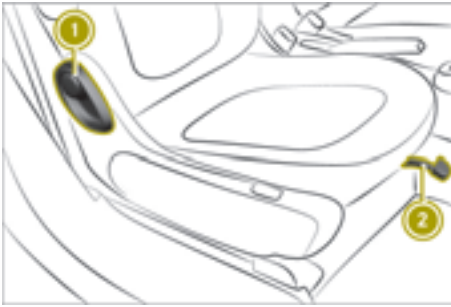

Seat with a lever

- ▶ Lift lever ② and slide the front passenger seat to its rearmost position.
- ▶ Pull lever ① forward.
- ▶ Fold the seat backrest forward at the same time.

Folding down the front-passenger seat backrest (using the handwheel)



Seat with a handwheel

- ▶ Turn handwheel ① forward.

Folding back the front-passenger seat backrest

Please note

⚠ WARNING

If the seat backrest is not engaged, it may fold forwards, e.g. during braking or in the event of an accident.

- As a result, a backrest which is not engaged would press you into the seat belt. The seat belt can no longer offer the intended level of protection and can even cause injuries.
- The backrest cannot restrain objects or loads in the trunk.

There is an increased risk of injury.

Before every journey, make sure that the backrest is engaged as described.

Folding back the front-passenger seat backrest (using the lever)

- ▶ Pull lever ①.
- ▶ Push the seat backrest back at the same time until it engages.

Folding back the front-passenger seat backrest (using the handwheel)

- ▶ Turn handwheel ① back.

Using the trunk partition

Installing the trunk partition

⚠ WARNING

The trunk cover alone cannot retain or secure any heavy objects, items of luggage or heavy loads. You may be struck by unsecured loads in the event of sudden changes in direction, braking or an accident. There is a risk of injury or even fatal injury.

Always stow objects in such a way that they cannot be thrown around. Secure objects, luggage or loads by, for example, lashing them down to prevent them from

slipping or tipping over, even if you use the trunk cover.

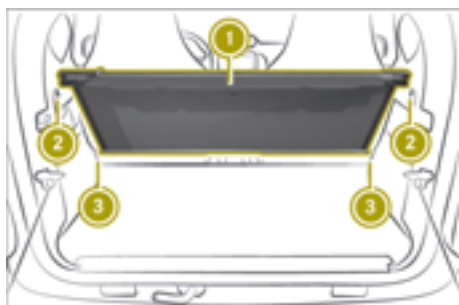

For easier installing, fold the front-passenger seat backrest forward.

- ▶ **smart fortwo coupe:** open the upper and lower tailgate.
- ▶ **smart fortwo cabrio:** open the lower tailgate.
- ▶ **smart fortwo cabrio:** fold the rear soft top up.
- ▶ Hold trunk partition ① with the parcel net bag in the direction of the passenger compartment in the trunk.
- ▶ Insert the trunk partition into bracket ② on the right side.

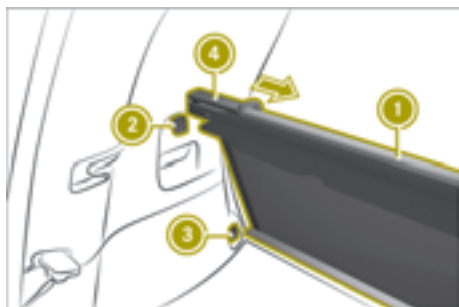

- ▶ Slide handle ④ to the right and hold.
- ▶ Insert the trunk partition into bracket ② on the left side.
- ▶ Release handle.
Trunk partition ① snaps into place.
- ▶ Secure the parcel net bag with the Velcro fasteners.

If the trunk partition is not required and no subwoofer is installed, it can be attached to brackets ③.

Hooking and unhooking the trunk partition



- ▶ Grip trunk partition ① in the center and pull it back.
- ▶ Hook trunk partition into left and right rear brackets ⑤.

Removing/installing the charging cable bag

Removing the charging cable bag

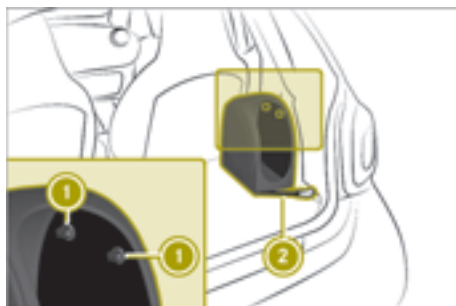

- ▶ Turn both buttons ① to the left.
The buttons are released from the anchorage.
- ▶ Fold the charging cable bag to the left.
The Velcro fasteners under the charging cable bag are detached.
- ▶ Remove snap hook ②.

Installing the charging cable bag

- ▶ Place the charging cable bag with its side resting on the engine compartment cover and then position it on the side trim.
- ▶ Position the charging cable bag in a vertical position.
Take hold of the Velcro fasteners beneath the charging cable bag.
- ▶ Push both buttons ① into the anchorage and turn them to the right.
- ▶ Secure snap hook ②.

Observing the tire and loading information

Instruction labels for tires and loads

⚠ WARNING

Overloaded tires can overheat, causing a blowout. Overloaded tires can also impair the steering and driving characteristics and lead to brake failure. There is a risk of accident.

Observe the load rating of the tires. The load rating must be at least half of the GAWR of your vehicle. Never overload the tires by exceeding the maximum load.



① Information tables on the pillar on the driver's side (B-pillar)

Two instruction labels on the vehicle show the maximum possible load.

- (1) The Tire and Loading Information placard is on the B-pillar on the driver's side. The Tire and Loading Information placard shows the maximum permissible number of occupants and the maximum

permissible vehicle load. It also contains details of the tire sizes and corresponding pressures for tires installed at the factory.

- (2) The vehicle identification plate is on the B-pillar on the driver's side. The vehicle identification plate informs you of the gross weight capacity, called the Gross Vehicle Weight Rating. The Gross Vehicle Weight Rating is made up of the vehicle weight and the load. It also informs you of the front and rear axle weight capacity, called the Gross Axle Weight Rating. The maximum Gross Axle Weight Rating is the maximum weight that can be carried by one axle (front or rear axle). Never exceed the Gross Vehicle Weight Rating or the maximum Gross Axle Weight Rating for the front or rear axle.

Maximum Gross Vehicle Weight Rating

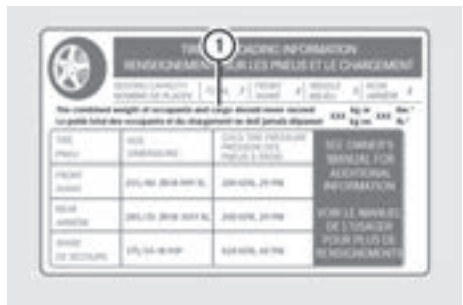

- ▶ The specification for the maximum Gross Vehicle Weight Rating is listed in tire and loading information table ①: "The combined weight of occupants and cargo should never exceed XXX kilograms or XXX lbs."

- i The specifications shown on the Tire and Loading Information placard in the illustration are examples. The maximum Gross Vehicle Weight Rating is vehicle-specific and may differ from that in the illustration. The specification for the maximum Gross Vehicle Weight Rating is listed in the tire and loading information table.

Number of seats

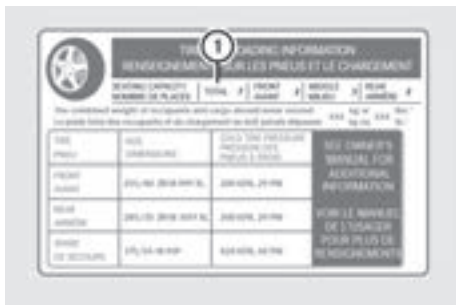

Maximum number of seats ① in the Tire and Loading Information placard, indicates the maximum number of occupants allowed to travel in the vehicle.

i The specifications shown on the Tire and Loading Information placard in the illustration are examples. The number of seats is vehicle-specific and can differ from the details shown. The number of seats for your vehicle can be found on your vehicle's tire and loading information table.

Determining the correct load limit

The following steps have been developed as required of all manufacturers under Title 49, Code of U.S. Federal Regulations, Part 575 pursuant to the "National Traffic and Motor Vehicle Safety Act of 1966".

- ▶ **Step 1:** Locate the statement "The combined weight of occupants and cargo should never exceed XXX kg or XXX lbs." on your vehicle's tire and loading information table.
- ▶ **Step 2:** Determine the combined weight of the driver and passengers that will be riding in your vehicle.
- ▶ **Step 3:** Subtract the combined weight of the driver and passengers from XXX kg or XXX lbs.
- ▶ **Step 4:** The resulting figure equals the available amount of cargo and luggage load capacity. For example: at a sum "XXX" of 1400 lbs and five occupants each weighing 150 lbs, the amount of available cargo

and luggage load capacity is 650 lbs (1400 - 750 (5 x 150) = 650 lbs).

- ▶ **Step 5:** Determine the combined weight of luggage and cargo being loaded on the vehicle. That weight may not safely exceed the available cargo and luggage load capacity calculated in step 4.

Example: steps 1 to 3

The following table shows examples on how to calculate total and cargo load capacities with varying seating configurations and number and size of occupants. The following examples use a load limit of 1500 lbs (680 kg).

This is for illustration purposes only. Make sure you are using the actual load limit for your vehicle stated on your vehicle's Tire and Loading Information placard (▷ page 121).

The greater the combined weight of the occupants, the lower the maximum luggage load.

Step 1

	Example 1	Example 2	Example 3
Combined maximum weight of occupants and cargo (data from the Tire and Loading Information placard)	1500 lbs (680 kg)	1500 lbs (680 kg)	1500 lbs (680 kg)

Step 2

	Example 1	Example 2	Example 3
Number of people in the vehicle (driver and occupants)	5	3	1
Distribution of the occupants	Front: 2 Rear: 3	Front: 1 Rear: 2	Front: 1

	Example 1	Example 2	Example 3
Weight of the occupants	Occupant 1: 150 lbs (68 kg) Occupant 2: 180 lbs (82 kg) Occupant 3: 160 lbs (73 kg) Occupant 4: 140 lbs (63 kg) Occupant 5: 120 lbs (54 kg)	Occupant 1: 200 lbs (91 kg) Occupant 2: 190 lbs (86 kg) Occupant 3: 150 lbs (68 kg)	Occupant 1: 150 lbs (68 kg)
Gross weight of all occupants	750 lbs (340 kg)	540 lbs (245 kg)	150 lbs (68 kg)

Step 3

	Example 1	Example 2	Example 3
Permissible load (maximum Gross Vehicle Weight Rating from the Tire and Loading Information placard minus the gross weight of all occupants)	1500 lbs (680 kg) -750 lbs (340 kg) = 750 lbs (340 kg)	1500 lbs (680 kg) -540 lbs (245 kg) = 960 lbs (435 kg)	1500 lbs (680 kg) -150 lbs (68 kg) = 1350 lbs (612 kg)

Vehicle identification plate

Even if you have calculated the total load carefully, you should still make sure that the Gross Vehicle Weight Rating and the Gross Axle Weight Rating are not exceeded. Details can be found on the vehicle identification plate on the pillar on the driver's side (B-pillar).

Gross Vehicle Weight Rating: the gross weight of the vehicle, all passengers, load and trailer load/noseweight (if applicable) must not exceed the permissible gross vehicle weight.

Gross Axle Weight Rating: the maximum permissible weight that can be carried by one axle (front or rear axle).

To ensure that the vehicle does not exceed the maximum permissible values (Gross Vehicle Weight Rating and Gross Axle Weight Rating), have your loaded vehicle (including driver, passengers, load and full trailer load, if applicable) weighed on a suitable vehicle weighbridge.

Useful information

The engine compartment in the smart is located at the rear, below the trunk. The reservoirs for service fluids are located under the service cover at the front.

When working on the vehicle, always comply with all safety regulations. Always have work in the engine compartment carried out at a qualified specialist workshop.

Removing/installing the subwoofer

Removing the subwoofer

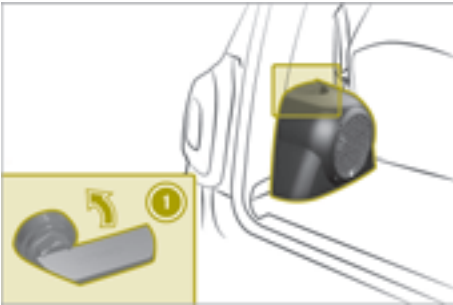

- ▶ Release quick-release fastener ① in the direction of the arrow.
- ▶ Reach into the recess on the quick-release fastener.
- ▶ Detach, tilt and pull the subwoofer to the right.
- ▶ Pull out the connector.

Installing the subwoofer

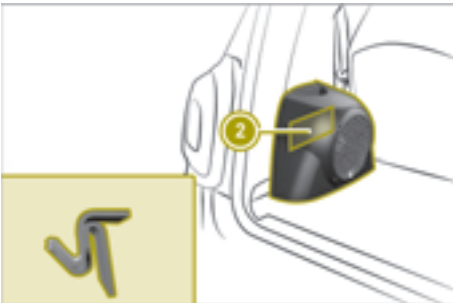

- ▶ Insert the connector.
- ▶ Place the subwoofer at the base of the side trim.
- ▶ Turn quick-release fastener ① upwards.
- ▶ Press the bracket into the recess in side trim ②.
- ▶ Turn quick-release fastener ① clockwise.

Opening and closing the service cover

Please note

⚠ WARNING

If the service cover is not locked, it may come loose during driving and block your view or endanger other road users. There is a risk of an accident and injury.

Therefore, make sure that the service cover is locked before every journey.

⚠ WARNING

If the windshield wipers begin to operate while the service cover is open, there is a danger of injury from the wiper arms. There is a risk of injury.

Always switch off the windshield wipers and the ignition before opening the service cover.

- ❗ To ensure unhindered air intake, carefully remove any snow or dirt from the ventilation slots above the service cover.

The vehicle must be secured against rolling away.

Unlocking the service cover

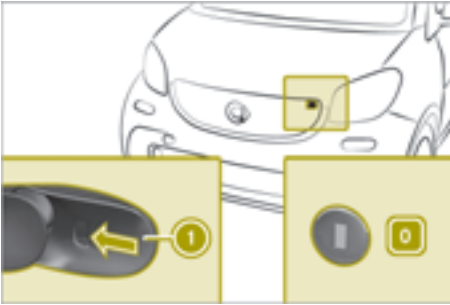

- ▶ Remove lock cover (1) on driver's side.
- ▶ Insert the SmartKey into the lock and turn it to position [0].

Opening the service cover

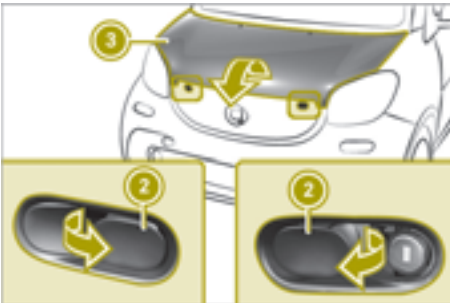

- ▶ Pull both levers (2) in the direction of the arrow.
- ▶ Lift service cover (3) at the front.
- ▶ Pull service cover (3) slightly forward and lift it up.
- ▶ Lean service cover (3) attached by the straps, carefully on the front of the vehicle.

Closing the service cover

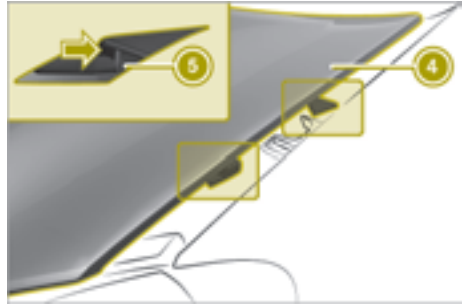

- ▶ Lift service cover (3).
- ▶ Slide bars (5) on the left and right of the service cover under the bars on fender (4).

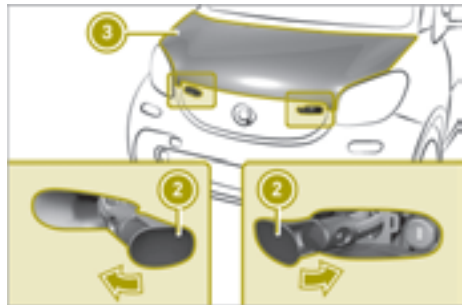

- ▶ Press service cover (3) down.
- ▶ Press both levers (2) back in the direction of the arrow.

Locking the service cover

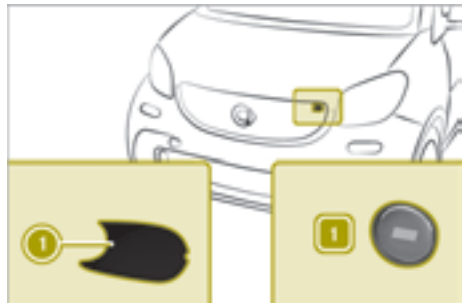

- ▶ Insert the SmartKey into the lock and turn it to position [1].
- ▶ Insert lock cover (1) on the driver's side and snap it into place.

Checking and adding service products

Please note

WARNING

Service products may be poisonous and hazardous to health. There is a risk of injury.

Comply with instructions on the use, storage and disposal of service products on the labels of the respective original containers. Always store service products sealed in their original containers. Always keep service products out of the reach of children.

Environmental note

Dispose of service products in an environmentally responsible manner.

Also observe the safety notes in the "Service products" section (▷ page 181).

Service products include the following:

- Coolant
- Brake fluid
- Windshield washer fluid
- Climate control system refrigerant

Service products approved by smart: <http://bevo.mercedes-benz.com>

Checking and adding coolant

Checking the coolant level

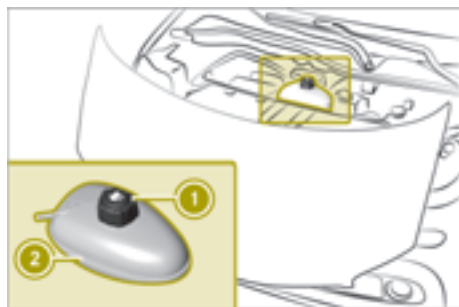

- ▶ Stop the vehicle on a level surface.
- ▶ Let the coolant cool down for at least 30 minutes.

- ▶ Open the service cover.
- ▶ Check reservoir ② visually.
The fluid level must be between the MIN mark and the MAX mark.

Adding coolant

WARNING

The cooling system is pressurized when the drive system is at operating temperature. When you open the cap, you could be scalded by hot coolant spraying out. There is a risk of injury.

Let the drive system cool down before you open the cap. Wear gloves and eye protection when opening. Open the cap slowly to relieve pressure.

- ❗ Only add coolant that has been premixed with the desired antifreeze protection. You could otherwise damage the engine.

Further information on coolants can be found in the Mercedes-Benz Specifications for Service Products, MB BeVo 310.1, e.g. on the Internet at <http://bevo.mercedes-benz.com>. Or contact a qualified specialist workshop.

If the coolant has antifreeze protection down to -35 °F (-37 °C), the boiling point of the coolant during operation is approximately 266 °F (130 °C).

The antifreeze/corrosion inhibitor concentration in the engine cooling system should be 50% -35 °F (-37 °C)). This will protect the engine cooling system against freezing down to around -13 °F (-25 °C).

- ▶ Cover cap ① of coolant expansion tank ② with a cloth.
- ▶ Turn the cap slowly one half turn. If necessary, allow excess pressure to escape.
- ▶ Turn the cap further and remove it.
- ▶ Refill coolant to the MAX level.
- ▶ Replace the cap and tighten it as far as it will go.
- ▶ Close the service cover.

- i See "Technical data" for information on recommended coolants.

Adding washer fluid

WARNING

Windshield washer concentrate is highly flammable. If it comes into contact with hot components in the front compartment, it may ignite. There is a risk of fire and injury.

Make sure that no windshield washer concentrate is spilled next to the filler neck.

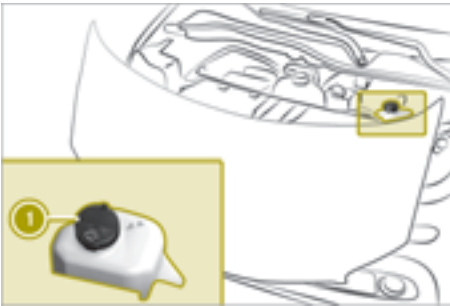

- ▶ Open the service cover.
- ▶ Pull cap ① up at the tab.
- ▶ If available, pull the removable nozzle up as far as the stop.
- ▶ Add washer fluid.
- ▶ If available, push the removable nozzle down and push it inside.
- ▶ Replace and tightly screw on cap ①.
- ▶ Close the service cover.

 See "Technical data" for information on windshield washer fluid and antifreeze.

Checking wheels and tires

Warning

A flat tire severely impairs the driving, steering and braking characteristics of the vehicle. There is a risk of an accident.

do not drive with a flat tire. Immediately replace the flat tire with your spare wheel, or consult a qualified specialist workshop.

WARNING

Damaged tires can cause tire inflation pressure loss. As a result, you could lose control of your vehicle. There is a risk of accident.

Check the tires regularly for signs of damage and replace any damaged tires immediately.

WARNING

Insufficient tire tread will reduce tire traction. The tire is no longer able to dissipate water. This means that on wet road surfaces, the risk of hydroplaning increases, in particular where speed is not adapted to suit the driving conditions. There is a risk of accident.

If the tire pressure is too high or too low, tires may exhibit different levels of wear at different locations on the tire tread. Thus, you should regularly check the tread depth and the condition of the tread across the entire width of all tires.

Minimum tire tread depth for:

- Summer tires: $\frac{1}{8}$ in (3 mm)
- M+S tires: $\frac{1}{6}$ in (4 mm)

For safety reasons, replace the tires before the legally prescribed limit for the minimum tire tread depth is reached.

 If unavoidable, you should drive over obstacles such as curbs slowly and not at a sharp angle. Otherwise, you may damage the wheels or tires.

Check the wheels and tires for damage at least once a month, as well as after driving off-road or on poorly surfaced roads.

Break in new tires at moderate speeds for the first 60 miles (100 km), as they only reach their full performance after this distance.

Vibrations, audible noises or unusual handling characteristics, e.g. pulling to one side, may indicate that the wheels or tires are damaged.

If you suspect a tire defect:

- ▶ Reduce vehicle speed.
 - ▶ Stop the vehicle as soon as possible.
 - ▶ Check the wheels and tires for damage.
- If you find no signs of damage, have the wheels and tires checked at a qualified specialist workshop.

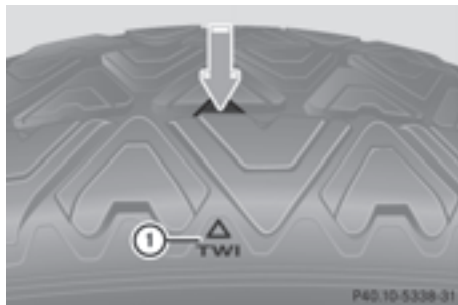

Indicator ① shows which position the bar marking (arrow) for tread wear is integrated into the tire tread.

Treadwear indicators (TWI) are required by law. Six indicators are positioned on the tire tread. They are visible once a tread depth of approximately $\frac{1}{16}$ in (1.6 mm) has been reached. If this is the case, the tire is so worn that it must be replaced.

Obtaining information on tires

Uniform Tire Quality Grading Standards

Overview of Tire Quality Grading Standards

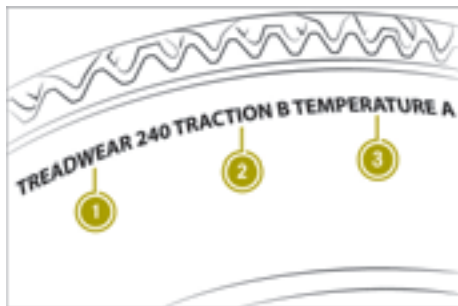

Uniform Tire Quality Grading Standards are U.S. government specifications. Their pur-

pose is to provide drivers with uniform reliable information on tire performance data.

Tire manufacturers must grade tires using three performance factors:

- ① Treadwear grade
- ② Traction grade
- ③ Temperature grade

These regulations do not apply to Canada. Nevertheless, all tires sold in North America are provided with the corresponding quality grading markings on the sidewall of the tire.

Quality grades can be found, where applicable, on the tire sidewall between the tread shoulder and maximum tire width.

Example:

- Treadwear grade: 200
- Traction grade: AA
- Temperature grade: A

All passenger car tires must conform to the statutory safety requirements in addition to these grades.

- ① The actual values for tires are vehicle-specific and may deviate from the values in the illustration.

Treadwear

The treadwear grade is a comparative rating based on the wear rate of the tire when tested under controlled conditions on a specified U.S. government course. For example, a tire graded 150 would wear one and one-half times as well on the government test track as a tire graded 100.

The relative performance of tires depends upon the actual conditions of their use, however, and may depart significantly from the norm due to variations in driving habits, service practices and differences in road characteristics and climate conditions.

Traction

⚠ WARNING

The traction grade assigned to this tire is based on straight-ahead braking traction tests, and does not include acceleration, cornering, hydroplaning, or peak traction characteristics.

! Avoid wheelspin. This can lead to damage to the drive train.

The traction grades, from highest to lowest, are AA, A, B and C. These grades represent the tire's ability to stop on wet surfaces, as measured under controlled conditions on specified government test surfaces of asphalt and concrete. A tire marked C may have poor traction performance.

The safe speed on a wet, snow covered or icy road is always lower than on dry road surfaces.

The drivers must pay special attention to road conditions when temperatures are around freezing point.

smart recommends a minimum tread depth of $\frac{1}{8}$ in (4 mm) on all four winter tires. The legally required minimum tread depth must be observed. Winter tires can reduce the braking distance on snow-covered surfaces in comparison with summer tires. The braking distance is still much further than on surfaces that are not icy or covered with snow. Therefore take appropriate care when driving.

Temperature

⚠ WARNING

The temperature grade for this tire is established for a tire that is properly inflated and not overloaded. Excessive speed, underinflation, or excessive loading, either separately or in combination, can cause excessive heat build-up and possible tire failure.

The temperature grades are A (the highest), B and C. They represent the tire's resistance to the generation of heat and its ability to dissipate heat when tested under controlled conditions on a specified indoor laboratory test wheel. Sustained high temperature can cause the material of the tire to degenerate and reduce tire life, and excessive temperature can lead to sudden tire failure. The grade C corresponds to a level of performance which all passenger car tires must meet under the Federal Motor Vehicle Safety Standard No. 109. Grades B and A represent higher levels of performance on the labora-

tory test wheel than the minimum required by law.

Tire labeling

Overview

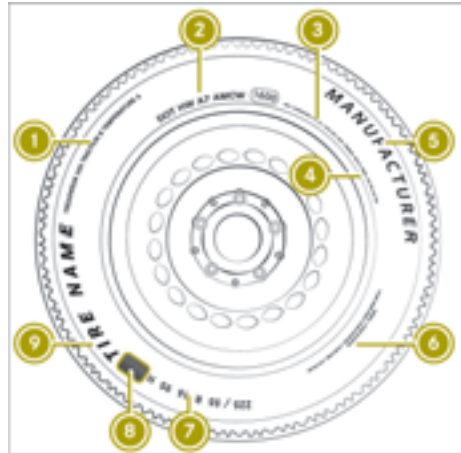

- ① Uniform Tire Quality Grading Standard
- ② DOT, Tire Identification Number
- ③ Maximum load rating
- ④ Maximum tire pressures
- ⑤ Manufacturer
- ⑥ Tire material
- ⑦ Tire size designation, load-bearing capacity and speed rating
- ⑧ Load index
- ⑨ Tire name

i Tire data is vehicle-specific and may deviate from the data in the example.

Tire size designation, load-bearing capacity and speed rating

⚠ WARNING

Exceeding the stated tire load-bearing capacity and the approved maximum speed could lead to tire damage or the tire bursting. There is a risk of accident.

Therefore, only use tire types and sizes approved for your vehicle model. Observe

the tire load rating and speed rating required for your vehicle.

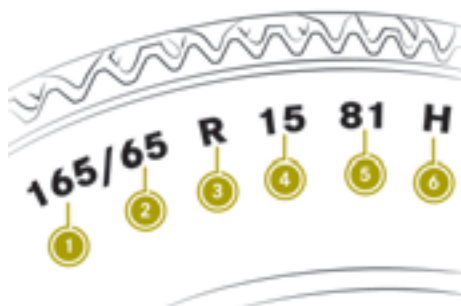

- ① Tire width in mm
- ② Nominal aspect ratio in %
- ③ Tire code
- ④ Rim diameter
- ⑤ Load bearing index
- ⑥ Speed rating

General information: depending on the manufacturer's standards, the size imprinted in the tire wall may also contain a letter that precedes the size description.

- No letter: passenger vehicle tires according to European manufacturing standards.
- Letter P: passenger vehicle tires according to US manufacturing standards.
- Letters LT: light truck tires according to US manufacturing standards.
- Letter T: compact emergency wheels with high tire pressure that are only designed for temporary use in an emergency.

Tire width: tire width ① shows the nominal tire width in millimeters.

Height-width ratio: aspect ratio ② is the size ratio between the tire height and tire width and is shown in percent. The aspect ratio is calculated by dividing the tire width by the tire height.

Tire code: tire code ③ specifies the tire type.

- R: radial tires
- D: diagonal tires
- B: diagonal radial tires
- ZR: optional, depending on the manufacturer, for tires with a maximum speed of over 149 mph (240 km/h), e.g. 245/40 ZR 18

Rim diameter: rim diameter ④ is the diameter of the bead seat and is given in inches (in).

Load-bearing index: load-bearing index ⑤ is a numerical code that specifies the maximum load-bearing capacity of a tire. Load-bearing index 91 indicates a maximum load of 1,356 lb (615 kg) that the tires can bear. Do not overload the tires by exceeding the specified load limit. The maximum permissible load is located on the vehicle's Tire and Loading Information placard on the B-pillar on the driver's side.

Speed rating: speed rating ⑥ specifies the approved maximum speed of the tire.

Summer tires

Index	Speed rating
Q	up to 100 mph (160 km/h)
R	up to 106 mph (170 km/h)
S	up to 112 mph (180 km/h)
T	up to 118 mph (190 km/h)
H	up to 130 mph (210 km/h)
V	up to 149 mph (240 km/h)
W	up to 168 mph (270 km/h)
Y	up to 186 mph (300 km/h)
ZR...Y	up to 186 mph (300 km/h)
ZR...(..Y)	over 186 mph (300 km/h)
ZR	over 149 mph (240 km/h)

The service specification is made up of load-bearing index ⑤ and speed rating ⑥.

If the size description of the tire includes "ZR" and there are no service specifications, contact the tire manufacturer in order to find out the maximum speed.

If a service specification is available, the maximum speed is limited according to the speed rating in the service specification. Example: 245/40 ZR18 97 Y. In this example, "97 Y" is the service specification. The letter "Y" represents the speed rating. The maximum speed of the tire is limited to 186 mph (300 km/h).

The size description for all tires with maximum speeds of over 186 mph (300 km/h) must

include "ZR", and the service specification must be given in parentheses. Example: 275/40 ZR 18 (99 Y). Speed rating "(Y)" indicates that the maximum speed of the tire is over 186 mph (300 km/h). Consult the tire manufacturer to find out the maximum speed.

All-weather tires and winter tires

Index	Speed rating
Q M+S ⁵	up to 100 mph (160 km/h)
T M+S ⁵	up to 118 mph (190 km/h)
H M+S ⁵	up to 130 mph (210 km/h)
V M+S ⁵	up to 149 mph (240 km/h)

i Not all tires with the M+S marking provide the driving characteristics of winter tires. In addition to the M+S marking, winter tires also have the  snowflake symbol on the tire wall. Tires with this marking fulfill the requirements of the Rubber Manufacturers Association (RMA) and the Rubber Association of Canada (RAC) regarding the tire traction on snow. They have been especially developed for driving on snow.

An electronic speed limiter prevents the vehicle from exceeding a speed of 130 mph (210 km/h).

The speed rating of tires mounted at the factory may be higher than the maximum speed that the electronic speed limiter permits.

The driver must ensure that the tires have the required speed rating, e.g. with new tires. For the required speed rating for the vehicle, see (▷ page 129).

Further information about reading tire data is available from any qualified specialist workshop.

Load index



In addition to the load-bearing index, load identification **1** may also be imprinted on the sidewall of the tire.

- No text: standard load (SL) tire.
- XL or Extra Load: extra load or reinforced tire.
- Light Load: light load tire.
- C, D, E: load range that depends on the maximum load that the tire can carry at a certain pressure.

Maximum load rating



Maximum tire load **1** is the maximum permissible weight for which the tire is approved.

Do not overload the tires by exceeding the specified load limit. The maximum permissible load is located on the vehicle's Tire and Loading Information placard on the B-pillar on the driver's side.

⁵ Or M+S  for winter tires.

DOT, Tire Identification Number (TIN)

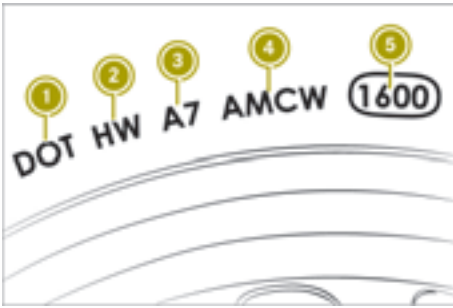

- ① DOT (Department of Transportation)
- ② Manufacturer identification code
- ③ Tire size
- ④ Tire type code
- ⑤ Date of manufacture

U.S tire regulations prescribe that every tire manufacturer or retreader must imprint a TIN in or on the sidewall of every tire produced.

The TIN is a unique identification number. The TIN enables the tire manufacturers or retreaders to inform purchasers of recalls and other safety-relevant matters. It makes it possible for the purchaser to easily identify the affected tires.

DOT (Department of Transportation) ① indicates that the tire complies with the requirements of the United States Department of Transportation.

Manufacturer identification code ② provides details on the tire manufacturer. New tires have a code with two symbols. Retreaded tires have a code with four symbols.

Tire type code ④ can be used by the manufacturer as a code to describe specific characteristics of the tire.

Date of manufacture ⑤ provides information about the age of a tire. The first and second positions represent the week of manufacture, starting with "01" for the first calendar week. Positions three and four represent the year of manufacture. For example, a tire that is marked with "3208", was manufactured in week 32 in 2008.

Tire characteristics

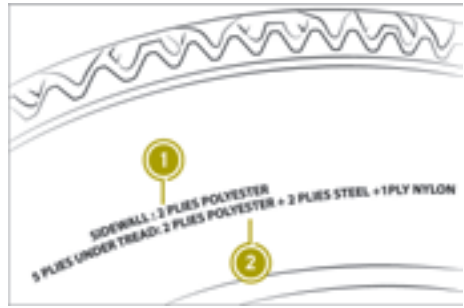

- ① Tire cord and the number of layers in the side wall
- ② Tire cord and the number of layers under the tread

Definition of terms for tires and loading

Tire ply composition and material used

Describes the number of plies or the number of layers of rubber-coated fabric in the tire tread and sidewall. These are made of steel, nylon, polyester and other materials.

Bar

Metric unit for tire pressure. 14.5038 pounds per square inch (psi) and 100 kilopascals (kPa) are the equivalent of 1 bar.

DOT (Department of Transportation)

DOT marked tires fulfill the requirements of the United States Department of Transportation.

Normal occupant weight

The number of occupants for which the vehicle is designed multiplied by 68 kilograms (150 lbs).

Uniform Tire Quality Grading Standards

A uniform standard to grade the quality of tires with regards to tread quality, tire traction and temperature characteristics. The quality grading assessment is made by the manufacturer following specifications from the U.S. government. The ratings are molded into the sidewall of the tire.

Recommended tire pressures

The recommended tire pressure applies to the tires mounted at the factory.

The Tire and Loading Information placard contains the recommended tire pressures for cold tires on a fully loaded vehicle and for the maximum permissible vehicle speed.

The tire pressure table contains the recommended tire pressure for cold tires under various operating conditions, i.e. loading and speed of the vehicle.

Increased vehicle weight due to optional equipment

The combined weight of all standard and optional equipment available for the vehicle, regardless of whether it is actually installed on the vehicle or not.

Rim

This is the part of the wheel on which the tire is mounted.

GAWR (Gross Axle Weight Rating)

The GAWR is the maximum gross axle weight rating. The actual load on an axle must not exceed the gross axle weight rating. The maximum gross axle weight rating is located on the vehicle identification plate on the B-pillar on the driver's side.

Speed rating

The speed rating is part of the tire identification. It specifies the speed range for which the tire is approved.

GVW (Gross Vehicle Weight)

The gross vehicle weight includes the weight of the vehicle including tools, the spare wheel, accessories installed, occupants, luggage and the drawbar noseweight, if applicable. The gross vehicle weight must not exceed the gross vehicle weight rating GVWR as specified on the vehicle identification plate on the B-pillar on the driver's side.

GVWR (Gross Vehicle Weight Rating)

The GVWR is the maximum permitted gross weight of the fully laden vehicle (weight of the vehicle including all accessories, occupants, luggage and the drawbar noseweight, if applicable). The gross vehicle weight rating is specified on the vehicle identification plate on the B-pillar on the driver's side.

Maximum loaded vehicle weight

The maximum weight is the sum of the following factors:

- the curb weight of the vehicle
- weight of accessories
- the load limit
- the weight of the factory installed optional equipment

Kilopascal (kPa)

Metric unit for tire pressure. 6.9 kPa corresponds to 1 psi. Another unit for tire pressure is bar. 100 kilopascals (kPa) are the equivalent of 1 bar.

Load index

In addition to the load-bearing index, the load index may also be imprinted on the sidewall of the tire. This specifies the load-bearing capacity of the tire more precisely.

Curb weight

The weight of a vehicle with standard equipment including the maximum capacity of coolant. It also includes the air-conditioning system and optional equipment if these are installed in the vehicle, but does not include passengers or luggage.

Maximum load rating

The maximum load rating is the maximum permissible weight in kilograms or pounds for which a tire is approved.

Maximum permissible tire pressure

Maximum permissible tire pressure for one tire.

Maximum load on one tire

Maximum load on one tire. This is calculated by dividing the maximum axle load of one axle by two.

PSI (pounds per square inch)

A standard unit of measure for tire pressure.

Aspect ratio

Relationship between tire height and tire width in percent.

Tire pressure

This is pressure inside the tire applying an outward force to each square inch of the tire's surface. The tire pressure is specified in pounds per square inch (psi), in kilopascal (kPa) or in bar. The tire pressure should only be corrected when the tires are cold.

Cold tire pressure

The tires are considered to be cold in the following conditions:

- If the vehicle has been parked with the tires out of direct sunlight for at least three hours.
- If the vehicle has not been driven further than 1 mile (1.6 km)

Tread

The part of the tire that comes into contact with the road.

Bead

The tire bead ensures that the tire sits securely on the wheel. There are several steel wires in the bead to prevent the tire from coming loose from the wheel rim.

Sidewall

The part of the tire between the tread and the bead.

Weight of optional extras

The combined weight of those optional extras that weigh more than the replaced standard parts and more than 5 lbs (2.3 kilograms). These optional extras, such as high-performance brakes, level control, a roof rack or a high-voltage battery, are not included in the curb weight and the weight of the accessories.

TIN (Tire Identification Number)

This is a unique identifier which can be used by a tire manufacturer to identify tires, for example for a product recall, and thus identify the purchasers. The TIN is made up of the manufacturer's identity code, tire size, tire type code and the manufacturing date.

Load bearing index

The load-bearing index is a code that contains the maximum load bearing capacity of a tire.

Traction

Traction is the result of friction between the tires and the road surface.

Treadwear indicators

Narrow bars (tread wear bars) that are distributed over the tire tread. If the tire tread is level with the bars, the wear limit of $\frac{1}{16}$ in (1.6 mm) has been reached.

Occupant distribution

The distribution of occupants in a vehicle at their designated seating positions.

Total load limit

Nominal load and luggage load plus 68 kg (150 lbs) multiplied by the number of seats in the vehicle.

Changing a wheel

Please note

WARNING

Interchanging the front and rear wheels may severely impair the driving characteristics if the wheels or tires have different dimensions. The wheel brakes or suspension components may also be damaged. There is a risk of accident.

Rotate front and rear wheels only if the wheels and tires are of the same dimensions.

WARNING

If wheels and tires of the wrong size are used, the wheel brakes or suspension components may be damaged. There is a risk of an accident.

Always replace wheels and tires with those that fulfill the specifications of the original part.

When replacing wheels, make sure to use the correct:

- designation
- model

When replacing tires, make sure to use the correct:

- designation
- manufacturer
- model

! If your vehicle is equipped with the tire pressure monitor, each wheel has an electronic component.

Tire-mounting tools should not be applied in the area of the valve. Otherwise, the electronic components could be damaged. Only have tires replaced at a qualified specialist workshop.

! Position a suitable jack only on the jacking points intended for this purpose. Raise the vehicle for a short time only to change the wheel. Make sure the vehicle is on a suitable surface and that no-one is in the vehicle. Secure the vehicle using chocks and apply the parking brake.

Rules for selecting new tires

! For safety reasons, smart recommends that you only use tires and wheels which have been specifically approved by smart for your vehicle. These are specially adapted to the control systems, such as ABS or ESP®.

Only use tires and wheels specifically tested and approved by smart. Certain characteristics, e.g. handling, vehicle noise emissions or fuel consumption, may otherwise be adversely affected. In addition, when driving with a load, dimensional variations and different tire deformation characteristics could cause the tires to make contact with the bodywork and axle components. This could result in damage to the tires or the vehicle.

smart accepts no liability for damage resulting from the use of tires or wheels other than those tested and approved.

Information on wheels and tires can be obtained at a qualified specialist workshop, e.g. a smart center.

The service life of tires depends on various factors, including the following:

- Driving style
- Tire pressure
- Distance covered

Observe the following rules for selecting new tires:

- Only mount tires and wheels of the same type and make.
- Only tires of the same size may be used on a single axle (left/right).
- Only use tires of the same type (summer tires, all-season tires, winter tires).
- Use only wheel/tire combinations approved by smart.
- Do not wear tires out too much, as this significantly reduces the traction on wet roads (hydroplaning).
- Replace tires after six years at the latest.

i Recommended tire pressure for various operating states can be found on the tire pressure table on the door pillar (B-pillar) on the driver's side.

You can find further information regarding tires at specialist tire retailers, at qualified specialist workshops or at any smart center.

Preparing to change a wheel

The vehicle tool tray is located under the glove box.

- ▶ Stop the vehicle on solid, non-slippery and level ground.
- ▶ Apply the parking brake.
- ▶ Position the front wheels to point straight ahead.
- ▶ Shift the transmission to position **P**.
- ▶ Switch off the engine.
- ▶ Remove SmartKey from ignition lock.
- ▶ Secure the vehicle against rolling away.

Removing a wheel

WARNING

If you do not position the jack correctly at the appropriate jacking point of the vehi-

cle, the jack could tip over with the vehicle raised. There is a risk of injury.

Only position the jack at the appropriate jacking point of the vehicle. The base of the jack must be positioned vertically, directly under the jacking point of the vehicle.

! Do not place wheel bolts in sand or on a dirty surface. The bolt and wheel hub threads could otherwise be damaged when you screw them in.

! Position a suitable jack only on the jacking points intended for this purpose.

Never position the jack on the high-voltage battery. Do not jack up the vehicle on the high-voltage battery. There is otherwise a risk of damaging the high-voltage battery.

Also observe the notes in the "Changing a wheel" section.

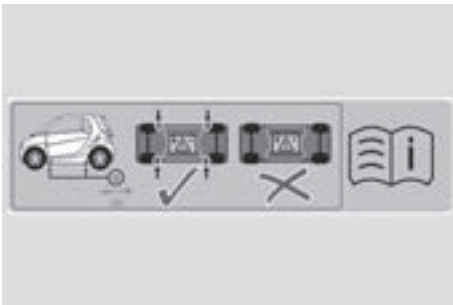

Warning stickers

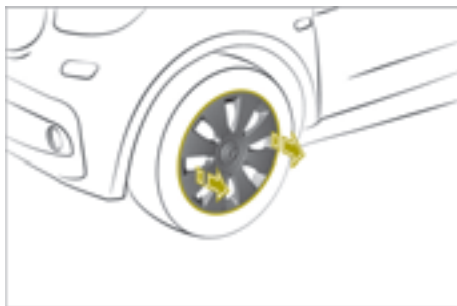

Vehicles with steel wheels and hub caps:

- ▶ Using both hands, grasp two hub cap openings and remove the hub cap.

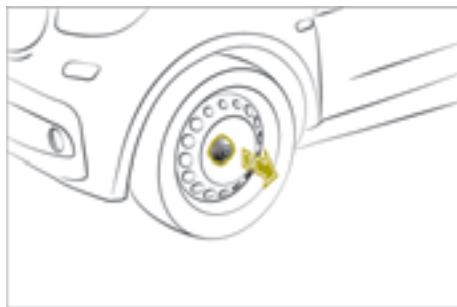

Vehicles with steel wheels and hub cap covers:

- ▶ Remove the wheel hub cover.

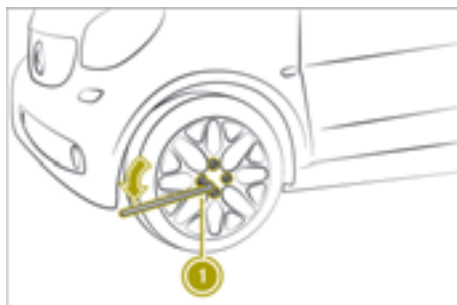

- ▶ Using lug wrench (1) loosen the wheel bolts by about one turn. Do not unscrew the wheel bolts completely.

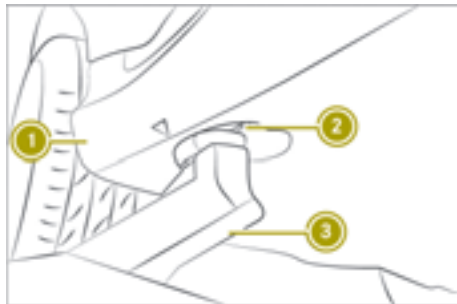

The vehicle may only be raised at the designated jacking points. Points (2) are to the front and back in the immediate vicinity of the wheels. Do not position jack (3) on the edge of sill (1). Otherwise, damage to the vehicle could occur.

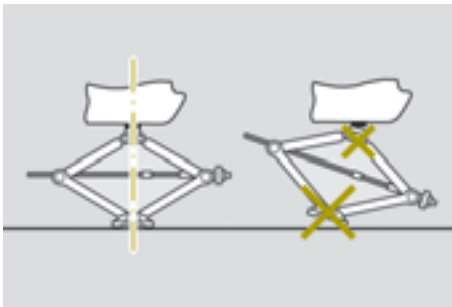
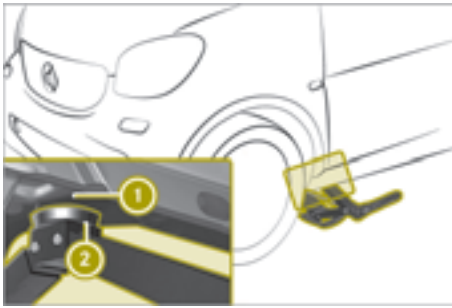

- ▶ Position jack (2) behind the triangular indentations for jacking point (1) on the longitudinal body member.
- ▶ Set the foot of the jack up vertically with respect to the jacking point on the vehicle.
- ▶ Raise the vehicle using the jack until the tire is a maximum of 1.2 in (3 cm) off the ground.
- ▶ Unscrew and remove the wheel bolts.
- ▶ Remove the wheel.

Mounting a wheel

WARNING

The wheels could work loose if the wheel nuts and bolts are not tightened to the specified tightening torque. There is a risk of accident.

Have the tightening torque immediately checked at a qualified specialist workshop after a wheel is changed.

WARNING

If you tighten the wheel bolts or wheel nuts when the vehicle is raised, the jack could tip over. There is a risk of injury.

Only tighten the wheel bolts or wheel nuts when the vehicle is on the ground.

 When changing a wheel, use only wheel bolts that have been approved for the wheel rim and vehicle.

 To prevent damage to the paintwork, hold the wheel securely against the wheel hub while screwing in the first wheel bolt.

Always pay attention to the instructions and safety notes on "Changing a wheel"

(▷ page 134).



Mount tires with a specified direction of rotation only according to their direction of rotation. An arrow on the sidewall of the tire indicates its correct direction of rotation.

- ▶ Clean the wheel and wheel hub contact surfaces.
- ▶ Push the wheel onto the wheel hub and press it on.
- ▶ Screw in the wheel bolts and tighten them slightly.

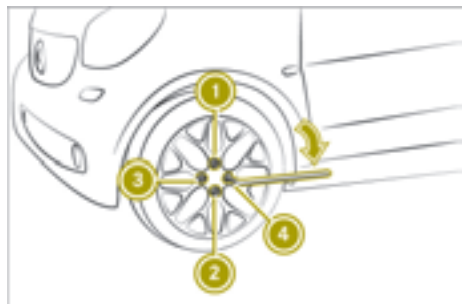

- ▶ Lower the vehicle all the way.
- ▶ Remove the jack.
- ▶ Tighten the wheel bolts evenly in a cross-wise pattern in sequence indicated ① to ④. The tightening torque must be 77 lb-ft (105 Nm).
- ▶ Check the recommended tire pressure and adjust if necessary.
- ① Vehicles with tire pressure monitor: all wheels mounted must be equipped with functioning sensors.

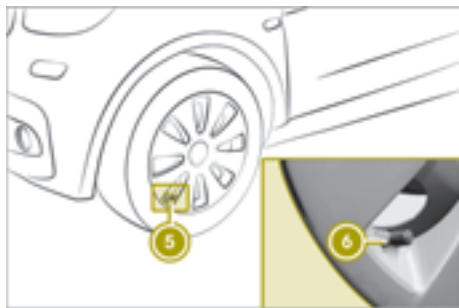

Vehicles with steel wheels and hub caps:

- ▶ Mount hub cap ⑤ such that valve ⑥ does not become trapped.
- ▶ Press the hub cap evenly onto the wheel with both hands until you hear the hub cap engage.
- ▶ Check to make sure the hub cap is seated securely on the wheel.

Vehicle with steel wheels and wheel hub covers:

- ▶ Mount the wheel hub cover.

Storing wheels

- ▶ Store wheels in a cool, dry and dark place when not in use.
- ▶ Protect against oil, grease and fuel.

Using the tire pressure monitor

Useful information

- ① This function is only available in the USA.

⚠ WARNING

Each tire, including the spare (if provided), should be checked at least once every two weeks when cold and inflated to the pressure recommended by the vehicle manufacturer on the Tire and Loading Information placard on the driver's door B-pillar or the tire pressure label on the inside of the fuel filler flap. If your vehicle has tires of a different size than the size indicated on the Tire and Loading Information placard or, if available, the tire pressure label, you should determine the proper tire pressure for those tires.

As an added safety feature, your vehicle has been equipped with a tire pressure monitoring system (TPMS) that illuminates a low tire pressure telltale when one or more of your tires are significantly underinflated. Accordingly, when the low tire pressure telltale lights up, you should stop and check your tires as soon as possible, and inflate them to the proper pressure. Driving on a significantly underinflated tire causes the tire to overheat and can lead to tire failure.

Underinflation also reduces fuel efficiency and tire tread life, and may affect the vehicle's handling and stopping ability. Please note that the TPMS is not a substitute for proper tire maintenance, and it is the driver's responsibility to maintain correct tire pressure, even if underinflation has not reached the level to trigger illumination of the TPMS low tire pressure telltale.

Your vehicle has also been equipped with a TPMS malfunction indicator to indicate when the system is not operating properly. The TPMS malfunction indicator is combined with the low tire pressure telltale. When the system detects a malfunction, the warning lamp will flash for approximately a minute and then remain continuously illuminated. This sequence will be repeated every time the vehicle is started as long as the malfunction exists. When the malfunction indicator is illuminated, the

system may not be able to detect or signal low tire pressure as intended.

TPMS malfunctions may occur for a variety of reasons, including the installation of incompatible replacement or alternate tires or wheels on the vehicle that prevent the TPMS from functioning properly.

Always check the TPMS malfunction tell-tale after replacing one or more tires or wheels on your vehicle to ensure that the replacement or alternate Tires and wheels allow the TPMS to continue to function properly.

It is the driver's responsibility to set the tire pressure to that recommended for cold tires which is suitable for the operating situation. The tire pressure monitor issues a warning when the pressure drops in one or more of the tires.

The tire pressure monitor only functions if sensors are present in all four tires, and after the monitor has learned the correct tire pressure for the current operating situation. In most cases, this occurs automatically, but may also be specified after restarting the tire pressure monitor. Before restarting, check the tires for the recommended tire pressure.

The tire pressure monitor does not provide a warning in the following cases:

- Even loss of pressure on multiple tires
- Sudden loss of tire pressure, e.g. due to penetration by a foreign body
- Incorrectly set tire pressure

The tire pressure monitor has a yellow warning lamp in the instrument cluster for indicating pressure loss and malfunction.

Restarting the tire pressure monitor

- ▶ Set the tire pressure of all tires to the recommended value.
- ▶ Select **Settings > Tire Pressure Monitor** in the on-board computer.
The **Tire Pressure Monitor Use Current Pressures As New Reference Values?** message appears in the display.

- ▶ Select **Yes** and press **OK** to confirm. The display shows the **Tire Pressure Monitor Restarted** message.
- ▶ Press **OK** to confirm.

If the **Tire Pressure Monitor Restarted** message does not appear after 5 seconds, repeat the tire pressure monitor restart.

Checking the tire pressures

Please note

WARNING

Underinflated or overinflated tires pose the following risks:

- the tires may burst, especially as the load and vehicle speed increase.
- the tires may wear excessively and/or unevenly, which may greatly impair tire traction.
- the driving characteristics, as well as steering and braking, may be greatly impaired.

There is a risk of an accident.

Follow recommended tire inflation pressures and check the pressure of all the tires including the spare wheel:

- monthly, at least
- if the load changes
- before beginning a long journey
- under different operating conditions, e.g. off-road driving

If necessary, correct the tire pressure.

WARNING

If you mount unsuitable accessories onto tire valves, the tire valves may be overloaded and malfunction, which can cause tire pressure loss. Due to their design, retrofitted tire pressure monitoring systems will keep the tire valve open. This can also result in tire pressure loss. There is a risk of an accident.

Only screw standard valve caps or valve caps specifically approved for your vehicle by smart onto the tire valve.

⚠ WARNING

If the tire pressure drops repeatedly, the wheel, valve or tire may be damaged. Tire pressure that is too low may result in a tire blow-out. There is a risk of an accident.

- Check the tire for foreign objects.
- Check whether the wheel is losing air or the valve is leaking.

If you are unable to rectify the damage, contact a qualified specialist workshop.

The recommended tire pressures for the tires mounted at the factory can be found on the labels described here.

Further information is available in qualified specialist workshops.

The specifications on the sample Tire and Loading Information placard and tire pressure tables are examples. Tire pressure specifications are vehicle-specific and may deviate from the data shown here. The valid tire pressure value can be found on the Tire and Loading Information placard and the vehicle's tire pressure table.

TIRE	MAX. LOAD (kg)	MAX. TIRE PRESSURE (kPa)	SEE OWNER'S MANUAL FOR ADDITIONAL INFORMATION
FRONT			
REAR			
SPARE			

① Recommended tire pressures

The Tire and Loading Information placard is on the door pillar on the driver's side (B-pillar).

The Tire and Loading Information placard contains the recommended tire pressures for cold tires. The recommended tire pressures are valid for the maximum permissible load and up to the maximum permissible vehicle speed.

The tire pressure table is on the inside of the socket flap.

	FRONT	REAR
normal load	2.30 bar	2.30 bar
maximum load	2.50 bar	2.50 bar

Warm tires up to: + 4 psi

Example: tire pressure table for all tires permitted for this vehicle by the factory

The tire pressure table contains the recommended pressures for cold tires for various operating conditions, i.e. differing load and speed conditions.

LUFTDRUCK	PRESSURE	PRESSION	PRESSION
for full load	for cold tires	des pneus froids	de fríos
195/55 R16	2.30	2.30	2.30
215/45 R17	2.50	2.50	2.50
215/40 R18	2.50	2.50	2.50

Warm tires up to: + 30 kPa / + 4 psi

Example: tire pressure table with tire dimensions

If a tire size precedes a tire pressure, the tire pressure information following is only valid for that tire size. The load conditions "partially laden" and "fully laden" are defined in the table for different numbers of occupants and amounts of luggage. The actual number of seats may differ.

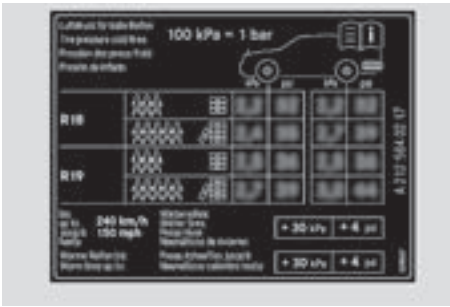

Some tire pressure tables only show the rim diameter instead of the complete tire size, e.g. R18. The rim diameter is part of the tire size and can be found on the tire sidewall.

If the tire pressures have been set to the lower values for lighter loads and/or lower speeds, correct them in the following cases:

- If you are driving with a heavier load
 - If you are driving at higher speeds
- i** The tire pressure recommended for increased loads and higher speeds in the tire pressure table can affect driving comfort.

If the tire pressure is not set correctly, this can lead to an excessive build up of heat and a sudden loss of pressure.

Underinflated or overinflated tires

⚠ WARNING

Tires with pressure that is too low can overheat and burst as a consequence. In addition, they also suffer from excessive and/or irregular wear, which can severely impair the braking properties and the driving characteristics. There is a risk of an accident.

Avoid tire pressures that are too low in all the tires, including the spare wheel.

⚠ WARNING

Tires with excessively high pressure can burst because they are damaged more easily by road debris, potholes etc. In addition, they also suffer from irregular wear, which can severely impair the braking

properties and the driving characteristics. There is a risk of an accident.

Avoid tire pressures that are too high in all the tires, including the spare wheel.

Possible consequences of underinflated tires:

- Tire defects as a result of overheating
- Adverse effect on handling characteristics
- Quick and uneven wear
- Adverse effect on energy consumption

Possible consequences of overinflated tires:

- Longer braking distance
- Adverse effect on handling characteristics
- Quick and uneven wear
- Adverse effect on driving comfort
- Increased susceptibility to damage

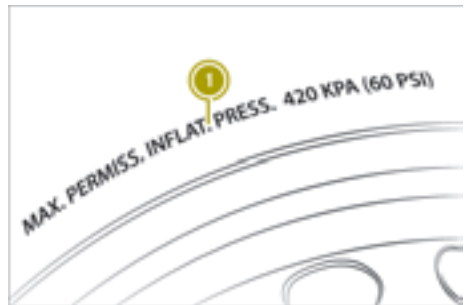

i Example: maximum permissible tire pressure

Do not exceed the maximum permissible tire inflation pressure. Always observe the recommended tire pressure when adjusting the tire pressure.

The actual values for tires are vehicle-specific and may deviate from the values in the illustration.

Checking and correcting the tire pressure manually

Observe the notes on tire pressure.

Only check the tire pressure once the tires have cooled down.

- ▶ Drive the vehicle less than 1 mile (1.6 km).
- ▶ Park the vehicle away from direct sunlight for at least three hours.

- ▶ Remove the valve cap of the tire being checked.
- ▶ Press the tire pressure gauge securely onto the valve.
- ▶ Read the tire pressure and compare it with the recommended value on the Tire and Loading Information placard.
- ▶ If the tire pressure is too low, increase the tire pressure to the recommended value.
- ▶ If the tire pressure is too high, release air. To do this, press down the metal pin in the valve using the tip of a pen, for example. Then, check the tire pressure again using the tire pressure gauge.
- ▶ Screw the valve cap onto the valve.
- ▶ Repeat these steps for the other tires.

Using winter tires

WARNING

M+S tires with a tire tread depth of less than $\frac{1}{8}$ in (4 mm) are not suitable for use in winter and do not provide sufficient traction. There is a risk of an accident.

M+S tires with a tread depth of less than $\frac{1}{8}$ in (4 mm) must be replaced immediately.

At temperatures below 45 °F (+7 °C), summer tires lose elasticity and therefore traction and braking power. Change the tires on your vehicle therefore to winter tires or all-season tires marked with M+S. Using summer tires at very cold temperatures could cause tears to form, thereby damaging the tires permanently. smart cannot accept responsibility for this type of damage.

Have the vehicle winterproofed at a qualified specialist workshop at the onset of winter.

- ▶ At low temperatures, use only winter tires marked with M+S.
- ▶ Use M+S tires with the additional  snowflake symbol in wintry road conditions. These tires allow driving safety systems, e.g. ABS, to function optimally in winter.
- ▶ Use M+S tires of the same make and tread on all wheels.
- ▶ When driving with M+S tires, observe the specified maximum permissible speed.

- ▶ Use only tire types and sizes approved for smart.
- ▶ When using tires with a specified direction of rotation, observe the arrow on the sidewall indicating the tire's direction of rotation.

After mounting M+S tires:

- ▶ Check the tire pressure.
- ▶ Restart the tire pressure monitor.

Using snow chains

WARNING

If snow chains are installed to the front wheels, they may drag against the vehicle body or chassis components. This could cause damage to the vehicle or the tires. There is a risk of an accident.

To avoid hazardous situations:

- never install snow chains to the front wheels
- always install snow chains in pairs to the rear wheels.

! **Vehicles with steel wheels:** if you mount snow chains on steel wheels, you may damage the hub caps. Remove the hub caps from the relevant wheels before mounting the snow chains.

For safety reasons, smart recommends that you only use snow chains that have been specially approved for your vehicle by smart. Further information can be obtained at a smart center or a qualified specialist workshop.

Note that snow chains are always designed for a specific tire size. If you mount tires that are larger or smaller than the original tires, you will require new snow chains of the correct size.

- ▶ Observe country-specific regulations.
- ▶ Use only snow chains approved for smart.
- ▶ Mount snow chains on both rear wheels.

- ▶ Use snow chains only on snow-covered roads.
- ▶ When driving with snow chains mounted, do not exceed the maximum permissible speed of 30 mph (50 km/h).

Changing the window wiper blades

Please note

WARNING

If the windshield wipers begin to move while you are changing the wiper blades, you could be trapped by the wiper arm. There is a risk of injury.

Always switch off the windshield wipers and ignition before changing the wiper blades.

- ❗ Never open the service cover or tailgate if a wiper arm has been folded away from the windshield or rear window. Never fold a wiper arm without a wiper blade back onto the windshield or rear window. Hold the windshield wiper arm firmly when you change the wiper blade. If you release the wiper arm without a wiper blade and it falls onto the window, the window may be damaged by the force of the impact.

window wiper blades can be removed from the wiper arm.

- ▶ Slide window wiper blade ① in the direction of arrow ⑤ until the securing hook for the window wiper blade is revealed.
- ▶ Remove the window wiper blade.

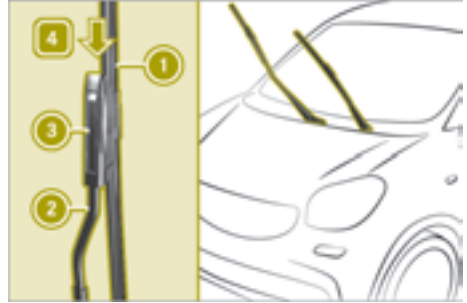

- ▶ Slide new window wiper blade ① in the direction of arrow ④ onto mounting ③ of wiper arm ②. The window wiper blade snaps into place.
- ▶ Check that the window wiper blade is positioned correctly.
- ▶ Carefully fold wiper arm ② onto the windshield.

Changing the rear window wiper blade (smart fortwo coupe)



- ▶ Remove SmartKey from ignition lock.
- ▶ Fold wiper arm ① away from the rear window until you hear it engage.
- ▶ Unscrew window wiper blade ② in the direction of the arrow until it is released from the retainer on the wiper arm.
- ▶ Pull out window wiper blade ②.

Changing the window wiper blades on the windshield

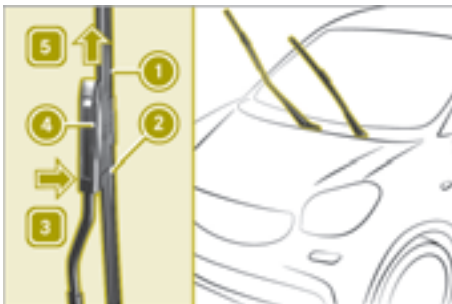

- ▶ Fold the wiper arm away from the windshield.
- ▶ Press release clips ② on mounting ④ in the direction of windshield ③. The catch tab is released from the mounting and the

- ▶ Press new window wiper blade ② onto wiper arm ① until it engages.
- ▶ Check that window wiper blade ② is positioned correctly.
- ▶ Fold wiper arm ① back onto the rear window.

Cleaning the vehicle

Useful information

Regular care maintains the appearance and quality of the vehicle over time.

Observe the following when cleaning and caring for the vehicle:

- ▶ Do not clean the engine.
- ▶ Do not clean the vehicle whilst charging.
- ▶ Use soft, moist cloths.
- ▶ Use care products and cleaning agents recommended and approved by smart.
- ▶ Do not use acidic cleaning agents.
- ▶ In winter, carefully remove road salt as soon as possible.

Cleaning the vehicle exterior

Cleaning the vehicle

Preparing the vehicle for cleaning

WARNING

Braking efficiency is reduced after washing the vehicle. There is a risk of an accident.

After the vehicle has been washed, brake carefully while paying attention to the traffic conditions until full braking power is restored.

- ▶ Close the side windows completely.
- ▶ Switch off the climate control blower.
- ▶ Turn the windshield wiper to position 0.

Cleaning in an automatic car wash

- ❗ Never clean your vehicle in a Touchless Automatic Car Wash as these use special cleaning agents. These cleaning agents can damage the paintwork or plastic parts.

- ▶ Prepare the vehicle for cleaning.
- ▶ Remove excess dirt.
- ▶ Drive through the automatic car wash.
- ▶ Remove wax from the front windshield and the wiper blades.

- i If the windshield wipers leave smears after the vehicle has passed through the car wash, this may be caused by wax or other residue. This residue can be removed with washer fluid.

Washing by hand

- ▶ Locate a washing bay equipped for hand-washing.
- ▶ Prepare the vehicle for cleaning.
- ▶ Apply mild cleaning agent with a soft vehicle sponge.
- ▶ Thoroughly hose the vehicle with a gentle jet of water; do not point the water jet directly towards the air inlet grille.
- ▶ Dry the vehicle off with a chamois.

Cleaning with a power washer

WARNING

The water jet from a circular jet nozzle (dirt blasters) can cause invisible exterior damage to the tires or chassis components. Components damaged in this way may fail unexpectedly. There is a risk of an accident.

Do not use power washers with circular jet nozzles to clean the vehicle. Have damaged tires or chassis components replaced immediately.

- ❗ Always maintain a distance of at least 11.8 in (30 cm) between the vehicle and the power washer nozzle. Information about the correct distance is available from the equipment manufacturer.

Move the power washer nozzle around when cleaning your vehicle.

Do not aim directly at any of the following:

- Tires
- Door gaps, roof gaps, joints, etc.
- Electrical components
- Battery
- Connectors

- Lamps
- Seals
- Trim
- Ventilation slots

Damaged seals or electrical components can lead to leaks or failures.

- ▶ Prepare the vehicle for cleaning.
- ▶ Maintain a distance of at least 11.8 in (30 cm) between the power washer nozzle and the vehicle.
- ▶ Keep moving the nozzle whilst cleaning.

Cleaning the sensors

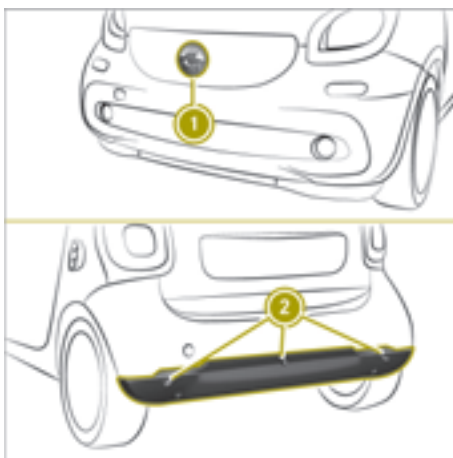

- ① Forward collision warning sensor
- ② Parking aid sensors

- ▶ Clean sensors with water, car shampoo and a soft cloth.

Cleaning the wheels

⚠ WARNING

The water jet from a circular jet nozzle (dirt blasters) can cause invisible exterior damage to the tires or chassis components. Components damaged in this way may fail unexpectedly. There is a risk of an accident.

Do not use power washers with circular jet nozzles to clean the vehicle. Have damaged tires or chassis components replaced immediately.

- ❗ Do not use acidic wheel cleaning products to remove brake dust. This could damage wheel bolts and brake components.

- ❗ Do not park your vehicle for a long period of time directly after cleaning, particularly after cleaning the wheel rim with wheel cleaner. Wheel cleaner can lead to the increased corrosion of the brake discs and pads. Therefore, drive for a few minutes after cleaning. By heating up the brakes, the brake discs and pads dry. The vehicle can then be parked for a long period of time.

- ▶ Clean the wheels with an acid-free cleaning agent.

Cleaning the windows and windshield wiper

Cleaning the windows

⚠ WARNING

You could become trapped by the windshield wipers if they start moving while cleaning the windshield or wiper blades. There is a risk of injury.

Always switch off the windshield wipers and the ignition before cleaning the windshield or wiper blades.

- ▶ Place the wiper arms in the vertical position and fold them away from the window.
- ▶ Clean the inside and outside of the windows with a damp cloth and a cleaning agent recommended by smart.
- ▶ Clear deposits regularly from the windshield and rear window to ensure that water can drain unhindered.

Cleaning the window wiper blades

- ▶ Place the wiper arms in the vertical position and fold them away from the window.
- ▶ Clean the window wiper blades with a soft cloth.
- ▶ Fold the wiper arms back into place.

Cleaning the panoramic roof (smart fortwo coupe)

- ❗ Only use cleaning agents or cleaning cloths which are suitable for plastic light

lenses. Unsuitable cleaning agents or cleaning cloths could scratch or damage the plastic windows of the panoramic roof. Do not use cleaning agents which contain solvents.

- ▶ Apply mild cleaning agent for plastic lenses and wipe off with a moist sponge.

Cleaning the roof

Dry cleaning

- ▶ Brush from the front to the back using a soft brush.

Wet cleaning

- ▶ Dry clean first.
- ▶ Wash down with a soft brush or sponge and lukewarm water.
- ▶ Rinse with clean water.

Cleaning the soft top (smart fortwo cabrio)

Useful information

! Never use a power washer to clean the soft top, otherwise water could enter the vehicle interior.

! Only clean the folding top and rear soft top when they are closed.

Dry cleaning

- ▶ Brush from the front to the back using a soft brush.

Wet cleaning

- ▶ Dry clean first.
- ▶ Wash down with a soft brush or sponge and lukewarm water.
- ▶ Rinse with clean water.

Cleaning the exterior lighting

- ▶ Apply mild cleaning agent for plastic lenses and wipe off with a wet sponge.

Cleaning and caring for paintwork

! Do not attach stickers to the paint surface. The adhesive residues may damage the paintwork.

- ▶ Remove impurities immediately by rubbing carefully.
- ▶ Soak insect remains with insect remover and rinse off.
- ▶ Soak bird droppings with water and rinse off.
- ▶ Use tar remover to remove tar stains.
- ▶ Use silicone remover to remove wax.
- ▶ Remove coolant, brake fluid, tree resin, oils, fuels and greases by rubbing carefully with a cloth soaked in petroleum ether or lighter fluid.
- ▶ Use a suitable touch-up stick, e.g. MB Touch-Up Stick, to repair slight damage to the paintwork quickly and provisionally.

When water no longer forms beads on the paint surface, use the care product Paint Care, which has been approved by smart. This is the case approximately every three to five months, depending on the climate conditions and the care product used.

If any dirt has penetrated the paint surface or the paint has become dull, the paintwork should be cleaned. Use the care product Paint Care recommended and approved by smart to clean the paintwork.

Do not use these care products in the sun or on the hood while the hood is hot.

Cleaning the vehicle interior

Cleaning the displays

! For cleaning, do not use any of the following:

- alcohol-based thinner or gasoline
- abrasive cleaning agents
- commercially-available household cleaning agents

These may damage the display surface. Do not put pressure on the display surface when cleaning. This could lead to irreparable damage to the display.

- ▶ Switch off the display and let it cool down.
- ▶ Clean the display surface with a microfiber cloth and cleaner for TFT/LC displays.
- ▶ Dry the display surface using a dry microfiber cloth.

Cleaning the steering wheel and the gear lever

- ▶ Wipe off with a moist cloth, or use a leather care agent recommended by smart.

Cleaning the seat belts

WARNING

Seat belts can become severely weakened if bleached or dyed. This could cause the seat belts to tear or fail, for instance, in the event of an accident. This poses an increased risk of injury or fatal injury.

Never bleach or dye the seat belts.

- ❗ Do not clean the seat belts using chemical cleaning agents. Do not dry the seat belts by heating at temperatures above 176 °F (80 °C) or in direct sunlight.
- ▶ Clean the seat belts using only lukewarm soapy water.

Cleaning and caring for seats

Please note

- ❗ Do not use microfiber cloths to clean genuine leather or artificial leather covers, as these are too aggressive and, if used often, may damage the cover.

Regular care maintains the appearance and feel of the seats over time.

Cleaning and caring for genuine leather seat covers

- ▶ Wet a cloth with water and clean the seat covers. Do not allow the leather to become soaked.
- ▶ Wipe off with a dry cloth.
- ▶ Apply a leather care agent recommended by smart.

Cleaning synthetic leather seat covers

- ▶ Wet a cloth with detergent water and clean the seat covers.

Cleaning cloth seat covers

- ▶ Wet a microfiber cloth with detergent water.
- ▶ Rub cloth covers with care, cleaning entire sections of the cover.
- ▶ Allow the seat to dry.

Cleaning DINAMICA seat covers

- ▶ Wet a cloth with water.
- ▶ Clean entire sections of the cover.

Cleaning the paneling

Cleaning the plastic trim

WARNING

Care products and cleaning agents containing solvents cause surfaces in the cockpit to become porous. As a result, plastic parts may come loose in the event of air bag deployment. There is a risk of injury.

Do not use any care products and cleaning agents to clean the cockpit.

- ❗ Never attach the following to plastic surfaces:

- stickers
- films
- perfume oil container or similar

You could otherwise damage the plastic.

To maintain the appearance of high-quality plastic surfaces, do not allow surfaces to come into contact with cosmetics, insect repellents or sun creams.

- ▶ Clean the plastic trim with a damp cloth.
- ▶ Use care products and cleaning agents recommended by smart to remove heavy soiling.

Cleaning the headliner (smart fortwo coupe)

- ▶ Remove heavy soiling using a soft brush or a cleaning agent recommended by smart.



Cleaning the carpets



- ▶ Use carpet and textile cleaning agents recommended by smart.

Cleaning the trim elements

- ❗ Do not use solvent-based cleaning agents such as tar remover, wheel cleaners, polishes or waxes. There is otherwise a risk of damaging the surface.
- ▶ Clean the trim elements with a moist microfiber cloth.
- ▶ Use care products and cleaning agents recommended by smart to remove heavy soiling.

Observing service due dates

The  and  indicator lamps in the instrument cluster display are reminders of upcoming service due dates:

- : minor service.
- : major service.

The service interval is based on normal operation of the vehicle. Observe the following if the vehicle is operated under arduous conditions or increased loads, e.g. regular city driving with frequent intermediate stops:

- ▶ Carry out service work more often than specified by the service interval.
- ▶ Check the tires more frequently.

Current information on the type of service can be obtained at a smart Center or a qualified specialist workshop.

Parking the vehicle for a long period

- ❗ Please note that if the vehicle is not used for prolonged periods, vehicle damage may occur and the battery may discharge or become damaged.
- ▶ Visit a qualified specialist workshop and seek advice.

Securing the vehicle in the event of an accident or a breakdown

Securing the vehicle

- ❗ When a tire is damaged, the danger area must be kept clear of all persons.
- ▶ Stop the vehicle away from traffic on solid, non-slippery ground.
- ▶ Switch on the hazard warning lights.
- ▶ Turn the front wheels to the straight-ahead position.
- ▶ Switch off the engine.
- ▶ Passengers should leave the vehicle.
- ▶ Secure the vehicle against rolling away.

In the case of a flat tire, without TIREFIT the vehicle cannot be made roadworthy again using the on-board equipment. No emergency call can be made via the smart Audio-System. The vehicle owner and the driver of the vehicle are responsible for equipping the vehicle with an appropriate breakdown kit and seeking assistance in the event of a breakdown.

Switching the hazard warning lamps on and off

When the hazard warning lamps are switched on, all the turn signal lamps flash. The hazard warning lamps automatically switch on in the following cases:

- an air bag is deployed.
- the vehicle decelerates rapidly from a speed of more than 45 mph (70 km/h) and comes to a standstill.

The hazard warning lamps switch off automatically if the vehicle reaches a speed of above 6 mph (10 km/h) again after a full brake application.

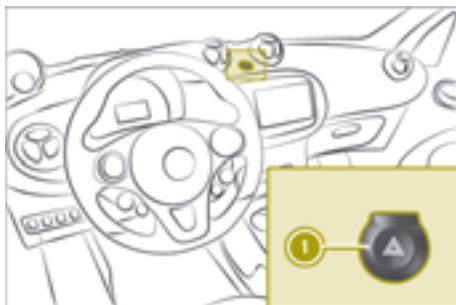

- ▶ To switch on the hazard warning lamps manually: press button ①.

Securing the vehicle to prevent it from rolling away

Securing on level ground



- ▶ To change the wheel, place chocks or other suitable items under the front and rear of the wheel that is diagonally opposite the wheel you wish to change.

Securing on a downhill gradient

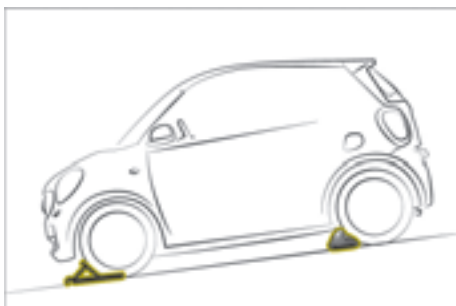

- ▶ Place wheel chocks or other suitable items in front of the wheels of the front and rear axle.

Removing the vehicle tool tray



The towing eye and the TIREFIT kit are located in the vehicle tool tray under the glove box.

- ▶ Remove bolts in the front-passenger footwell.
- ▶ Remove the vehicle tool tray.

Sealing tires using the TIREFIT kit

Useful information

The tire sealant is pumped into the tire.

TIREFIT is a tire sealant. TIREFIT is used to seal punctures of up to 0.16 in (4 mm), particularly those in the tire tread, at outside temperatures of up to -4 °F (-20 °C).

Please note

⚠ WARNING

In the following situations, the tire sealant is unable to provide sufficient breakdown assistance, as it is unable to seal the tire properly:

- there are cuts or punctures in the tire larger than those mentioned above.
- the wheel rim is damaged.
- you have driven at very low tire pressures or on a flat tire.

There is a risk of an accident.

Do not drive the vehicle. Contact a qualified specialist workshop.

⚠ WARNING

The tire sealant is harmful and causes irritation. It must not come into contact with your skin, eyes or clothing or be swallowed. Do not inhale TIREFIT fumes. Keep tire sealant away from children. There is a risk of injury.

If you come into contact with the tire sealant, observe the following:

- Rinse off the tire sealant from your skin immediately with water.
- If the tire sealant comes into contact with your eyes, immediately rinse them thoroughly with clean water.
- If tire sealant is swallowed, immediately rinse your mouth out thoroughly and drink plenty of water. Do not induce vomiting, and seek medical attention immediately.
- Immediately change out of clothing which has come into contact with tire sealant.
- If an allergic reaction occurs, seek medical attention immediately.

⚠ WARNING

A tire temporarily sealed with tire sealant impairs the driving characteristics and is not suitable for higher speeds. There is a risk of accident.

You should therefore adapt your driving style accordingly and drive carefully. Do not exceed the specified maximum speed with a tire that has been repaired using tire sealant.

The maximum permissible speed for a tire sealed with tire sealant is 50 mph (80 km/h).

- ❗ After use, excess tire sealant may run out of the filler hose. This could cause stains. Therefore, place the filler hose in the plastic bag that contained the TIREFIT kit.

Environmental note

Have the used tire sealant bottle disposed of professionally, e.g. at a qualified specialist workshop.

Comply with the manufacturer's safety instructions on the sticker on the tire inflation compressor.

Filling with tire sealant

- ▶ Leave foreign bodies which have penetrated the tire in the tire.
- ▶ Remove the vehicle tool tray.
- ▶ Remove the TIREFIT Kit, consisting of a tire sealant bottle and a tire inflation compressor, from the vehicle tool kit.
- ▶ Affix the 50 mph (80 km/h) maximum speed sticker to the instrument cluster within the driver's field of vision.

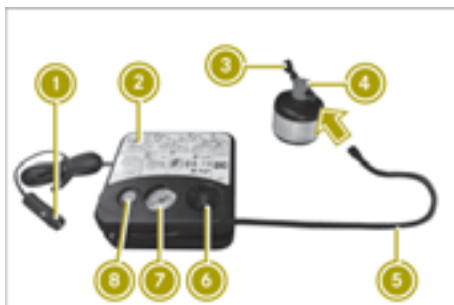

- ▶ Unwind plug ① with the cable from tire inflation compressor ②.
- ▶ Remove hose ⑤ from the bottom section of tire inflation compressor ②.
- ▶ Unscrew the cap from tire sealant bottle ④.
- ▶ Connect hose ⑤.

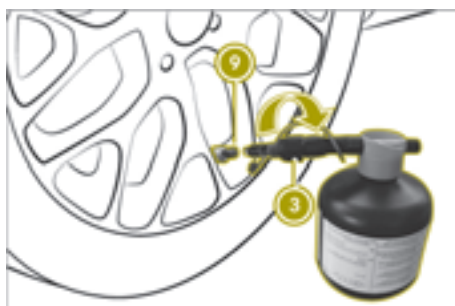

- ▶ Remove valve flap from valve ⑨ on the defective tire.
- ▶ Unscrew cap from filler hose ③.
- ▶ Screw filler hose ③ onto valve ⑨.
- ▶ Insert connector ① into the 12 V socket.
- ▶ Turn the SmartKey to position ① in the ignition lock.
- ▶ Press on/off switch ⑥ on tire inflation compressor ② to position 1. The tire sealant is pumped into the tire. The pressure in pressure gauge ⑦ may briefly rise to approximately 600 kPa (6.0 bar/86 psi).

i Preventing damage to the tire inflation compressor

Do not switch off the tire inflation compressor during this phase.

- ▶ Let the tire inflation compressor run for a maximum of 15 minutes, then allow it to cool down.

The tire pressure in pressure gauge ⑦ must be at least 180 kPa (1.8 bar/26 psi).

Allow any leaked tire sealant to dry. It can then be removed like a layer of film.

Have any clothing stained with tire sealant cleaned as soon as possible with perchloroethylene.

Further procedure if the pressure of the sealed tire is below 180 kPa

⚠ WARNING

If the specified tire pressure is not reached, the tire is too severely damaged. The tire sealant cannot offer assistance with a flat tire in this case. Damaged tires as well as tire pressure that is too low can

impair the braking and driving characteristics. There is a risk of an accident.

Do not drive any further. Notify a qualified specialist workshop.

- ▶ Switch off the tire inflation compressor.
- ▶ Unscrew the filler hose from the valve of the defective tire.
Please note that tire sealant may escape when unscrewing.
- ▶ Slowly move the vehicle approximately 30 ft (10 m) forward or back.
- ▶ Pump up the tire again.
After a maximum of 15 minutes, the tire pressure must be at least 180 kPa (1.8 bar/26 psi).

Further procedure if the pressure of the sealed tire is at least 180 kPa

- ▶ Switch off the tire inflation compressor.
- ▶ Unscrew the hose from the valve of the defective tire.
Please note that tire sealant may escape when unscrewing.
- ▶ Stow the tire sealant bottle and the tire inflation compressor.
- ▶ Perform a test drive.
The maximum permissible speed for a tire sealed with tire sealant is 50 mph (80 km/h).
- ▶ Stop driving after approximately 2 miles (3 km) and check the tire pressure with the tire inflation compressor.
The tire pressure must now be at least 130 kPa (1.3 bar/19 psi). The precise values are located on the door pillar (B-pillar) on the driver's side.
- ▶ If necessary, adjust the tire pressure.
- ▶ Unscrew the filler hose from the valve on the sealed tire.
Please note that tire sealant may escape when unscrewing.
- ▶ Screw the valve cap onto the valve of the sealed tire.
- ▶ Pull the tire sealant bottle out of the tire inflation compressor. The filler hose stays on the tire sealant bottle.

- ▶ Drive to the nearest qualified specialist workshop and have the tire changed there.
- ▶ Have the tire sealant bottle and filler hose replaced as soon as possible at a qualified specialist workshop.

Adjusting the tire pressure

Increasing the tire pressure

- ▶ Switch on the tire inflation compressor.
- ▶ Observe the display.

Reducing the tire pressure



- ▶ Press button ① next to pressure gauge ②.
- ⓘ Even unused tire sealant loses its effectiveness over time.
Have the tire sealant bottle replaced every four years at a qualified specialist workshop.

Towing the vehicle

Please note

WARNING

Functions relevant to safety are restricted or no longer available if:

- the ignition is switched off
- the brake system or the power steering is malfunctioning
- there is a malfunction in the power supply or the vehicle's electrical system

If your vehicle is being towed, much more force may be necessary to steer or brake. There is a risk of an accident.

In such cases, use a tow bar. Before towing, make sure that the steering moves freely.

WARNING

You can no longer steer the vehicle if the steering wheel lock has been engaged. There is a risk of an accident.

Always switch off the ignition when towing the vehicle with a tow cable or a tow bar.

WARNING

When towing or tow-starting another vehicle and its weight is greater than the permissible gross weight of your vehicle, the:

- the towing eye could detach itself
- the vehicle/trailer combination could rollover.

There is a risk of an accident.

When towing or tow-starting another vehicle, its weight should not be greater than the permissible gross weight of your vehicle.

Information on the vehicle's permissible gross mass can be found on the vehicle identification plate (▷ page 180).

! Observe the following points when towing with a tow rope:

- Secure the tow rope on the same side on both vehicles.
- Ensure that the tow cable is not longer than legally permitted. Mark the tow cable in the middle, e.g. with a white cloth (30 x 30 cm). This will make other road users aware that the vehicle is being towed.
- Only secure the tow cable to the towing eye.
- Observe the brake lamps of the towing vehicle while driving. Always maintain

a distance so that the tow rope does not sag.

- Do not use steel cables or chains to tow your vehicle. You could otherwise damage the vehicle.

! Do not use the towing eyes for recovery purposes as this could damage the vehicle. If in doubt, recover the vehicle with a crane.



! When towing, pull away slowly and smoothly. If the tractive power is too high, the vehicles could be damaged.

! Do not tow with sling-type equipment. This could damage the vehicle.

! The vehicle can be towed a maximum of 30 miles (50km). The towing speed of 30 mph (50 km/h) must not be exceeded. If the vehicle has to be towed more than 30 miles (50km), the entire vehicle must be raised and transported.

Observe the legal requirements for the relevant countries when towing.

Always have the vehicle transported in the following cases:

- The  warning lamp lights up and **Do Not Tow Vehicle with Wheels on Ground** appears in the display of the instrument cluster.
- The multifunction display is not working.
- One of more of the following warning lamps is lit up:
 -  drive diagnostics (red)
 -  12 V battery
- The brake pedal begins to pulsate as the towing procedure commences.
- The vehicle must be moved over a long distance.

The transmission must be in position **N** when the vehicle is being towed.

i Before the vehicle is towed, switch off the automatic locking feature. The driver could otherwise be locked out when pushing or towing the vehicle.

i **Vehicles with the basic carrier installed:**

Do not tow the vehicle with the basic carrier installed.

Do not secure the tow rope or tow bar to the basic carrier.

Observe the notes on the selector lever when towing the vehicle.

- ▶ Release the parking brake.
- ▶ Switch on the hazard warning lights.

Installing the towing eye

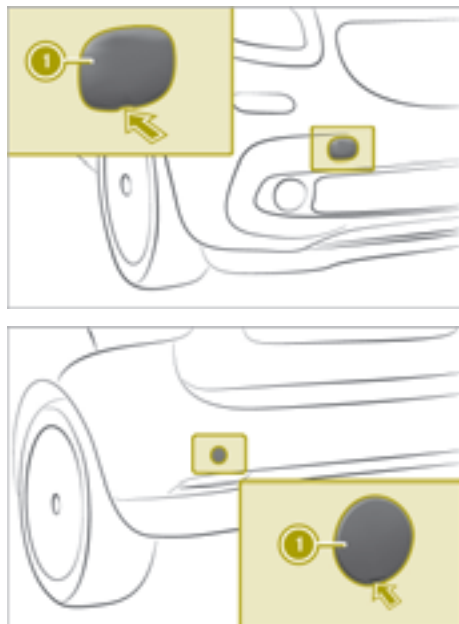

The towing eye can be attached to the front or rear of the vehicle.

- ▶ Remove the towing eye from the vehicle tool tray.
- ▶ Carefully lever off cover ① on the vehicle.
- ▶ Screw in the towing eye to the stop.

Towing a vehicle with both axles on the ground

- ▶ Turn the SmartKey to position 2 in the ignition lock.
- ▶ Depress the brake pedal and keep it depressed.
- ▶ Shift the automatic transmission to position N.

The selector lever lock can be manually released in the event of an electrical malfunction.

- ▶ Release the brake pedal.

Transporting the vehicle

❗ Only secure the vehicle by the wheels or rims, not by parts of the vehicle such as the axle or steering components. Otherwise the vehicle could be damaged.

- ▶ Turn the SmartKey to position 2 in the ignition lock. Shift the transmission to position N.

As soon as the vehicle has been loaded:

- ▶ Apply the parking brake.
- ▶ Shift the transmission to position P.
- ▶ Remove the SmartKey.
- ▶ Lash down the vehicle.

Removing the towing eye

- ▶ Loosen the towing eye and unscrew it.
- ▶ Attach the cover to the recess at the top and engage it at the bottom.
- ▶ Stow the towing eye in the vehicle tool tray.

Manually releasing the selector lever lock

The selector lever lock can be manually released in the event of an electrical malfunction, e.g. if the parking lock has been deactivated for towing and should subsequently be re-applied.

❗ Do not use any sharp-edged objects to pry out the cover from the center console. Otherwise, the cover or the center console could be damaged.

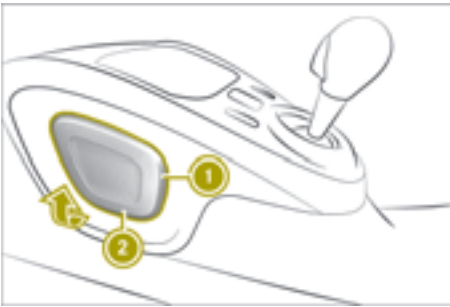

- ▶ Apply the parking brake.
- ▶ Open the drawer on the front-passenger side.
- ▶ Lever off cover ① on the center console from bottom edge ② using a flat, blunt object.
- ▶ Pull cover ① in the direction of the arrow.

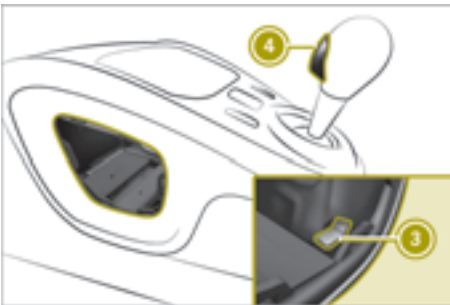

- ▶ Pull yellow release ③ behind the trim up and simultaneously press release button ④ on the selector lever.
- ▶ Shift the selector lever to N or P.

Replacing the bulbs

Useful information

⚠ WARNING

Bulbs, lamps and connectors can get very hot when operating. If you change a bulb, you could burn yourself on these components. There is a risk of injury.

Allow these components to cool down before changing a bulb.

Observe the following rules when changing bulbs:

- only replace bulbs when the engine is switched off.
- do not use bulbs that have been dropped or show signs of visible damage, e.g. scratches.
- do not touch the glass bulb with your bare hands.
- only use bulbs in enclosed lamps designed for that purpose.
- only install spare bulbs of the same type and with a specified voltage.
- do not allow bulbs to come into contact with moisture.
- have LEDs changed at qualified specialist workshops only.

Change only the bulbs described below yourself in accordance with the specified bulb types.

Replacing front bulbs

Replacing low-beam headlamps and high-beam headlamps

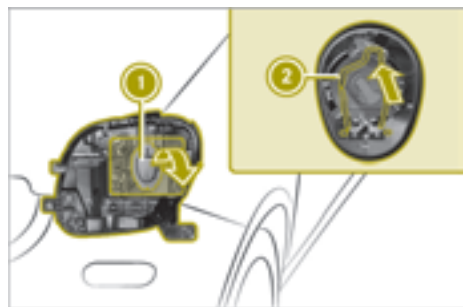

- ▶ Switch off lights.
- ▶ Open the service cover.
- ▶ Remove cover ①.
- ▶ Pull out the connector.
- ▶ Press retainer ② inwards and to the left.
- ▶ Pull the bulb out.
- ▶ Insert the new bulb.
- ▶ Lock retainer ②.
- ▶ Insert the connector.
- ▶ Replace and engage cap ①.

Replacing the front turn signal lamps



- ▶ Switch off lights.
- ▶ Turn the respective front wheel inward.
- ▶ Push clamp ① down.
- ▶ Remove cover ② up.
- ▶ Turn the bulb holder counter-clockwise and remove it.
- ▶ Remove the bulb from the bulb holder.
- ▶ Insert the new bulb.
- ▶ Insert the bulb holder and turn it clockwise until it engages.
- ▶ Insert and engage cover ②.

Replacing the side turn signal lamps



- ▶ Carefully insert a flat tool into recess ①.
- ▶ Lever off side turn signal ②.
- ▶ Unscrew the bulb from the bulb holder.
- ▶ Insert the new bulb into the bulb holder.
- ▶ Re-install side turn signal ②.

Replacing rear bulbs

Changing the tail lamp bulbs

Tail lamps without partial LEDs

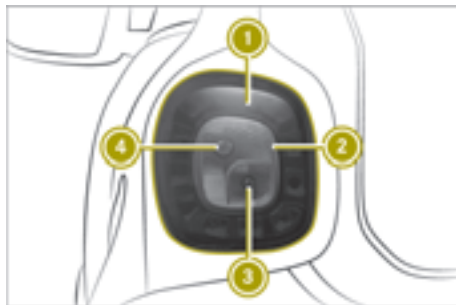

- ① Rear lamp, brake lamp and side marker lamp
- ② Rear fog lamp
- ③ Reversing lamp
- ④ Turn signals

Tail lamps with partial LEDs



- ① Turn signals
- ② Reversing lamp

Removing the tail lamp cover

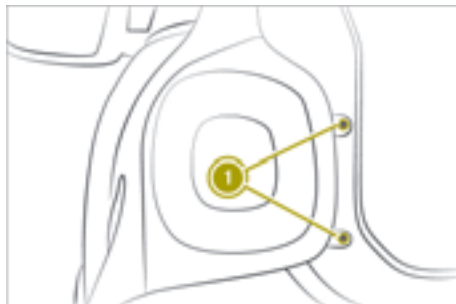

- ▶ Switch off lights.
- ▶ **smart fortwo coupe:** open the upper and lower tailgate.
- ▶ **smart fortwo cabrio:** open the lower tailgate.
- ▶ **smart fortwo cabrio:** fold the rear soft top up.
- ▶ Loosen screws ①.
- ▶ Remove the tail lamp.
- ▶ Carefully insert a flat tool under the plastic hanger on the tail lamp.
- ▶ Lift the connector and remove it.

Replacing a defective tail lamp bulb

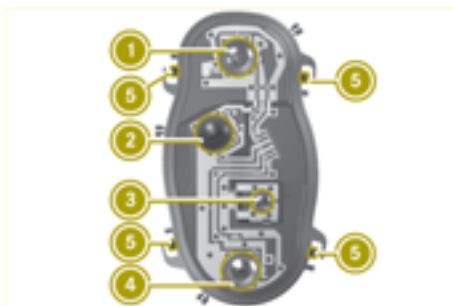

- ① Rear lamp, brake lamp and side marker lamp (vehicles without partial LEDs)
- ② Turn signals
- ③ Reversing lamp
- ④ Rear fog lamp (vehicles without partial LEDs)
- ▶ Release four tabs ⑤ on the bulb holder.
- ▶ Remove the bulb holder.
- ▶ Pull the defective bulb out.
- ▶ Insert the new bulb.
- ▶ Re-install the bulb holder.
- ▶ Insert the connector.
- ▶ Insert the tail lamp until you hear it engage.
- ▶ Tighten the screws on the tail lamp.

Replacing the license plate lamp

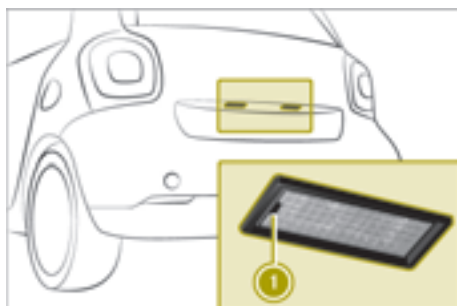

- ▶ Insert a flat tool into recess ①.
- ▶ Remove the cover from the license plate lamp.
- ▶ Remove the bulb from the holder.
- ▶ Insert the new bulb into the holder.
- ▶ Insert the lamp lens into the license plate lamp.

Replacing the interior lighting



- ▶ Insert a flat tool into the recess.
- ▶ Lever off lamp lens ①.
- ▶ Remove the bulb from the holder.
- ▶ Insert the new bulb into the holder.
- ▶ Re-install the lamp lens.

Changing fuses

Please note

⚠ WARNING

If you manipulate or bridge a faulty fuse or if you replace it with a fuse with a higher

amperage, the electric cables could be overloaded. This could result in a fire. There is a risk of an accident and injury. Always replace faulty fuses with the specified new fuses having the correct amperage.

! Only use fuses that have been approved for smart vehicles and which have the correct fuse rating for the system concerned. Otherwise, components or systems could be damaged.

! Make sure that no moisture can enter the fuse box when the cover is open.

The electrical fuses disconnect defective circuits. If a fuse blows, all the connected components and their functions will fail.

Blown fuses must be replaced with fuses of the same rating, which you can recognize by the color and value. The fuse ratings are listed in the fuse allocation chart (▷ page 183). If new fuses blow, the cause for this must be diagnosed and rectified at a qualified specialist workshop.

Certain vehicle functions are protected via the fuse box in the front area. Access to the fuses is very restricted. Have a blown fuse in the front area replaced at a qualified specialist workshop.

Preparing the vehicle to change a fuse

- ▶ Apply the parking brake.
- ▶ Switch off all electrical consumers.
- ▶ Turn the SmartKey to position **0** in the ignition lock and remove it.
- ▶ Check whether all indicator lamps in the instrument cluster are off.

Changing a fuse (left-hand drive vehicle)

! Do not use a pointed object such as a screwdriver to open the cover in the dashboard. You could damage the dashboard or the cover.

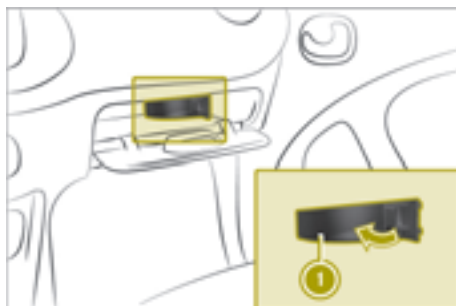

- ▶ Open the front-passenger door.
- ▶ Open the glove box.
- ▶ To open: open cover ① in the direction of the arrow.
- ▶ Replace the defective fuse.
- ▶ To close: insert and fold in cover ① until it engages.
- ▶ Close the glove box.

Replacing the SmartKey battery

! WARNING

Batteries contain toxic and corrosive substances. If batteries are swallowed, it can result in severe health problems. There is a risk of fatal injury.

Keep batteries out of the reach of children. If a battery is swallowed, seek medical attention immediately.



- ▶ Insert a flat tool, e.g. a coin, into the recess.
- ▶ Turn the tool until the cover of the battery tray opens.

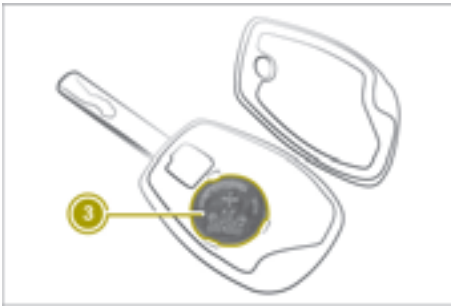

The SmartKey batteries contain perchlorate material, which may require special handling and regard for the environment. National guidelines must be observed during disposal. In California, www.dtsc.ca.gov/HazardousWaste/Perchlorate/index.cfm.

Opening a door with the emergency release



If the vehicle cannot be opened using the remote control key, the vehicle can be opened using the emergency release.

If the driver's door is unlocked and opened with the SmartKey in the emergency release, the anti-theft alarm system will issue an alarm. To disable the alarm, switch on the ignition.

- ▶ Carefully remove the cover from the emergency release.
- ▶ Insert the SmartKey into the emergency release on the driver's door.
- ▶ Turn the SmartKey counter-clockwise.
- ▶ Remove the SmartKey from the lock.
- ▶ Push the cover into the emergency release until it engages.

- ▶ Open the door.
- ▶ To disable the alarm from the anti-theft alarm system: switch on the ignition.

Locking the doors in an emergency

Locking the doors with the locking button



- ▶ Remove the SmartKey from the ignition lock.
- ▶ Open the driver's door.
- ▶ Close the other doors and the tailgate.
- ▶ Press and hold button ①. An audible locking and unlocking sound can be heard. Wait until the third (locking) sound, before releasing button ①.
- ▶ Leave the vehicle and close the driver's door.
The doors, tailgate and socket cap are locked. The anti-theft alarm system is armed.
- ▶ From the outside, check that the doors, tailgate and socket cap are locked.

>> Dealing with accidents and breakdowns.

Locking the doors with the emergency locking

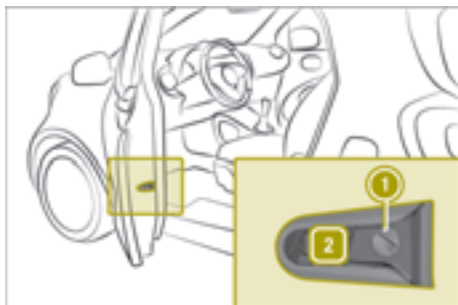

- ▶ Insert the SmartKey into slot ① on the left door.
 - ▶ Turn the SmartKey towards the hood as far as it will go to position ②.
 - ▶ Close the left door.
 - ▶ Repeat the procedure described above on the right door.
 - ▶ Check that the doors are locked.
- i** If you lock the vehicle using the emergency locking, the tailgate and fuel filler flap are not locked. The anti-theft alarm system is not armed.

Notes on display messages



The display shows warnings, malfunctions or additional information. A warning tone also sounds with some display messages. Messages from all categories can contain important information that must be observed. Have malfunction messages checked at an authorized Mercedes-Benz Center as soon as possible. If an error message is not followed up with a repair, this can lead to damage that is not covered by the Mercedes-Benz Limited Warranty including injuries or material damage.

Display messages with graphic symbols may be simplified in the Operator's Manual and may differ from the symbols shown in the display.



Low-priority display messages can be hidden by pressing **[OK]** on the steering wheel. High-priority messages are shown in red. The display messages are then stored in the message memory and can be called up for as long as the ignition remains switched on. Switching off the ignition clears the message memory.

Locking and unlocking





Problem	Possible causes/consequences and ► Solutions
SmartKey will not lock or unlock the vehicle.	A strong source of radio waves is interfering with the signal. ► Stand closer to the door lock and try to lock/unlock the vehicle again.
	SmartKey battery is low or discharged. ► Unlock the vehicle with the SmartKey in the emergency release or lock the vehicle with emergency locking. ► Replace the SmartKey battery.
	SmartKey is faulty. To lock: ► Press the locking button and close the door within five seconds. The vehicle still will not lock. ► Lock driver's door using emergency locking. ► Consult a qualified specialist workshop. To unlock: ► Unlock vehicle with the SmartKey in the emergency release. ► Consult a qualified specialist workshop.
SmartKey is lost.	► Have the SmartKey deactivated or replaced at a qualified specialist workshop. ► Report loss of the SmartKey to vehicle insurer.
Remove Key appears. Warning tone sounds.	The SmartKey is in the ignition lock. ► Remove the SmartKey.

Problem	Possible causes/consequences and ► Solutions
Warning tone sounds.	<p>Driver's door is opened while the engine is running. Switch off the engine before leaving the vehicle:</p> <ul style="list-style-type: none"> ► Apply the parking brake. ► Select transmission position P. ► Turn the SmartKey to position 0 in the ignition lock and remove it.
Side window will not close or will not open or close fully.	<p>Objects are obstructing the window guide.</p> <ul style="list-style-type: none"> ► Remove objects. <p>Side window is not reset.</p> <p> WARNING</p> <p>While closing the side windows, body parts in the closing area could become trapped. There is a risk of injury.</p> <p>When closing make sure that no parts of the body are in the closing area. If somebody becomes trapped, release the switch or press the switch to open the side window again.</p> <ul style="list-style-type: none"> ► Close all the doors. ► Turn the SmartKey to position 2 in the ignition lock. ► Pull the switch for closing the window until the window is closed, and then push the switch for one second. <p>The side window opens again a little way.</p> <ul style="list-style-type: none"> ► Repeat previous step until the window remains closed after releasing the switch.
<p> Red warning lamp is lit.</p> <p>If the speed exceeds 12 mph (20 km/h), a warning tone also sounds.</p> <p>The display shows an open door/tailgate.</p>	<p>Door or tailgate is open.</p> <ul style="list-style-type: none"> ► Pull over and stop the vehicle, paying attention to road and traffic conditions. ► Close all doors and the tailgate.







Visibility, occupants, air bags

Problem	Possible causes/consequences and ► Solutions
Exterior mirror is not engaged.	The exterior mirror has been moved forward or back by force. ► Carefully move exterior mirror to the correct position.
Windshield wiper is malfunctioning.	Windshield wiper is obstructed, e.g. by snow. ► Pull over and stop the vehicle, paying attention to road and traffic conditions. ► Remove SmartKey from ignition lock. ► Remove the cause of the obstruction. ► Switch the windshield wipers on again after 30 seconds. Windshield wiper drive is malfunctioning. ► Select another wiper speed on the combination switch. ► Consult a qualified specialist workshop.
Windshield wiper will not stop or always wipes at the same speed.	Combination switch or rain sensor is malfunctioning. ► Pull over and stop the vehicle, paying attention to road and traffic conditions. ► Remove SmartKey from ignition lock. ► Insert the SmartKey into the ignition lock, turn it to position 1 and start the engine. ► Consult a qualified specialist workshop.
 Red warning lamp lights up for 6 seconds after starting the engine. Warning tone sounds.	Warning lamp prompts driver and front passenger to fasten their seat belts. ► Fasten seat belts.
 Red warning lamp lights up after starting the engine.	Driver or front passenger has not fastened their seat belt. ► Fasten seat belts.
 Red warning lamp flashes. Warning tone sounds.	The driver or front passenger has not fastened their seat belt and the vehicle is traveling faster than 12 mph (20 km/h). ► Fasten seat belts.









>> Practical advice.





Problem	Possible causes/consequences and ► Solutions
 Red warning lamp lights up while the engine is running. Malfunction Visit Workshop appears.	Restraint system is malfunctioning.  WARNING If the restraint system is malfunctioning, restraint system components may be triggered unintentionally or may not deploy as intended during an accident. This can affect for example the Emergency Tensioning Device or the air bag. This poses an increased risk of injury or even fatal injury. Have the restraint system checked and repaired in a qualified specialist workshop as soon as possible.
 Indicator lamp on the overhead control panel lights up.	The front-passenger air bag has been deactivated (▷ page 39). ► Activate front-passenger air bag. Front-passenger air bag has not been deactivated and is malfunctioning. ► Do not use a rearward-facing child restraint system on front-passenger seat. ► Do not allow passengers to travel on the front-passenger seat. ► Consult a qualified specialist workshop.
 Indicator lamp on the overhead control panel lights up.	The front-passenger air bag is enabled (▷ page 39). The air bag system is operating correctly. ► Do not use a rearward-facing child restraint system on front-passenger seat.
 Indicator lamp on the overhead control panel does not light up if the front-passenger air bag has been activated manually.	Malfunction in the air bag system. ► Do not allow passengers to travel on the front-passenger seat. ► Consult a qualified specialist workshop.

Engine, brakes, transmission



Problem	Possible causes/consequences and ► Solutions
Engine will not start using the SmartKey.	Steering lock is manually locked. <ul style="list-style-type: none"> ► Remove SmartKey from ignition lock and then reinsert it into the ignition lock. ► Turn the SmartKey. ► Turn steering wheel left and right.
 Red warning lamp lights up. Warning tone sounds. Without Starting Motor Again, Visit Workshop appears.	Serious malfunction in the high-voltage electrical system. The engine can no longer be started. <ul style="list-style-type: none"> ► Do not restart the engine. ► Consult a qualified specialist workshop.
 Red warning lamp lights up. Stop Switch Off Motor appears.	High-voltage electrical system, engine or high-voltage battery is malfunctioning. <ul style="list-style-type: none"> ► Switch off the engine. ► Do not drive on. ► Consult a qualified specialist workshop. ► Do not tow away the vehicle on its own wheels.
 Red warning lamp lights up. Warning tone sounds. Stop appears.	Communication with the engine's control unit is disrupted. <ul style="list-style-type: none"> ► Switch off the engine. ► Do not drive on. ► Consult a qualified specialist workshop. ► Do not tow away the vehicle on its own wheels.
 Yellow warning lamp lights up. Warning tone sounds. Malfunction Visit Workshop appears.	Malfunction in the high-voltage electrical system. The vehicle's high-voltage electrical system may become damaged if you continue running the engine. <ul style="list-style-type: none"> ► Switch off the engine. ► Do not drive on. ► Consult a qualified specialist workshop. ► Do not tow away the vehicle on its own wheels.
 Red warning lamp lights up. Warning tone sounds. Reduce Speed appears.	Speed of the vehicle is above 84 mph (135 km/h). <ul style="list-style-type: none"> ► Reduce speed to below 84 mph (135 km/h).
 lights up. Do Not Tow Vehicle With Wheels on Ground appears.	Drive system or high-voltage electrical system is faulty. <ul style="list-style-type: none"> ► Have the vehicle transported by a qualified specialist workshop. ► Do not tow away the vehicle on its own wheels.



>> Practical advice.



Problem	Possible causes/consequences and ► Solutions
<p> (USA only) or  (Canada only) Red warning lamp lights up while the engine is running.</p> <p>Warning tone sounds.</p> <p>Check Brake Fluid Level appears.</p>	<p>Brake fluid level is too low.</p> <p> WARNING</p> <p>If the brake fluid level is too low, the brake system may fail. There is a risk of an accident.</p> <p>Stop the vehicle immediately, paying attention to road and traffic conditions. Secure the vehicle using the parking brake. Do not drive any further. Consult a qualified specialist workshop immediately and have the brake system repaired.</p> <p>Do not add brake fluid. This does not correct the malfunction.</p> <p>► Consult a qualified specialist workshop.</p>
<p> (USA only) or  (Canada only) Red warning lamp lights up while driving.</p> <p>Warning tone sounds.</p> <p>Release Parking Brake appears.</p>	<p>Parking brake is applied.</p> <p>► Release the parking brake.</p>
<p> (USA only) or  (Canada only) Red warning lamp lights up while the engine is running.</p> <p>Warning tone sounds.</p> <p>Brake System Malfunction Stop appears.</p>	<p>Serious malfunction in the brake system.</p> <p>► Consult a qualified specialist workshop.</p>
<p> Yellow warning lamp lights up.</p> <p>Malfunction Visit Workshop appears.</p>	<p>Malfunction in the vacuum supply of the brake system.</p> <p>► Consult a qualified specialist workshop.</p>

Problem	Possible causes/consequences and ► Solutions
<p>Transmission Not in P Risk of Vehicle Rolling Away appears. Warning tone sounds.</p>	<p>The driver's door is open and the selector lever is in position R, N or D.</p> <p> WARNING</p> <p>The vehicle may roll away. There is a risk of an accident.</p> <ul style="list-style-type: none"> ► Select position P. ► Switch off the engine. ► Close the driver's door completely.
<p> or  warning lamp flashes for a few seconds after starting the engine. Next service due in ... km or Service due ... km ago appears.</p>	<p>A service due date is approaching or has already passed:</p> <ul style="list-style-type: none"> •  indicates a minor service. •  indicates a full service. <p>► Consult a qualified specialist workshop.</p>







Charging process





Problem	Possible causes/consequences and ► Solutions
The charge socket flap cannot be opened.	<p>The charge socket flap is not unlocked.</p> <ul style="list-style-type: none"> ► Press the  button on the SmartKey.
	<p>The SmartKey batteries are discharged.</p> <ul style="list-style-type: none"> ► Opening a door with the emergency release
The charging cable cannot be plugged into the vehicle socket.	<p>The vehicle socket is locked.</p> <ul style="list-style-type: none"> ► Make sure that the gear lever is in position P.
 on the vehicle socket flashes red. The high-voltage battery is not being charged.	<p>A malfunction occurred while initializing the charging process.</p> <ul style="list-style-type: none"> ► Make sure that the charging cable is plugged into the mains socket. ► Disconnect the charging cable connector from the vehicle socket and plug it back into the vehicle socket after 30 seconds. ► If the malfunction should persist, inform a qualified specialist workshop.



Problem	Possible causes/consequences and ► Solutions
 on the vehicle socket remains off after the charging cable connector has been connected to the vehicle socket. When charging using a mains socket, the high-voltage battery is not charged.	<p>There is a malfunction at the mains socket.</p> <ul style="list-style-type: none"> ► Have the mains socket checked to ensure that it is working correctly. <p>or</p> <ul style="list-style-type: none"> ► Use a different mains socket.
 lights up. Warning tone sounds. Charger Cable Connected appears.	<p>The charging cable is plugged into the vehicle socket. The engine cannot be started.</p> <ul style="list-style-type: none"> ► Before driving off, disconnect the charging cable from the vehicle socket and stow it in the vehicle.
 flashes. Charging Cable Not Inserted Correctly appears.	<p>The charge cable is connected to the vehicle socket. The battery is not being charged.</p> <ul style="list-style-type: none"> ► Make sure that the charge cable is correctly plugged into the sockets on the vehicle and power connection. If necessary, disconnect the charge cable from the sockets and then reconnect it. <p>If the message continues to be displayed:</p> <ul style="list-style-type: none"> ► Consult a qualified specialist workshop.
Charging Not Possible Power Supply Interrupted appears.	<p>The high-voltage battery cannot be charged. The charge current was interrupted during the charging process.</p> <ul style="list-style-type: none"> ► Make sure that the charging cable is plugged into the mains socket. ► Disconnect the charging cable connector from the vehicle socket and plug it back into the vehicle socket after 30 seconds. <p>If the message continues to be displayed:</p> <ul style="list-style-type: none"> ► Consult a qualified specialist workshop.
Charging Not Possible See Operator's Manual appears.	<p>Communication with the charging point infrastructure is not functioning correctly.</p> <ul style="list-style-type: none"> ► Make sure that the charge cable is correctly plugged into the sockets on the vehicle and power connection. If necessary, disconnect the charge cable from the sockets and then reconnect it. <p>If the message continues to be displayed:</p> <ul style="list-style-type: none"> ► Use a different charging station. <p>If the message continues to be displayed:</p> <ul style="list-style-type: none"> ► Consult a qualified specialist workshop.





Problem	Possible causes/consequences and ► Solutions
 Yellow warning lamp lights up. Charging Not Possible Visit Workshop appears.	<p>The vehicle electronics are malfunctioning. The high-voltage battery cannot be charged.</p> <ul style="list-style-type: none"> ► Consult a qualified specialist workshop.
 Yellow warning lamp lights up. Charging Not Possible See. Operator's Manual appears.	<p>The high-voltage battery cannot be charged. The charging cable connector is overheated.</p> <ul style="list-style-type: none"> ► Remove the charging cable connector from the vehicle socket. ► Allow the charging cable connector to cool off for several minutes. ► Plug the charging cable back into the vehicle socket. <p>If the message continues to be displayed:</p> <ul style="list-style-type: none"> ► Consult a qualified specialist workshop.









Driving safety systems

Problem	Possible causes/consequences and ► Solutions
<p>  (USA only) or  (Canada only) Yellow warning lamp lights up. System Inoperative appears. </p>	<p> ABS is malfunctioning. Other driving systems may be deactivated. If ABS is faulty, there is also a possibility that other driving systems may be unavailable. Observe the information on the ABS warning lamp and display messages which may be shown in the instrument cluster. </p> <p>  WARNING </p> <p> If ABS is faulty, the wheels could lock when braking. The steerability and braking characteristics may be severely impaired. Additionally, further driving safety systems are deactivated. There is an increased danger of skidding and accidents. Drive on carefully. Have ABS checked immediately at a qualified specialist workshop. </p> <ul style="list-style-type: none"> ► Pull over and stop the vehicle, paying attention to road and traffic conditions. ► Secure the vehicle against rolling away. ► Consult a qualified specialist workshop.
<p>  (USA only) or  (Canada only) Red warning lamp lights up while the engine is running. Warning tone sounds. Brake Force Distribution Inoperative Stop See Operator's Manual appears. </p>	<p> EBD is malfunctioning. This means that ABS, ESP®, Crosswind Assist and Hill start assist are also unavailable. Other driving systems may be deactivated. </p> <p>  WARNING </p> <p> The brake system continues to function normally, but without the functions listed above. The wheels could therefore lock early if you brake hard, for example. The steerability and braking characteristics may be severely affected. The braking distance may increase in emergency braking situations. If ESP® is not operational, ESP® is unable to stabilize the vehicle. There is an increased risk of skidding and an accident. </p> <ul style="list-style-type: none"> ► Pull over and stop the vehicle, paying attention to road and traffic conditions. ► Secure the vehicle against rolling away. ► Consult a qualified specialist workshop.





Problem	Possible causes/consequences and ► Solutions
 Yellow warning lamp lights up. System Inoperative appears.	<p>ESP® is not available due to a malfunction. Other driving systems may be deactivated.</p> <p> WARNING</p> <p>If ESP® is malfunctioning, ESP® is unable to stabilize the vehicle. Additionally, further driving safety systems are deactivated. This increases the risk of skidding and an accident.</p> <p>Drive on carefully. Have ESP® checked at a qualified specialist workshop.</p> <p>Brake lamps may be inoperative and thus no longer working when braking.</p> <ul style="list-style-type: none"> ► Pull over and stop the vehicle, paying attention to road and traffic conditions. Do not drive on. ► Check that the brake lamps are working. <p>The brake lamps are not working.</p> <ul style="list-style-type: none"> ► Consult a qualified specialist workshop. <p>Brake lamps are working.</p> <ul style="list-style-type: none"> ► Drive on carefully. ► Consult a qualified specialist workshop.
 Yellow warning lamp flashes while driving.	<p>ESP® is intervening because there is a risk of skidding or at least one of the wheels is spinning.</p> <ul style="list-style-type: none"> ► Pull away carefully. ► Accelerate carefully whilst driving. ► Adapt your driving style to suit the road and weather conditions.
 and  and other warning lamps are lit. Electronics Mal-function Visit Workshop appears.	<p>Central vehicle electronics system is malfunctioning.</p> <p>After switching off the engine, it is no longer possible to lock or unlock the doors using the remote control on the SmartKey or to start the engine.</p> <ul style="list-style-type: none"> ► Pull over and stop the vehicle, paying attention to road and traffic conditions. ► Consult a qualified specialist workshop.





Problem	Possible causes/consequences and ► Solutions
 Hill Start Assist Inoperative appears.	<p>Hill start assist is malfunctioning. Vehicle will not be held automatically when pulling away uphill and may start rolling immediately.</p> <p> WARNING</p> <p>If ESP® is malfunctioning, ESP® is unable to stabilize the vehicle. Additionally, further driving safety systems are deactivated. This increases the risk of skidding and an accident.</p> <p>Drive on carefully. Have ESP® checked at a qualified specialist workshop.</p> <p>Other driving systems may be deactivated.</p> <p>The brake system functions normally, but without hill start assist.</p> <ul style="list-style-type: none"> ► Drive on carefully. ► Consult a qualified specialist workshop.
 Yellow warning lamp lights up while driving. Correct Tire Pressure appears.	<p>The tire pressure is too low in at least one of the tires, or the tire pressure difference between the wheels is too great.</p> <ul style="list-style-type: none"> ► Check the tire pressure. ► Correct the tire pressure. ► Restart the tire pressure monitor.

Problem	Possible causes/consequences and ► Solutions
<p> Yellow warning lamp lights up while driving.</p> <p>Tire Pressure Warning Tire Failure appears.</p>	<p>The tire pressure monitor has detected a significant loss of pressure in at least one of the tires.</p> <p> WARNING</p> <p>Underinflated or overinflated tires pose the following risks:</p> <ul style="list-style-type: none"> • the tires may burst, especially as the load and vehicle speed increase. • the tires may wear excessively and/or unevenly, which may greatly impair tire traction. • the driving characteristics, as well as steering and braking, may be greatly impaired. <p>There is a risk of an accident.</p> <p>Observe the recommended tire pressure and check the tire pressure of all the tires:</p> <ul style="list-style-type: none"> • at least every two weeks • if the load changes • before beginning a long journey • for changed operating conditions, e.g. off-road driving <p>If necessary, correct the tire pressure.</p> <ul style="list-style-type: none"> ► Secure the vehicle against rolling away. ► Check the tires visually and, if necessary, follow the instructions for flat tires. ► Check the tire pressure and correct it if necessary.
<p> Yellow warning lamp flashes for approximately one minute and then stays lit.</p> <p>Tire Pressure Monitor Inoperative appears.</p>	<p>The tire pressure monitor is malfunctioning or was not restarted after a wheel change.</p> <p> WARNING</p> <p>If you correct the tire pressure without recalibrating the Run Flat Indicator, the system cannot issue a warning about a defective tire in time. In the event of tire pressure loss, the driving characteristics and the steering and braking may be greatly impaired. There is a risk of an accident.</p> <p>If you correct the tire pressure, you must recalibrate the Run Flat Indicator.</p> <ul style="list-style-type: none"> ► Restart the tire pressure monitor. <p>The display message continues to be displayed.</p> <ul style="list-style-type: none"> ► Drive on carefully. ► Consult a qualified specialist workshop.





Problem	Possible causes/consequences and ► Solutions
<p> Yellow warning lamp flashes for approximately 60 seconds and then remains lit.</p> <p>Tire Pressure Monitor Inoperative Wheel Sensors Missing appears.</p>	<p>There is no signal from the tire pressure sensor of one or more wheels.</p> <p> WARNING</p> <p>Risk of accident due to undetected tire pressure losses. The system is possibly unable to recognize or register low tire pressure.</p> <p>► Consult a qualified specialist workshop.</p> <hr/> <p>Wheels have unsuitable tire pressure sensors.</p> <p>► Mount wheels with suitable tire pressure sensors.</p>
<p> (USA only) or  (Canada only) Red warning lamp lights up.</p> <p>,  Yellow warning lamps light up while the engine is running.</p> <p>Warning tone sounds.</p> <p>Electronics Malfunction Stop See Operator's Manual appears.</p>	<p>The following systems are malfunctioning:</p> <ul style="list-style-type: none"> • ABS (Anti-lock Braking System) • ESP® (Electronic Stability Program) • Crosswind Assist • Hill start assist <p>Other driving systems could be switched off automatically.</p> <p> WARNING</p> <p>The risk of skidding and having an accident increases due to malfunctioning driving safety systems.</p> <p>The brake system functions normally, but without the systems listed. The wheels could therefore lock if you brake hard, for example.</p> <p>This will greatly impair the ability to steer and brake. The braking distance may increase in emergency braking situations.</p> <p>► Pull over and stop the vehicle, paying attention to road and traffic conditions.</p> <p>► Consult a qualified specialist workshop.</p>
<p> Yellow warning lamp lights up while the engine is running.</p> <p>Power Steering Malfunction See Operator's Manual</p> <p>or</p> <p>Electronics Malfunction See Operator's Manual appears.</p>	<p>Power assistance may be malfunctioning, making steering difficult.</p> <p> WARNING</p> <p>You will need to use more force to steer.</p> <p>There is a risk of an accident.</p> <p>► Check whether you are able to apply the extra force required.</p> <p>If you are able to steer safely:</p> <ul style="list-style-type: none"> ► Drive on carefully. ► Visit a qualified specialist workshop immediately. <p>If you are unable to steer safely:</p> <ul style="list-style-type: none"> ► Do not drive on. ► Consult a qualified specialist workshop.



Driver assistance systems

Problem	Possible causes/consequences and ► Solutions
 Red warning lamp is lit. Warning tone sounds.	Forward collision warning detects an obstacle on the road. ► Pay careful attention to the road and traffic conditions and be ready to brake.
 Yellow warning lamp lights up while driving. Distance Warning Inoperative or Electronics Malfunction Visit Workshop appears.	The sensors in the radiator trim are dirty. ► Clean the sensors. Environmental influences or error sources outside the system are temporarily interfering with the forward collision warning. Possible causes are: <ul style="list-style-type: none"> • heavy rain or snow • operating temperature is too high • on-board voltage is too low Forward collision warning is operational again when the causes listed no longer apply. Warning lamp remains lit. ► Pull over and stop the vehicle, paying attention to road and traffic conditions. ► Clean the sensors. ► Restart the engine. Warning lamp still remains lit. ► Consult a qualified specialist workshop.
 and  and other warning lamps are lit.	Central vehicle electronics system is malfunctioning. After switching off the engine, it is no longer possible to lock or unlock the doors using the remote control on the SmartKey or to start the engine. ► Pull over and stop the vehicle, paying attention to road and traffic conditions. ► Consult a qualified specialist workshop.

Problem	Possible causes/consequences and ► Solutions
 flashes for approximately 10 seconds. Warning tone sounds.  Cruise Control Inoperative appears.	Cruise control is malfunctioning and deactivates automatically. ► Consult a qualified specialist workshop.
 flashes for approximately 10 seconds.  and other warning lamps are also lit. Warning tone sounds. Electronics Malfunction Visit Workshop appears.	Central vehicle electronics system and cruise control are malfunctioning. After switching off the engine, it is no longer possible to lock or unlock the doors using the remote control on the SmartKey or to start the engine. ► Pull over and stop the vehicle immediately, paying attention to road and traffic conditions. ► Consult a qualified specialist workshop.

Battery, lights, heating

Problem	Possible causes/consequences and ► Solutions
The rear window defroster or seat heating switches off automatically or cannot be switched on.	Battery is not sufficiently charged. ► Switch off electrical consumers that are not required.
 Display flashes. Heating HV Battery to Operating Temperature Please Wait... appears.	The high-voltage battery is brought up to operating temperature. This process may take several minutes. ► Wait until the  display goes out and then restart.
 Yellow warning lamp lights up. Battery Reserve Level appears.	The condition of charge of the high-voltage battery has dropped into the reserve range. ► Charge the high-voltage battery.
 Red warning lamp lights up when the vehicle is ready to start. Warning tone sounds. Stop See Operator's Manual appears.	12 V battery is not charged. ► Do not drive on. ► Pull over and stop the vehicle, paying attention to road and traffic conditions. ► Switch off the engine. ► Consult a qualified specialist workshop.
 Warning lamp lights up. Malfunction Visit Workshop appears.	Battery monitoring is malfunctioning. ► Consult a qualified specialist workshop.

Problem	Possible causes/consequences and ► Solutions
 Warning lamp lights up. Malfunction See Operator's Manual appears.	Low beam is on continuously. High beam cannot be activated. <ul style="list-style-type: none"> ► Switch off the engine. ► Restart the engine. Warning lamp remains lit. Rain/light sensor is malfunctioning. <ul style="list-style-type: none"> ► Manually adjust exterior lighting. ► Manually adjust the windshield wipers. ► Consult a qualified specialist workshop.
 Warning lamp lights up. Brake Lamps Inoperative appears.	 WARNING Risk of accident due to faulty brake lamps. The brake lamps are faulty and no longer alert other road users when braking. <ul style="list-style-type: none"> ► Pull over and stop the vehicle, paying attention to road and traffic conditions. ► Consult a qualified specialist workshop.
Switch Off Lights appears. Warning tone sounds.	Lights are still switched on when you leave the vehicle. <ul style="list-style-type: none"> ► Turn control knob for the lights to AUTO or 0.

smart Audio-System and smart Media-System

Bluetooth® connection

Problem	Possible causes/consequences and ► Solutions
Bluetooth® connection cannot be established between the smart Audio-System or smart Media-System and mobile phone.	<ul style="list-style-type: none"> ► Ascertain whether the mobile phone is compatible with the system. Information about compatible mobile phones: www.smart.com/connect ► Check the security settings on your mobile phone. ► Check that the Bluetooth® function is enabled on the smart Audio-System or smart Media-system and on your mobile phone. ► Start the device search on the smart Audio-System or smart Media-System and on the mobile phone.

>> Practical advice.

The navigation system in the smart Media-System

Problem	Possible causes/consequences and ► Solutions
No map is displayed in the navigation system.	The SD card with the map data is missing or damaged. ► Check to see that the SD card is inserted.
Position of the vehicle in the navigation system does not match the vehicle's actual position. GPS symbol on the display is gray or yellow.	GPS reception is poor. ► Drive the vehicle to another position where GPS reception is better.
The road's course in the navigation system no longer coincides with the actual road.	The map data is out of date. ► Update the map data.
Navigation system does not display any traffic information.	Route guidance has not been started. ► Select a destination and start navigation.
	HD Traffic is not available or the subscription for HD Traffic has expired. ► Check whether HD Traffic is available for the country you are in or upgrade the subscription for HD Traffic.
There are no navigation messages during route guidance.	The road's course is not detected. The map data may be out of date. ► Check if route guidance has started. ► If not, select a destination and start navigation.
	Navigation messages are switched off. ► Switch on navigation messages.

Voice control system in the smart Media-System

Problem	Possible causes/consequences and ► Solutions
The voice control system does not understand voice commands.	Interval for entering voice commands has been exceeded. ► Press the  button on the multifunction steering wheel.
	Voice commands have not been given from the driver's seat. ► Issue voice commands from the driver's seat.
	Noise from the blower or wind noise are interfering with voice commands. ► Avoid interfering noises.

Problem	Possible causes/consequences and ► Solutions
	Voice commands have not been given clearly. ► Say voice commands clearly.
	Voice command is unknown. ► Say the command "Help". A list of possible voice commands appears.

Obtaining technical data

The data stated here specifically refers to a vehicle with standard equipment. Information on vehicle variants and equipment is available from any smart center.

Reading out vehicle data

Useful information

- The heights and lengths specified vary as a result of:
 - tires
 - load
 - condition of the suspension
 - optional equipment
- Optional equipment reduces the maximum payload.

Vehicle identification plate



① Vehicle identification plate position



USA

- ② Vehicle model
- ③ Paint code



Canada

- ② Vehicle identification number (VIN)
- ③ Paint code

i The data shown on the vehicle identification plate is used only as an example. This data is different for every vehicle and can deviate from the data shown here. The data applicable to the vehicle is found on the vehicle's identification plate.

Dimensions and weights

Missing technical data was not available at the time of publication.

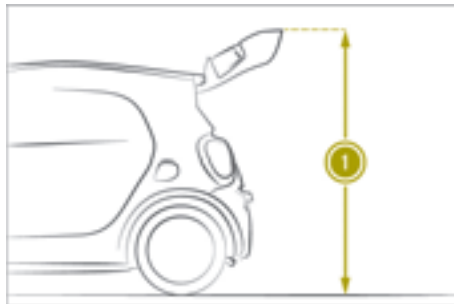

smart fortwo coupe electric drive	Dimensions and weights
Opening height ①	73.0 in (1855 mm)
Vehicle length	106.1 in (2695 mm)
Vehicle width including exterior mirrors	74.5 in (1893 mm)

smart fortwo coupe electric drive	Dimensions and weights
Vehicle width without exterior mirrors	65.4 in (1663 mm)
Vehicle height	61.2 in (1555 mm)
Wheelbase	73.7 in (1873 mm)
Maximum ground clearance	4.4 in (113 mm)
Maximum tailgate load	
Permissible roof load	0 lb (0 kg)

smart fortwo cabrio electric drive	Dimensions and weights
Height of open rear soft top	61.1 in (1553 mm)
Vehicle length	106.1 in (2695 mm)
Vehicle width including exterior mirrors	74.5 in (1893 mm)
Vehicle height	61.1 in (1553 mm)
Wheelbase	73.7 in (1873 mm)
Maximum ground clearance	4.3 in (110 mm)
Maximum tailgate load without side bars	
Maximum tailgate load with sidebars	
Permissible roof load	0 lb (0 kg)

Charging time

High-voltage battery

Model	Lithium-ion
Charging time (from 20 % to 100 %) at 32 A/240 V	Approx. 2 h 30 min
Charging time (from 20 % to 100 %) at 12 A/120 V	Approx. 13 h

Service products

Components and service products must be matched. Therefore, only use products tested and approved by Mercedes-Benz.

The following table lists all technical data for the service products of the vehicle. Further information on service products: <http://bevo.mercedes-benz.com> and in any smart center.

Service products	Specifications
Corrosion inhibitor/antifreeze (▷ page 126)	Recommended: G40
Windshield washer fluid (▷ page 127)	Temperatures above freezing point: mixing ratio of 1:100 MB SummerFit to water Temperatures below freezing point: for the correct mixing ratio of MB WinterFit and water, please observe the information on the antifreeze container.

Climate control system refrigerant

Important safety notes

Your vehicle's climate control system is filled with R-134a refrigerant.

The instruction label regarding the refrigerant type used can be found on the right hand side of the open service flap.

! Only the refrigerant R-134a and the PAG oil approved by Mercedes-Benz may be used. The approved PAG oil may not be mixed with any other PAG oil that is not approved for R-134a refrigerant. Otherwise, the climate control system may be damaged.

Service work, such as topping-up refrigerant or replacing components, may only be carried out at a qualified specialist workshop. All applicable regulations such as the SAE standard J639 must be adhered to.

Always have all work on the climate control system carried out at a qualified specialist workshop.

Refrigerant instruction label

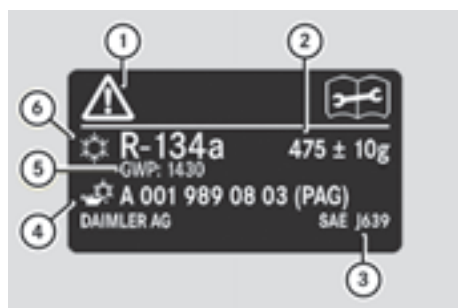

Example: refrigerant instruction label

- ① Warning symbols
- ② Refrigerant filling capacity
- ③ Applicable standards
- ④ PAG oil part number
- ⑤ GWP value
- ⑥ Refrigerant type

Warning symbols ① advise you about:

- possible dangers
- having service work carried out at a qualified specialist workshop

Filling capacities

Model	Refrigerant
All models	20.3 ± 0.4 oz (575 ± 10 g)

The GWP value of the refrigerant R-134a is 1430.

Bulb types

The following table lists the correct bulb types of the vehicle:

Bulb	Model
Low-beam/high-beam head-lamps	HB2
Front fog lamps	H 16
Turn signal	PY 21 W
Side turn signal lamps	WY 5 W
License plate lamp	W 5 W
Interior lighting	W 5 W

Tail lamp

Bulb	Model
Tail lamp, brake lamp and side marker lamp	P21 5 W
Rear fog lamp	P21 W
Backup lamp	W 16 W
Turn signal	PY 21 W

Fuse allocation

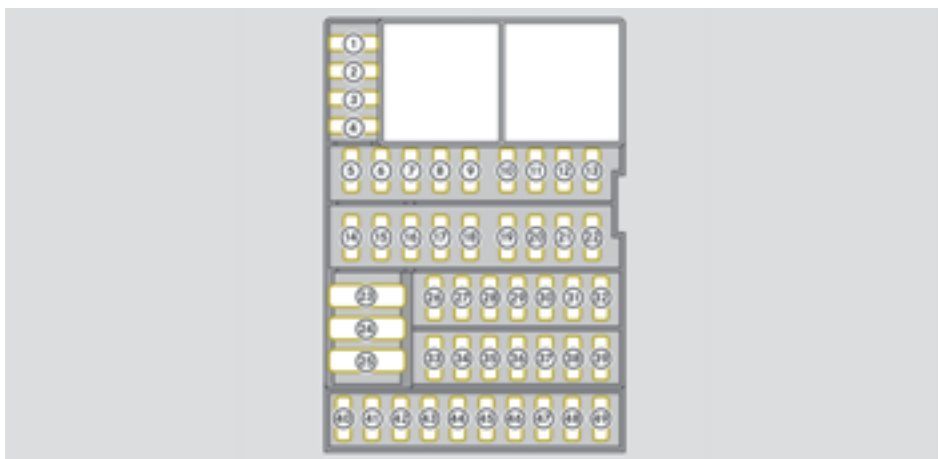

No.	Consumer	Current	Color coding
1	Starter motor	5 A	Brown
2	Power steering control unit	5 A	Brown
3	Multifunction lever	5 A	Brown
4	Air bag	5 A	Brown
5	Transmission control unit	25 A	Cyan
6	Instrument cluster	10 A	Red
7	Horn, alarm system	15 A	Blue
8	Power supply control unit	10 A	Red
9	Power supply control unit	10 A	Red
10	Central control unit	20 A	Yellow
11	Central control unit	15 A	Blue
12	Central control unit	10 A	Red
13	Central control unit	15 A	Blue
14	Power windows (automatic reversing feature)	30 A	Green
15	ESP®, transmission control unit	5 A	Brown
16	Interior lighting	10 A	Red
17	Immobilizer	3 A	Violet
18	Electrical exterior mirror	5 A	Brown
19	Brake lamps	10 A	Red

No.	Consumer	Current	Color coding
20	Cruise control, radio, belt warning	15 A	Blue
21	Not for smart electric drive: central control unit, fuel pump, injection	15 A	Blue
22	Rear window wiper	15 A	Blue
23	Only for smart electric drive: power supply control unit	40 A	Orange
24	-	-	-
25	Power supply control unit	30 A	Green
26	Radio	20 A	Yellow
27	Daytime running lamps	5 A	Brown
28	12 V socket, cigarette lighter	15 A	Blue
29	Power supply control unit	5 A	Brown
30	Forward collision warning	15 A	Blue
31	Rear fog lamp	-	-
32	Radio, central control unit	15 A	Blue
33	Tail lamps, front fog lamps, hazard warning lamp button, locking button, headlamp range control, power windows, license plate lamps, radio, control unit for air-conditioning system, cruise control, limiter, parking aid button, program selector button, tailgate release, Lane Keeping Assist camera, automatic start/stop system button	25 A	Cyan
34	Power supply control unit	25 A	Cyan
35	Headlamps, daytime running lamps	25 A	Cyan
36	Left-hand low beam, central control unit	10 A	Red
37	Right-hand low beam	10 A	Red
38	Left-hand low beam, central control unit	10 A	Red
39 - 42	-	-	-
43	Exterior mirror heating	5 A	Brown
44	Automatic reversing feature	25 A	Cyan
45	Power supply control unit	25 A	Cyan
46	Radio amplifier	20 A	Yellow
47 - 49	-	-	-

Radio type approvals for the tire pressure monitor

Country	Radio type approval number
USA	FCC ID: MRXMW2433A
	FCC ID: MRXGG4
	FCC ID: MRXMC34MA4
Canada	IC: 2546A-MW2433A
	IC: 2546A-GG4
	IC: 2546A-MC34MA4

Installing two-way radios and mobile phones (RF transmitters)

WARNING

The electromagnetic radiation from modified or incorrectly retrofitted RF-transmitters can interfere with the vehicle electronics. This can compromise the operational safety of the vehicle. There is a risk of an accident.

You should have all work to electrical and electronic equipment carried out at a qualified specialist workshop.

WARNING

The electromagnetic radiation from incorrectly operated RF transmitters can interfere with the vehicle electronics, for example:

- if the RF transmitter is not connected with an exterior antenna
- the exterior antenna has been installed incorrectly or is not a low-reflection type

This can compromise the operational safety of the vehicle. There is a risk of an accident.

Have the low-reflection exterior antenna mounted at a qualified specialist workshop. When operating RF transmitters in the vehicle, always connect them with the low-reflection exterior antenna.

 The operating permit may be invalidated if the instructions for installation and use of RF transmitters are not observed.

In particular, the following conditions must be complied with:

- only approved wavebands may be used.
- observe the maximum permissible output in these wavebands.
- only approved antenna positions may be used.

Excessive levels of electromagnetic radiation can cause damage to health. Using an exterior antenna takes into account current scientific discussions relating to the possible health hazards that may result from electromagnetic fields.

The following antenna positions may be used if RF transmitters have been properly installed:

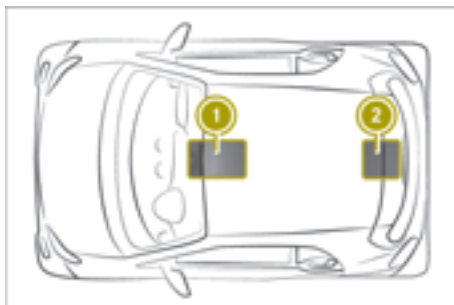

- ① Front roof area
- ② Rear roof area

Use Technical Specification ISO/TS 21609 (Road Vehicles – EMC guidelines for installation of aftermarket radio frequency transmitting equipment) when retrofitting RF (radio frequency) transmitters. Comply with the legal requirements for add-on parts.

If your vehicle has installations for two-way radio equipment, use the power supply and antenna connections intended for use in the basic wiring. Be sure to observe the manufacturer's additional instructions during installation.

Deviations with respect to wavebands, maximum transmission outputs or antenna positions must be approved by smart.

 Damage or consequential damage arising from retrofitting RF transmitters in the

vehicle, is not covered by the smart warranty.

The maximum transmission output (PEAK) at the base of the antenna must not exceed the following values:

Waveband	Maximum transmission output
Tetra 380 – 410 MHz	20 W
Mobile communications generation 2G/3G/4G	6 W

The following can be used in the vehicle without restrictions:

- RF transmitters with a maximum transmission output of up to 100 mW
- Mobile phones (2G/3G/4G)

There is no restriction for antenna positions on the outside of the vehicle for the following wavebands:

- Tetra
- Mobile communications (2G/3G/4G)

